

Installation Instructions for
Heating & Air Conditioning
1F72
5/2 Day Programmable
Heat Pump Thermostat

CONTENTS

Preparations..... 1
Thermostat Details 1
Removing Old Thermostat..... 1-2
Mounting and Wiring..... 2-3
Check Thermostat Operation..... 4-5
Programming your Thermostat 6-7
Specifications 7
Troubleshooting 7-8

YOUR THERMOSTAT REPLACES

Description	
Heat Pump (No Aux or Emergency Heat)	Yes
Heat Pump (with Aux or Emergency Heat)	Yes
Standard Heat & Cooling Systems	No
Standard Heat Only Systems	No
Millivolt Heat Only Systems – Floor or Wall Furnaces	No
Standard Central Air Conditioning	No
Gas or Oil Heat	No
Electric Furnace	No
Hydronic (Hot Water) Zone Heat – 2 Wires	No
Hydronic (Hot Water) Zone Heat – 3 Wires	No

1 PREPARATIONS

Assemble tools required as shown below.

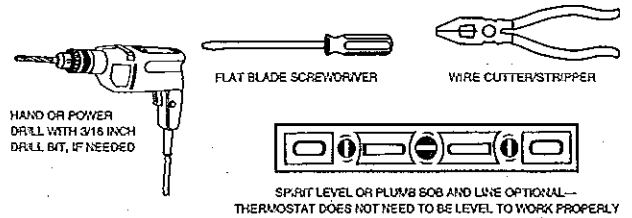

Failure to follow and read all instructions carefully before installing or operating this control could cause personal injury and/or property damage.

2 THERMOSTAT DETAILS

3 REMOVING OLD THERMOSTAT

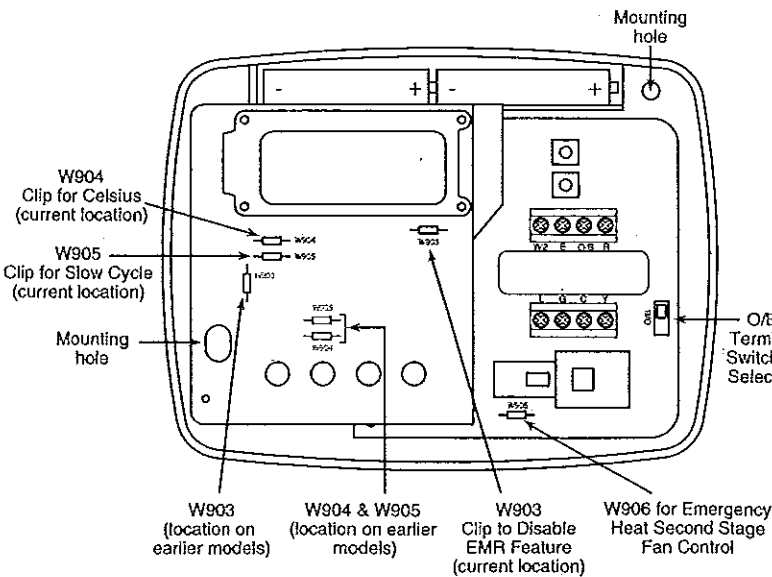

Figure 1. Thermostat base

CAUTION

To prevent electrical shock and/or equipment damage, disconnect electrical power to the system at the main fuse or circuit breaker until installation is complete.

Before removing wires from old thermostat's switching subbase, label each wire with the terminal designation it was removed from.

- Remove Old Thermostat:** A standard heat/cool thermostat consists of three basic parts:
 - The cover, which may be either a snap-on or hinge type.
 - The base, which is removed by loosening all captive screws.
 - The switching subbase, which is removed by unscrewing the mounting screws that hold it on the wall or adaptor plate.
- Shut off electricity at the main fuse box until installation is complete. Ensure that electrical power is disconnected.
- Remove the front cover of the old thermostat. **With wires still attached**, remove wall plate from the wall. If the old thermostat has a wall mounting plate, remove the thermostat and the wall mounting plate as an assembly.
- Identify each wire attached to the old thermostat using the labels enclosed with the new thermostat.
- Disconnect the wires from the old thermostat one at a time. **DO NOT LET WIRES FALL BACK INTO THE WALL.**
- Install new thermostat using the following procedures.

3 REMOVING OLD THERMOSTAT

CONTINUED FROM FIRST PAGE

ATTENTION! This product does not contain mercury. However, this product may replace a unit which contains mercury.

Do not open mercury cells. If a cell becomes damaged, do not touch any spilled mercury. Wearing non-absorbent gloves, take up the spilled mercury and place into a container which can be sealed. If a cell becomes damaged, the unit should be discarded.

Mercury must not be discarded in household trash. When the unit this product is replacing is to be discarded, place in a suitable shipping container. Refer to www.white-roddgers.com for location to send the product with mercury.

4 MOUNTING AND WIRING

⚠ WARNING

Do not use on circuits exceeding specified voltage. Higher voltage will damage control and could cause shock or fire hazard.

Do not short out terminals on gas valve or primary control to test. Short or incorrect wiring will damage thermostat and could cause personal injury and/or property damage.

Thermostat installation and all components of the system shall conform to Class II circuits per the NEC code.

Electric/Gas Jumper (Fan Option)

If your emergency or auxiliary system will energize the blower, then jumper W906 on the thermostat base must be cut (see fig. 1).

If your emergency or auxiliary heat system requires that the thermostat energize the fan circuit, do not cut jumper W906.

If you are unsure of your application, contact a qualified serviceperson.

°F or °C Selection

The factory default setting for temperature display is Fahrenheit. If you want the temperature in Celsius, clip jumper W904.

Fast or Slow Cycle Selection

The factory default setting is fast cycle, which cycles 1st stage at approximately 1.2°F and 2nd stage 0.75°F. If you prefer slow cycle, clip jump W905. The 1st stage and 2nd stage would be 1.5°F and 1.2°F respectively.

Energy Management Recovery (EMR)

This thermostat is set to operate with EMR. This causes the thermostat to start the heating or cooling system early to have the room temperature reach the program setpoint at the time the period is to start.

To disable EMR, clip jumper W903 (see Fig. 1).

O/B Terminal Switch Selection

The O/B switch on this thermostat is factory set to "O" position. This will accommodate the majority of heat pump applications, which require the changeover relay to be energized in COOL. If the thermostat you are replacing or the heat pump being installed with this thermostat requires a "B" terminal, to energize the changeover relay in HEAT, the O/B switch must be moved to the "B" position.

⚠ CAUTION

Take care when securing and routing wires so they do not short to adjacent terminals or rear of thermostat. Personal injury and/or property damage may occur.

Attach Thermostat Base to Wall

1. Remove the packing material from the thermostat. Gently pull the cover straight off the base. Forcing or prying on the thermostat will cause damage to the unit.
2. Connect wires beneath terminal screws on base using appropriate wiring schematic (see figs. 2 through 4).
3. Place base over hole in wall and mark mounting hole locations on wall using base as a template.
4. Move base out of the way. Drill mounting holes.
5. Fasten base loosely to wall, as shown in fig. 1, using two mounting screws. Place a level against bottom of base, adjust until level, and then tighten screws. (Leveling is for appearance only and will not affect thermostat operation.) If you are using existing mounting holes, or if holes drilled are too large and do not allow you to tighten base snugly, use plastic screw anchors to secure subbase.
6. Push excess wire into wall and plug hole with a fire-resistant material (such as fiberglass insulation) to prevent drafts from affecting thermostat operation.

Battery Location

This thermostat does not require batteries to operate. The 2 "AAA" alkaline batteries are for the thermostat to remember the programming if AC voltage is lost. If the display shows **BATT** or **CHANGE**  when AC power is not present, the batteries are low and should be replaced with fresh "AAA" alkaline batteries. For best results, replace all batteries with new premium brand alkaline batteries such as Duracell® or Energizer®. To replace the batteries, install the batteries along the top of the base (see fig. 1). The batteries must be installed with the positive (+) ends to the right.

4 MOUNTING AND WIRING

CONTINUED FROM SECOND PAGE

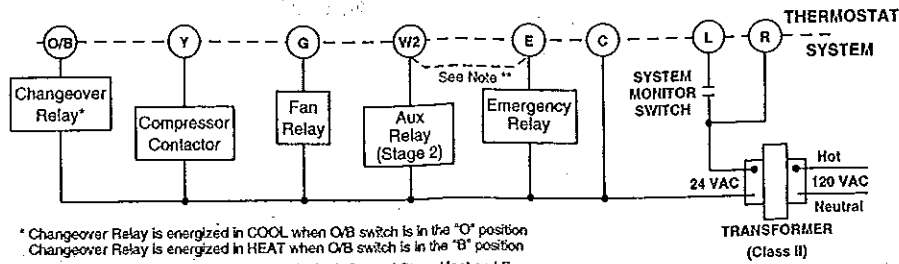

Figure 2. Typical wiring diagram for single transformer systems

NOTE
 If safety circuits are in only one of the systems, remove the transformer of the system with NO safety circuits.

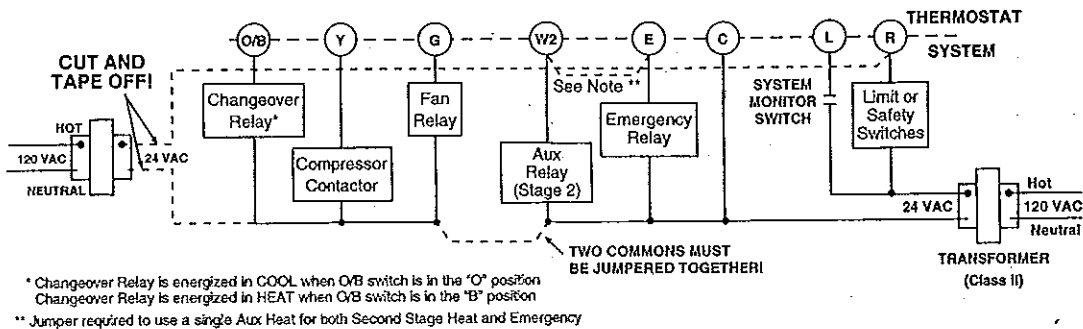

Figure 3. Typical wiring diagram for two transformer systems with NO safety circuits

NOTE
 Polarity must be observed. If the HOT side of the second transformer is jumpered to the COMMON side of the first transformer a short will be made. Damage to equipment will occur when power is restored.

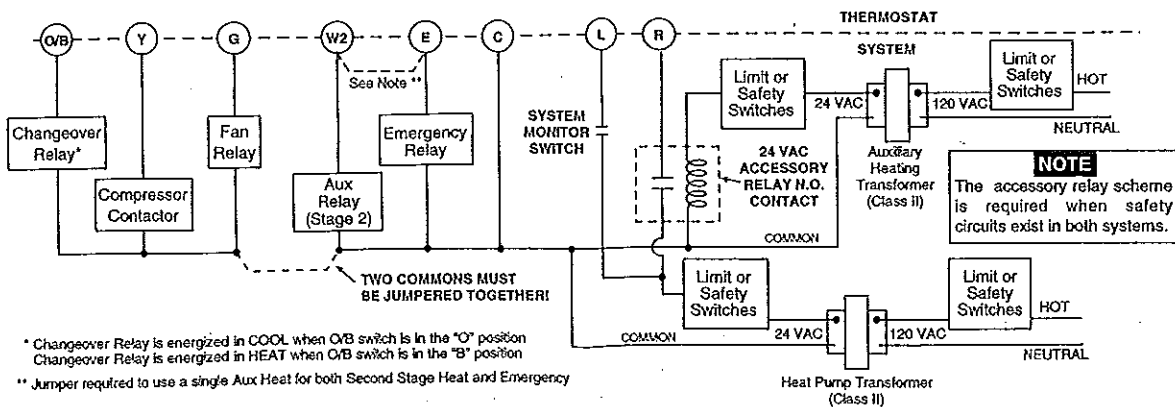

Figure 4. Typical wiring diagram for two transformer systems with safety circuits in BOTH systems

5 CHECK THERMOSTAT OPERATION

NOTE

To prevent static discharge problems, touch side of thermostat to release static build-up before touching any keys.

If at any time during testing your system does not operate properly, contact a qualified serviceperson.

Fan Operation



If your system does not have a G terminal connection, skip to Heating System.

1. Turn on power to the system.
2. Move fan switch to **ON** position. The blower should begin to operate.
3. Move fan switch to **AUTO** position. The blower should stop immediately.

CAUTION



Do not allow the compressor to run unless the compressor oil heaters have been operational for 6 hours and the system has not been operational for at least 5 minutes.

Heating System

1. Move SYSTEM switch to **HEAT** position. If the auxiliary heating system has a standing pilot, be sure to light it.
2. Press  to adjust thermostat setting to 1° above room temperature. The heat pump system should begin to operate. However, if the **Flame icon** (⊕) and **Snowflake icon** (❄) are flashing, the compressor lockout feature is operating (see Configuration menu, item 2.)
3. Adjust temperature setting to 4° above room temperature. The auxiliary heat system should begin to operate and the **Flame icon** (⊕) will be flashing.
4. Press  to adjust thermostat setting below room temperature. The heating system should stop operating.

Emergency System



EMER bypasses the Heat Pump to use the heat source wired to terminal E on the thermostat. EMER is typically used when compressor operation is not desired, or you prefer back-up heat only.

1. Move SYSTEM switch to **EMER** position. EMER will flash on the display.
2. Press  to adjust thermostat setting above room temperature. The Aux heating system will begin to operate. The **Flame icon** (⊕) will display flashing to indicate that the Aux system is operating.
3. Press  to adjust the thermostat below room temperature. The Aux heating system should stop operating.

CAUTION

To prevent compressor and/or property damage, if the outdoor temperature is below 50°F, DO NOT operate the cooling system.

Cooling System

1. Move SYSTEM switch to **COOL** position.
2. Press  to adjust thermostat setting below room temperature. The blower should come on immediately on high speed, followed by cold air circulation.
3. Press  to adjust temperature setting above room temperature. The cooling system should stop operating.

Before you begin programming your thermostat, you should be familiar with its features and with the display and the location and operation of the thermostat buttons. Your thermostat consists of two parts: the **thermostat cover** and the **base**. To remove the cover, gently pull it straight out from the base. To replace the cover, line up the cover with the base and press gently until the cover snaps onto the base.

The Thermostat Buttons and Switches

- 1 (Up arrow) Raises temperature setting.
- 2 (Down arrow) Lowers temperature setting.
- 3 TIME button.
- 4 PRGM (program) button.
- 5 RUN (program) button.
- 6 HOLD button.
- 7 FAN switch (ON, AUTO).
- 8 SYSTEM switch (COOL, OFF, HEAT, EMER).

The Display

- 9 Indicates day of the week.
- 10 Indicates a malfunction with the system.
- 11 **Flame icon** (⊕) is displayed when the SYSTEM switch is in the HEAT position. **Flame icon** (⊕) is displayed flashing when 2nd-stage heat (Aux or Emergency) is energized. **Snowflake icon** (❄) is displayed (non-flashing) when the SYSTEM switch is in the COOL position. **Snowflake** and **Flame icons** will be displayed (flashing) if the thermostat is in lockout mode to prevent the compressor from cycling too quickly.

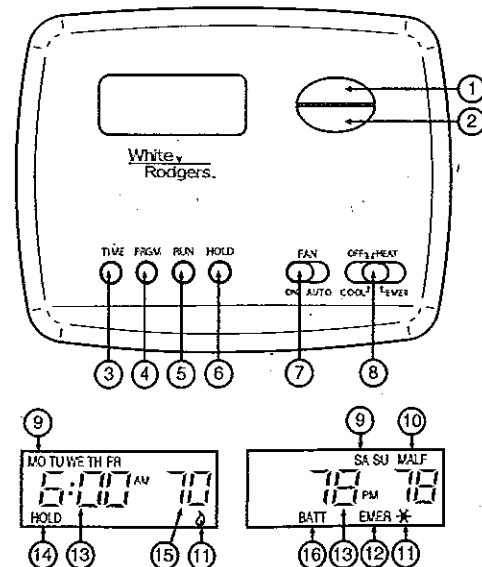



Figure 5. Thermostat display, buttons, and switches

5 CHECK THERMOSTAT OPERATION

CONTINUED FROM FOURTH PAGE

- 12 EMER is displayed flashing when the system switch is in EMER position.
- 13 Alternately displays current time and temperature.
- 14 The word HOLD is displayed when the thermostat is in the HOLD mode.
- 15 Displays currently programmed set temperature (this is blank when SYSTEM switch is in the OFF position).
- 16 "BATT" or CHANGE  is displayed when 2 "AAA" batteries are low and should be replaced.

Configuration Menu

The configuration menu allows you to set certain thermostat operating characteristics to your system or personal requirements.

Press RUN to make sure the thermostat is in the run program mode, then press PRGM and RUN at the same time to enter the configuration menu. The display will show the first item in the configuration menu. The configuration menu chart summarizes the configuration options. An explanation of each option follows.





Press HOLD to change to the next menu item or press TIME to go backwards to the previous item in the menu. To exit the menu and return to the program operation, press RUN. If no keys are pressed within fifteen minutes, the thermostat will revert to normal operation.

1. In the run mode, if the setpoint temperature is manually raised by 3°F (2°C) or more above the actual temperature with the TEMPERATURE UP key, and the fast second stage feature is enabled, FA on, the second stage will energize immediately. With FA off, second stage will not energize until the setpoint temperature is 1°F or more above actual temperature for more than ten minutes.
2. **Select Compressor Lockout CL OFF or ON** — Selecting CL ON will cause the thermostat to wait 5 minutes before turning on the compressor if the heating and cooling system loses power. It will also wait 5 minutes minimum between cooling and heating cycles. This is intended to help protect the compressor from short cycling. Some newer compressors already have a time delay built in and do not require this feature. Your compressor manufacturer can tell you if the lockout feature is already present in their system. When the thermostat compressor time delay occurs it will flash the Snowflake and Flame Icons for about five minutes.



3. **Select Temperature Display Adjustment 3 LO to 3 HI** — Allows you to adjust the room temperature display up to 3° higher or lower. Your thermostat was accurately calibrated at the factory but you have the option to change the display temperature to match your previous thermostat. The current or adjusted room temperature will be displayed on the left side of the display.
4. **Select Backlit Display** — (Not available on earlier models) The display backlight improves display contrast in low lighting conditions. Selecting backlight ON will keep the light on continuously. Selecting Backlight OFF will keep the light off.

Operating Features

Now that you are familiar with the thermostat buttons and display, read the following information to learn about the many features of the thermostat.

- **SIMULTANEOUS HEATING/COOLING PROGRAM STORAGE** — When programming, you can enter both your heating and cooling programs at the same time. There is no need to reprogram the thermostat at the beginning of each season.
- **TEMPERATURE OVERRIDE** — Press  or  until the display shows the temperature you want. The thermostat will override current programming and keep the room temperature at the selected temperature until the next program period begins. Then the thermostat will automatically revert to the program.
- **HOLD TEMPERATURE** — The thermostat can hold any temperature within its range for an indefinite period, without reverting to the programmed temperature. Press HOLD button. HOLD will be displayed. Then choose the desired temperature by pressing  or . The thermostat will hold the room temperature at the selected setting until you press the RUN button to start program operation again.
- **ENERGY MANAGEMENT RECOVERY** — Energy Management Recovery (EMR) causes the thermostat to start heating or cooling early to make the building temperature reach the program setpoint at the time you specify. Heating will start 5 minutes early for every 1° of temperature required to reach setpoint.
Example: You select EMR and have your heating programmed to 65° at night and 70° at 7 AM. If the building temperature is 65° the difference between 65° and 70° is 5°. Allowing 5 minutes per degree the thermostat setpoint will change to 70° at 6:35 AM. Cooling allows more time per degree because it takes longer to reach temperature.
- **°F/°C CONVERTIBILITY** — The factory default setting is Fahrenheit. Clipping W904 jumper on the circuit board (see fig. 1) will alter this feature to Celsius temperature setting.

Configuration Menu

Step	Press Button(s)	Displayed (Factory Default)	Press  or  to select:	COMMENTS
1	PRGM and RUN	FA (on)	OFF	Select Fast (on) or slow (off) Second Stage Heat
2	HOLD*	CL (OFF)	ON	Select Compressor lockout OFF or ON
3	HOLD*	0 HI (0)	3 LO TO 3 HI	Select temperature display adjustment higher or lower
4**	HOLD*	dL (ON)	OFF	Select display backlight OFF or ON
5	RUN			Returns to normal operation

* Press HOLD to advance to next item or TIME to move backwards to previous item

** Not available on earlier models

6 PROGRAMMING YOUR THERMOSTAT

This section will help you plan your thermostat's program to meet your needs. For maximum comfort and efficiency, keep the following guidelines in mind when planning your program.

- When heating (cooling) your building, program the temperatures to be cooler (warmer) when the building is vacant or during periods of low activity.
- During early morning hours, the need for cooling is usually minimal.

Look at the factory preprogrammed times and temperatures shown below. If this program will suit your needs, simply press the RUN button to begin running the factory preset program.

If you want to change the preprogrammed times and temperatures, follow these steps.

Determine the time periods and temperatures for your weekday and weekend programs. You must program four periods for both the weekday and weekend program. However, you may use the same heating and cooling temperatures for consecutive time periods. You can choose start times, heating temperatures, and cooling temperatures independently for both weekday and weekend programs (for example, you may select 5:00 AM and 70° as the weekday 1st period heating start time and temperature, and also choose 7:00 AM and 76° as the weekday 1st period cooling start time and temperature). Use the table at the bottom of the page to plan your program time periods and the temperatures you want during each period. You may also want to look at the sample program table to get an idea of how the thermostat can be programmed.

Entering Your Program

Follow these steps to enter the heating and cooling programs you have selected.

Set Current Time and Day

1. Press TIME button once. The display will show the hour only.



2. Press and hold either or until you reach the correct hour and AM/PM designation (AM begins at midnight; PM begins at noon).

3. Press TIME once. The display window will show the minutes only.



4. Press and hold either or until you reach the correct minutes.
5. Press TIME once. The display will show the day of the week.
6. Press or until you reach the current day of the week.
7. Press RUN once. The display will show the correct time and room temperature alternately.

Enter Heating Program

1. Move the SYSTEM switch to HEAT.
2. Press PRGM once. "MO TU WETH FR" (indicating weekday program) will appear in the display. Also displayed are the currently programmed start time for the 1st heating period and the currently programmed temperature (flashing).

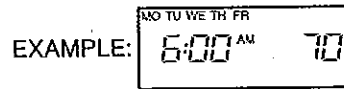

This display window shows that for the 1st weekday period, the start time is 6:00 AM, and 70° is the programmed temperature (this example reflects factory preprogramming).

3. Press or to change the displayed temperature to your selected temperature for the 1st heating program period.
4. Press TIME once (the programmed time will flash). Press or until your selected time appears. The time will change in 15 minute increments. When your selected time is displayed, press TIME again to return to the change temperature mode.
5. Press PRGM once. The currently programmed start time and setpoint temperature for the 2nd heating program period will appear.
6. Repeat steps 4 and 5 to select the start time and heating temperature for the 2nd heating program period.
7. Repeat steps 4 through 6 for the 3rd and 4th heating program periods. Weekday heating programs are now complete.
8. Press PRGM once. "SA SU" (indicating weekend program) will appear in the display, along with the start time for the 1st heating period and the currently programmed temperature.

SAMPLE Heating/Cooling Schedule Plan (Factory Program)

Period	WEEKDAY (5 DAY)		WEEKEND (2 DAY)		
	Start Time	Temperature	Start Time	Temperature	
HEAT	1ST	6:00 AM	70°F	6:00 AM	70°F
	2ND	8:00 AM	62°F	8:00 AM	62°F
	3RD	5:00 PM	70°F	5:00 PM	70°F
	4TH	10:00 PM	62°F	10:00 PM	62°F
COOL	1ST	6:00 AM	78°F	6:00 AM	78°F
	2ND	8:00 AM	85°F	8:00 AM	85°F
	3RD	5:00 PM	78°F	5:00 PM	78°F
	4TH	10:00 PM	82°F	10:00 PM	82°F

Heating/Cooling Schedule Plan

Period	WEEKDAY (5 DAY)		WEEKEND (2 DAY)	
	Start Time	Temperature	Start Time	Temperature
HEAT	1ST			
	2ND			
	3RD			
	4TH			
COOL	1ST			
	2ND			
	3RD			
	4TH			

6 PROGRAMMING YOUR THERMOSTAT CONTINUED FROM SIXTH PAGE

9. Repeat steps 4 through 8 to complete weekend heating programming.
10. When you have completed entering your heating program, press RUN.

Enter Cooling Program

If the outside temperature is below 50°F, disconnect power to the cooling system before programming. Energizing the air conditioner compressor during cold weather may cause personal injury or property damage.

1. Move SYSTEM switch to COOL position.
2. Follow the procedure for entering your heating program, using your selected cooling times and temperatures.

Check Your Programming

Follow these steps to check your thermostat programming one final time before beginning thermostat operation.

1. Move SYSTEM switch to HEAT position.
2. Press PRGM to view the 1st weekday heating period time and temperature. Each time you press PRGM, the next heating period time and temperature will be displayed in sequence for weekday, then weekend program periods (you may change any time or temperature during this procedure).
3. Press RUN.
4. Move SYSTEM switch to COOL position.
5. Repeat step 2 to check cooling temperatures.
6. Press RUN to begin program operation.

YOUR THERMOSTAT IS NOW COMPLETELY PROGRAMMED AND READY TO AUTOMATICALLY PROVIDE MAXIMUM COMFORT AND EFFICIENCY!

7 SPECIFICATIONS

ELECTRICAL DATA

Electrical Rating:

- 20 to 30 VAC 50/60 Hz.
- 0.05 to 1.0 Amps (Load per terminal)
- 1.5 Amps Maximum Total Load (All terminals combined)

THERMAL DATA

Setpoint Temperature Range:

45°F to 90°F (7°C to 32°C)

Operating Ambient Temperature Range:

32°F to 105°F

Operating Humidity Range:



0 to 90% RH (non-condensing)

Shipping Temperature Range:

-40°F to 150°F

8 TROUBLESHOOTING

Reset Operation

If a voltage spike or static discharge blanks out the display or causes erratic thermostat operation you can reset the thermostat by pressing  and  and TIME at the same time. This also resets the factory defaults. If the thermostat has power, has been reset

and still does not function correctly contact your heating/cooling service person or place of purchase.

Batteries

For optimum performance, we recommend replacing batteries once a year with fresh "AAA" alkaline batteries.

Symptom	Possible Cause	Corrective Action
No Heat/No Cool/No Fan (common problems)	<ol style="list-style-type: none"> 1. Blown fuse or tripped circuit breaker. 2. Furnace power switch to OFF. 3. Furnace blower compartment door or panel loose or not properly installed. 	<p>Replace fuse or reset breaker. Turn switch to ON. Replace door panel in proper position to engage safety interlock or door switch.</p>
No Heat	<ol style="list-style-type: none"> 1. Pilot light not lit. 2. System Switch not set to HEAT. 3. Loose connection to thermostat or system. 4. Furnace Lock-Out Condition. Heat may also be intermittent. 	<p>Re-light pilot. Set System Switch to HEAT and raise setpoint above room temperature. Verify thermostat and system wires are securely attached. Many furnaces have safety devices that shut down when a lock-out condition occurs. If the heat works intermittently contact the furnace manufacturer or local service person for assistance.</p>

8 PROGRAMMING YOUR THERMOSTAT

CONTINUED FROM SEVENTH PAGE

Symptom	Possible Cause	Corrective Action
No Heat (continued)	5. Heating system requires service or thermostat requires replacement.	Diagnostic: Set System Switch to HEAT and raise the setpoint above room temperature. Within a few seconds the thermostat should make a soft click sound. This sound usually indicates the thermostat is operating properly. If the thermostat does not click, try the reset operation listed above. If the thermostat does not click after being reset contact your heating and cooling service person or place of purchase for a replacement. If the thermostat clicks, contact the furnace manufacturer or a service person to verify the heating is operating correctly.
No Cool	1. System Switch not set to COOL. 2. Loose connection to thermostat or system. 3. Cooling system requires service or thermostat requires replacement.	Set System Switch to COOL and lower setpoint below room temperature. Verify thermostat and system wires are securely attached. Same procedure as diagnostic for No Heat condition except set the thermostat to COOL and lower the setpoint below the room temperature. There may be up to a five minute delay before the thermostat clicks in Cooling.
Heat, Cool or Fan Runs Constantly.	1. Possible short in wiring. 2. Possible short in thermostat. 3. Possible short in heat/cool/fan system. 4. Fan Switch set to Fan On.	Check each wire connection to verify they are not shorted or touching together. No bare wire should stick out from under terminal screws. Try resetting the thermostat as described above. If the condition persists the manufacturer of your system or service person can instruct you on how to test the Heat/Cool system for correct operation. If the system operates correctly, replace the thermostat.
Furnace (Air Conditioning) Cycles Too Fast or Too Slow (narrow or wide temperature swing)	1. The location of the thermostat and/or the size of the Heating (Cooling) System may be influencing the cycle rate.	Digital thermostats normally provide precise temperature control and may cycle faster than some older mechanical models. A faster cycle rate means the unit turns on and off more frequently but runs for a shorter time so there is no increase in energy use. If you would like to increase the cycle time, clip Jumper W-905 as mentioned in the instructions for Hydronic Heating Systems. It is not possible to shorten the cycle time. If an acceptable cycle rate is not achieved as received or by clipping W-905 contact a local service person for additional suggestions.
Thermostat Setting and Thermostat Thermometer Disagree	1. Thermostat thermometer setting requires adjustment.	Thermostat thermometer can be adjusted +/-3 degrees. See Temperature Display Adjustment in the Operation section
Thermostat Does Not Follow Program	1. AM or PM set incorrectly in program. 2. AM or PM set incorrectly on the clock. 3. Voltage spike or static discharge..	Check current clock and program settings including the AM or PM designations for each time period. If a voltage spike or a static discharge occurs use the Reset Operation listed above.
Blank Display and/or Keypad Not Responding	1. Voltage spike or static discharge,	Use the Reset Operation listed above.

HOMEOWNER HELP LINE: 1-800-284-2925

White
Rodgers.

White-Rodgers is a division of Emerson Electric Co.

The Emerson logo is a trademark and service mark of Emerson Electric Co.

www.white-rodgers.com
www.emersonclimate.com

EMERSON
Climate Technologies