



A NIBE GROUP MEMBER



RESIDENTIAL TRANQUILITY® 30 (SE) PREMIER TWO-STAGE SERIES PRODUCT CATALOG

Part#: RP3001 | Revised: February 19, 2025

Models: SE 024-072
60Hz - R-454B



3	Introduction	31	Antifreeze Correction Table
5	Features, Options, and Accessories	33	Water Pressure Drop Adder for Options: Correction Tables
6	iGate 2 Communicating Controls Powered by DXM2.5	34	Physical Data
7	Communicating (AWC) Thermostat	35	Dimensional Data
8	myUplink: Web and Mobile Interface	39	Horizontal Dimensional Data
9	vFlow Internal Variable Water Flow Control	40	Horizontal Service Access
11	Selection Procedure	41	Vertical Upflow Dimensional Data
13	Model Nomenclature	42	Vertical Downflow Dimensional Data
14	Performance Data: AHRI/ASHRAE/ISO 13256-1	43	Vertical Service Access
16	Performance Data: Selection Notes	44	Minimum Installation Area
17	Performance Data	45	Electrical Data: CV EC Blower Motor
27	Blower Performance: CV EC Standard Unit	46	Accessories and Options
28	Part Load Performance: Correction Tables	47	Warranty
29	Full Load Performance: Correction Tables	48	Revision History
30	High Head and Standard Variable Pump Performance		

THE TRANQUILITY® 30 (SE) PREMIER TWO-STAGE SERIES

The Tranquility 30 (SE) Premier Two-Stage Series showcases superb efficiency ratings, quiet operation, and application flexibility that is synonymous with the ClimateMaster Tranquility family. The Tranquility SE surpasses ASHRAE 90.1 efficiency standards and utilizes R-454B low Global Warming Potential (GWP) refrigerant, setting a high standard for eco-friendly performance. The SE is Energy Star certified due to its innovative and environmentally conscious design.

Available in sizes 2 tons (7.0 kW) through 5 tons (21.1 kW) with multiple cabinet options (vertical upflow, vertical downflow, and horizontal) the Tranquility SE offers a wide range of units for most any installation. The Tranquility SE has an extended range refrigerant circuit, capable of ground loop (geothermal) applications as well as open loop applications. Some of the features of the innovative Tranquility SE series include: ultra-efficient Two-Stage unloading scroll compressor, EC variable fan motor, microprocessor controls, galvanized steel cabinet construction, corrosive-resistant stainless-steel drain pan, and acoustic type fiber insulation are just some of the features of the innovative Tranquility SE Series.

Recent EPA mandates require an industry transition to low-GWP refrigerants, such as R-454B which is a gas that is classified as having low-toxicity, low-flammability rating. Due to these characteristics, R-454B systems charged with over 62 ounces of refrigerant must contain an integrated Refrigerant Detection System (RDS). In the unlikely event of a system-refrigerant leak, the RDS shuts down compressor operation and runs the unit blower motor to disperse any concentration of leaked refrigerant in compliance with UL 60335-2-40 safety standards. For Tranquility SE products, only the 5- and 6-ton sizes (060 and 072) are required to have the RDS and the feature is optional on all other sizes.

ClimateMaster's double isolation compressor mounting system makes the Tranquility SE one of the quietest units on the market. Compressors are mounted using specially engineered sound tested EPDM grommets to a heavy gauge mounting plate, which is then isolated from the cabinet base with EPDM grommets to minimize vibration transmission and maximize sound attenuation. Multiple removable access panels and an easily accessible control box make installation and maintenance user friendly. Options such as coated air coil, internal variable speed pump, modulating water valve, and high efficiency MERV rated air filters allow for customizable design solutions.

iGate® 2 technology provides technicians an interface into the operation of the system in real time without the need for hard tooling. On-board advanced controls communicate the key operating system temperatures allowing technicians to startup, commission, and service equipment remotely by smart phone or website interface. Communication can also be established at the unit via a communicating thermostat or Wireless Service Tool. Not only does iGate 2 monitor current performance, it also allows the functionality to make system adjustments and captures operating conditions at time of fault. The data is presented in a user-friendly format, enhancing the overall usability of the experience.

vFlow® is ClimateMaster's variable water flow technology. It represents a major advancement in water flow system management efficiency. vFlow not only builds major water circulation components into the unit for a clean installation, it also intelligently varies water flow to minimize pump energy consumption and improve system reliability.

The heart of vFlow is either a variable-speed pump or modulating water valve intelligently controlled with DXM2.5 Advanced Communicating Controls. Water flow is automatically varied based on changes in unit capacity level (stage) and source water temperature to maintain optimum system performance. vFlow allows the use of direct return piping, while eliminating external two-way valves and automatic flow regulators, making vFlow systems inherently self-balancing.

vFlow systems provide reduced water pumping power compared to traditional fixed-speed pumping systems. They also protect the unit against extreme operating conditions, thus extending the life of the compressor and air coil. Since vFlow is built inside the unit, it also saves on installation time and makes for a very clean and compact installation. The Tranquility SE Series water-source heat pumps are designed to meet the challenges of today's HVAC demands with one of the most innovative products available on the market.

FEATURES

- Sizes 024 (2 ton, 7 kW) through 072 (6 tons, 21.1 kW)
- Exceeds ASHRAE 90.1 efficiency standards
- Environmentally-friendly R-454B low-GWP refrigerant
- Refrigerant Detection System (RDS) (mandatory on sizes 060 and 072, optional feature for sizes 024-048)
- Intelligent variable speed Constant Volume (CV) EC blower motors for precise airflow control and soft-start feature
- Part-load operation significantly lowers annual operating costs
- Galvanized-steel cabinet construction with matte black polyester powder coated finish and stainless-steel access panels
- Sound-absorbing glass-fiber insulation
- Unique double-isolation compressor mounting with vibration isolation for quieter operation
- Insulated divider and separate compressor/air-handler compartments
- TXV metering device
- Field-convertible supply-air arrangement (horizontal configurations only)
- Unit Performance Sentinel performance-monitoring system
- Eight standard safety features
- Easy-to-clean rust-prohibitive stainless-steel drain pans
- Communicating Controls Powered by DXM2.5:
 - Multiple communication pathways for unit access and diagnosis:
 - Cloud-based remote monitoring via iGate 2 Communicating (AWC) Thermostat
 - Connect directly to the system with the Wireless Service Tool
 - Provides real-time unit operating conditions
 - Reduces startup, commissioning, and service time by providing key system temperatures electronically
 - Captures operating conditions in the event of a safety shutdown
- Anti-short cycle and over/under-voltage protection
- Easy-access control box
- High-pressure, loss-of-charge, and condensate-overflow protection
- LED fault and status indication at controller
- Tin-plated air coils for added protection from formicary corrosion (060 - 072)
- Aluminum Microchannel air coils for added protection and improved efficiency (024 - 048)
- Extended-range insulation for geothermal applications
- Return-air filter frames for 2-inch MERV 11 filter

OPTIONS

- Corrosion-resistant cupro-nickel water-heat exchanger
- Domestic Hot Water Generator (HWG)
- vFlow unit-integrated variable-speed water pump
- vFlow unit-integrated modulating water valve for maximum water-flow control (replaces traditional motorized water valve and autoflow regulator)
- Factory-installed compressor soft starter to reduce inrush currents for more efficient startups
- Integrated power disconnect

ACCESSORIES

- iGate 2 Communicating (AWC) Thermostat with color touchscreen
- Wide variety of thermostat options to meet your application needs
- Auxiliary electric heaters

iGate 2 Communicating Controls Powered by DXM2.5 Advanced Communicating Controls

Models:
SE
024-072

iGATE 2 COMMUNICATION – CLOUD CONNECTED, WEB-ENABLED INFORMATION GATEWAY TO MONITOR, CONTROL, AND DIAGNOSE YOUR SYSTEM

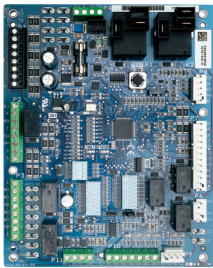

The Tranquility SE is equipped with industry-first, iGate 2 communication information gateway that allows users to interact with their water-source system in easy to read clear language AND delivers improved reliability and efficiency by precisely

controlling smart components.

Monitor/Configure – From the myUplink PRO website, mobile app, AWC Thermostat, or Wireless Service Tool, installers can configure the following: airflow, unit family, size, accessory configuration, and demand reduction (optional, to limit unit operation during peak times). Users can look up the current system status: temperature sensor readings and operational status of the blower.

Precise Control – The DXM2.5 enables intelligent, two-way communication between the DXM2.5 and smart components like the AWC Thermostat, Wireless Service Tool, and constant volume CV EC blower motor. DXM2.5 Advanced Communicating Controls uses information received from the smart components and temperature sensors to precisely control operation of the variable speed CV EC fan to deliver higher efficiency, reliability and increased comfort.

Diagnostics – iGate 2 takes diagnosing water-source heat pump units to a next level of simplicity, by providing a dashboard of system and fault information, in clear language, on the AWC Thermostat, Wireless Service Tool, and the web portal/mobile app on the internet.

iGate 2 Service Warnings notify the homeowner and contractor of a fault and displays fault descriptions by app notifications and email with possible causes. Additionally, the current system status can be viewed graphically on the web portal and mobile app.

In iGate 2 Service Mode, the service personnel can access fault description, possible causes and most importantly, the conditions (temp, flow, i/o conditions, configuration) at the time of the fault. Manual Operation mode allows the service personnel to manually command operation for any of the thermostat outputs, blower speed, to help troubleshoot specific components. This operation can either be conducted at the unit with a Wireless Service Tool or remotely with mobile app/website when AWC Thermostat controls are used.

With an iGate 2 communicating system, users and contractors have a web-enabled gateway to system information never before available and exclusive to ClimateMaster products.

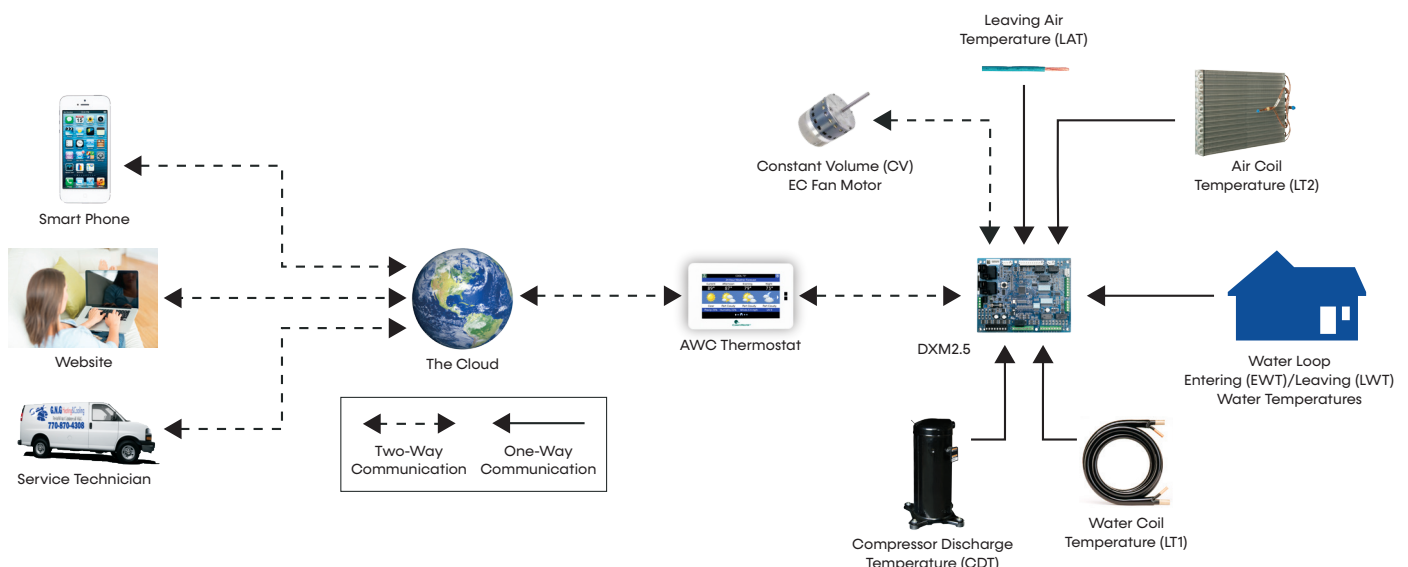

ClimateMaster works continually to improve its products. As a result, the design and specifications of each product at the time of order may be changed without notice and may not be as described herein. Please contact ClimateMaster's Customer Service Department at 800-299-9747 for specific information on the current design and specifications. Statements and other information contained herein are not express warranties and do not form the basis of any bargain between the parties, but are merely ClimateMaster's opinion or commendation of its products. The latest version of this document is available at www.climatemaster.com. Engineered and assembled in the USA. © ClimateMaster, Inc. All Rights Reserved 2024

Communicating (AWC) Thermostat

iGATE 2 COMMUNICATION – CLOUD CONNECTED, WEB-ENABLED INFORMATION GATEWAY TO MONITOR, CONTROL, AND DIAGNOSE YOUR SYSTEM

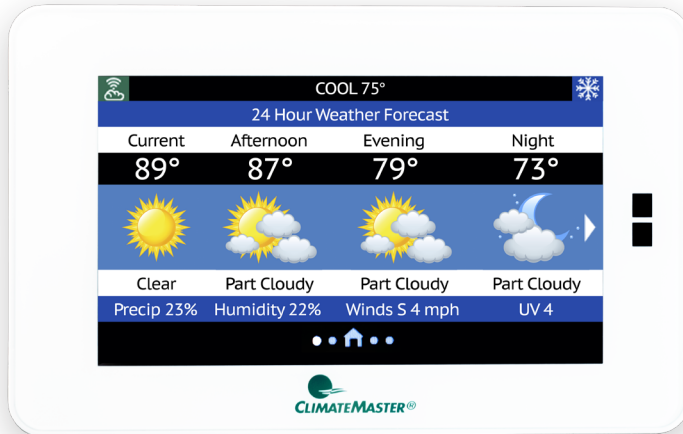

The iGate 2 Communicating (AWC) Thermostat is innovating the future of comfort technology, one building at a time. The inspired design of the touch screen interface allows you to see real-time data for the efficiency and health of your system, with early warnings for potential system faults. The cloud based information gateway allows technicians to remotely diagnose system issues before occupants even know there is a problem. Control and monitor the system in your home or business from anywhere in the world with an easy to use app on your phone.

Features with Efficiency in Mind



Touchscreen Interface

A brilliantly customizable touchscreen monitor for simple control.



Seamless Integration

Between your AWC Thermostat and comfort system.



(Mobile) Remote System Control

Control temperature and schedule from anywhere in the world.



Early Fault Warnings

Alerts the building owner and the contractor of potential system faults in the future.



Remote Diagnostics

Enable the contractor to remotely diagnose system issues, adjust system settings, and reset faults.



Real-Time Operations Data and System Schematics

Access simply via the myUplink Pro Account and web portal to view system diagrams with current operating temperatures.



Revenue Stream

HVAC professionals can offer owners service contracts with remote monitoring and diagnostic capabilities without the large expense of a building management system.



ClimateMaster works continually to improve its products. As a result, the design and specifications of each product at the time of order may be changed without notice and may not be as described herein. Please contact ClimateMaster's Customer Service Department at 800-299-9747 for specific information on the current design and specifications. Statements and other information contained herein are not express warranties and do not form the basis of any bargain between the parties, but are merely ClimateMaster's opinion or commendation of its products. The latest version of this document is available at www.climatemaster.com. Engineered and assembled in the USA. © ClimateMaster, Inc. All Rights Reserved 2024

HVAC Professional | User Experience

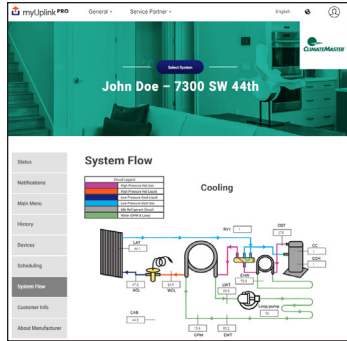

iGate 2 establishes a two-way link between the AWC Thermostat and the cloud, adding significant value for both residential and commercial customers. Our new thermostat works with your customers' Tranquility comfort systems to

provide the most efficient link between their system and your services. The customizable monitoring from the myUplink PRO web portal or phone app account allows for continuous system monitoring, analysis, repair recognition, and early warnings for potential system faults that are sent to you and your customer.



Benefits

- Remote login from anywhere, anytime from any internet connected device
- View system fault history with possible root causes
- Information is available for contractors to troubleshoot and diagnose systems remotely
- Secure internet connection keeps homeowner information private
- Access thermostat(s) through Android and iPhone mobile apps

Homeowner | User Experience

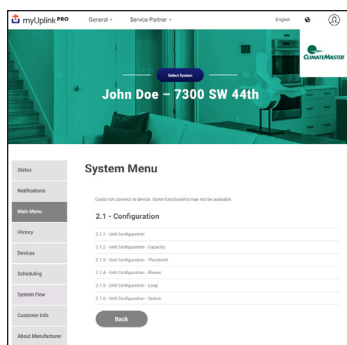

iGate 2 advanced unit controls enable a two-way communication link for critical system information between the unit and the cloud. From any internet connected device or smart phone, building owners can control and monitor their systems

from anywhere in the world. iGate 2 offers building owners peace of mind their systems are operating at peak performance with advanced operational performance issue notifications. HVAC professionals get notifications when systems are operating out of range. They can log in remotely to check system faults, review current operating conditions, and diagnose issues remotely. This gives the HVAC technician the upper hand when showing up to perform service, saving time which in turn, saves money.



Benefits

- Communicates personal settings and reminders through the iGate 2 communication system
- Easy-to-use, full-color, high-resolution user interface
- Sleek, intuitive control panel
- Secure internet connection keeps your information private
- Contains unit model, serial number and your HVAC professionals contact information
- System monitoring automatically contacts HVAC system providers when service is needed

vFLOW INTERNAL VARIABLE WATER FLOW

Industry-first, Built-in vFlow replaces a traditionally inefficient, external component of the system (water circulation) with an ultra-high-efficient, variable speed, internal water flow system. This saves 70-80% on water circulation compared to traditional single speed pump systems. Multi-unit installations are also much simpler with vFlow systems, as the units automatically adjust water flow across the system.

vFlow is enabled by iGate 2, which facilitates intelligent communication between the thermostat, DXM2.5 Advanced Communicating Controls, sensors, and internal water pump/valve to make true variable water flow a reality.

vFLOW IS AVAILABLE IN FOUR VARIATIONS:

- 1. Low System Pressure Drop Modulating Valve**
The high CV motorized valve is used for a multi-unit or central pumping, closed loop application.
- 2. High System Pressure Drop Modulating Valve**
Motorized valve for higher pressure water systems such as a water well or other open loop applications. A cupro-nickel water coil is standard with this option.
- 3. Standard Head Variable Pump Internal Flow Controller**
Multi-unit or central pumping for a closed loop application. The Internal Flow Controller includes a variable speed pump, flushing ports, 3-way flushing valves, and an expansion tank.
- 4. High Head Variable Pump Internal Flow Controller**
Multi-unit or individual unit for a closed loop application. The Internal Flow Controller includes a variable speed pump, flushing ports, 3-way flushing valves, and an expansion tank.

vFLOW DELIVERS THREE MAIN BENEFITS:

1. Easier and quicker unit installation as the flow control is built in to the unit.
2. Superior reliability by varying the water flow to deliver more stable operation.
3. Increased cost savings by varying the flow (and pump watt consumption) to match the unit's mode of operation.

INTERNAL COMPONENTS

All Tranquility products can be installed more easily and compactly than their predecessors because vFlow components are internal to the unit. They also save installing contractors labor and time by eliminating the need for an external flow regulator or a bulky external pumping module.

VARIABLE FLOW

vFlow technology enables variable water flow through the unit, with the DXM2.5 adjusting the pump speed to maintain an installer-set loop ΔT . By controlling the water flow, the system is able to operate at its optimal capacity and efficiency. vFlow provides a lower flow rate for part load where units typically operate 80% of the time and a higher, more normal flow rate for full load operation.

Variable speed pump or motorized modulating valve delivers variable water-flow, controlled by DXM2.5, based on loop water ΔT .



ENERGY SAVINGS WITH WATER CIRCULATION CONTROL

Units with vFlow deliver greater operating cost savings by varying the water flow to match the unit's operation (ex: lower water flow when unit is in part load operation). Lowering the flow results in lower energy consumption by the water pump and cost savings in vFlow units (whether internal or external pump).

In applications using vFlow with internal variable speed electronically commuted (EC) pump, the EC pump uses fewer watts than a fixed speed (PSC) pump even at full load. The EC pump excels in energy savings in part load, saving 70-80% watts compared to fixed speed pumps (see chart). The EC pump can operate with independent flow rates for both heating and cooling operations allowing for more energy savings.

In loop applications, when the motorized modulating valve slows down the water flow during part load operation, the external pump consumes fewer watts, thus saving more energy.

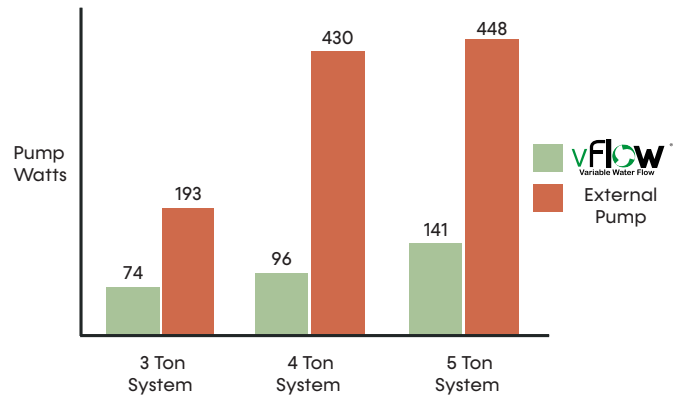

Reference Calculations

Heating	Cooling
$LWT = EWT - \frac{HE}{GPM \times \text{Constant}}$	$LWT = EWT + \frac{HR}{GPM \times \text{Constant}} \quad LC = TC - SC$
$LAT = EAT + \frac{HC}{CFM \times 1.08}$	$LAT (DB) = EAT (DB) - \frac{SC}{CFM \times 1.08} \quad S/T = \frac{SC}{TC}$

Constant = 500 for water, 485 for antifreeze

Conversion Table - to convert inch-pound (English) to S-I (Metric)

Airflow	Water Flow	External Static Pressure	Water Pressure Drop
Airflow (L/s) = CFM x 0.472	Water Flow (L/s) = GPM x 0.0631	ESP (Pa) = ESP (in of wg) x 249	PD (kPa) = PD (ft of hd) x 2.99

Legend and Glossary of Abbreviations

Abbreviations	Descriptions
Btuh	Btu (British Thermal Unit) per hour
BMS	Building Management System
CDT	Compressor discharge temperature
CFM	Airflow, cubic feet per minute
COP	Coefficient of performance = Btuh output/Btuh input
CT EC	Electronically commutated constant torque blower motor
CV EC	Electronically commutated constant volume blower motor
DB	Dry bulb temperature, °F
DT	Delta T
EAT	Entering air temperature
EER	Energy efficient ratio = Btuh output/Watt input
ESP	External static pressure, inches w.g.
EWT	Entering water temperature
FPT	Female pipe thread
GPM	Water flow in U.S., gallons per minute
HC	Air heating capacity, Btuh
HE	Total heat of extraction, Btuh
HGRH	Hot Gas Reheat

Abbreviations	Descriptions
HR	Total heat of rejection, Btuh
HWG	Hot water generator (desuperheater) capacity, MBtuh
kW	Total power unit input, kilowatts
LAT	Leaving air temperature, °F
LC	Latent cooling capacity, Btuh
LOC	Loss of charge
LWT	Leaving water temperature, °F
MBtuh	1,000 Btu per hour
MPT	Male pipe thread
MWV	Motorized water valve
PSC	Permanent split capacitor
RDS	Refrigerant Detection System
SC	Sensible cooling capacity, Btuh
S/T	Sensible to total cooling ratio
TC	Total cooling capacity, Btuh
TD or delta T	Temperature differential
VFD	Variable frequency drive
WB	Wet bulb temperature, °F
WPD	Waterside pressure drop, psi or feet of head
WSE	Waterside economizer

USE THE FOLLOWING SELECTION STEPS

1. Determine the actual heating and cooling loads at the desired dry bulb and wet bulb conditions.
2. Obtain the following design parameters: Entering water temperature, water flow rate in GPM, airflow in CFM, water flow pressure drop and design wet and dry bulb temperatures. Airflow CFM should be between 300 and 450 CFM per ton. Unit water pressure drop should be kept as close as possible to each other to make water balancing easier. Go to the appropriate tables and find the proper indicated water flow and water temperature.
3. Select a unit based on total and sensible cooling conditions. Select a unit which is closest to, but no larger than, the actual cooling load.
4. Enter tables at the design water flow and water temperature. Read the total and sensible cooling capacities

Note: interpolation is permissible, extrapolation is not.

5. Read the heating capacity. If it exceeds the design criteria it is acceptable. It is quite normal for water-source heat pumps to be selected on cooling capacity only since the heating output is usually greater than the cooling capacity.
6. Determine the correction factors associated with the variable factors of dry bulb and wet bulb.

Corrected Total Cooling =
tabulated total cooling x wet bulb correction.

Corrected Sensible Cooling =
tabulated sensible cooling x wet/dry bulb correction.

7. Compare the corrected capacities to the load requirements. Normally if the capacities are within 10% of the loads, the equipment is acceptable. It is better to undersize than oversize, as undersizing improves humidity control, reduces sound levels and extends the life of the equipment.
8. When completed, calculate water temperature rise and assess the selection. If the units selected are not within 10% of the load calculations, then review what effect changing the GPM, water temperature and/or air flow and air temperature would have on the corrected capacities. If the desired capacity cannot be achieved, select the next larger or smaller unit and repeat the procedure. Remember, when in doubt, undersize slightly for best performance.

EXAMPLE EQUIPMENT SELECTION FOR COOLING

Step 1: Load Determination

Assume we have determined that the appropriate cooling load at the desired dry bulb 80°F and wet bulb 65°F conditions is as follows:

Total Cooling 22,000 Btuh
Sensible Cooling 18,200 Btuh
Entering Air Temp..... 80°F Dry Bulb / 65°F Wet Bulb

Step 2: Design Conditions

Similarly, we have also obtained the following design parameters:

Entering Water Temp 90°F
Water Flow (Based upon 10°F rise in temp) .4.5 GPM
Airflow 600 CFM

Steps 3, 4, and 5: HP Selection

After making our preliminary selection (SE024), we enter the tables at design water flow and water temperature and read Total Cooling, Sensible Cooling and Heat of Rejection capacities:

Total Cooling 22,500 Btuh
Sensible Cooling 16,500 Btuh
Heat of Rejection 28,800 Btuh

Steps 6 and 7: Entering Airflow Corrections

Next, we determine our correction factors.

Corrected Values	Table	Ent Air	Airflow	Corrected
Corrected Total Cooling	= 22,500 x	0.976 x	0.967 =	21,235
Corrected Sensible Cooling	= 16,500 x	0.919 x	1.089 =	16,513
Corrected Heat of Rejection	= 28,800 x	0.969 x	0.972 =	27,126

Step 8: Water Temperature Rise Calculation and Assessment

Actual Temperature Rise 12.1°F

When we compare the Corrected Total Cooling and Corrected Sensible Cooling figures with our load requirements stated in Step 1, we discover that our selection is within ±10% of our sensible load requirement. Furthermore, we see that our Corrected Total Cooling figure is within 1,000 Btuh the actual indicated load.

Model Nomenclature

1 | 2 | 3 | 4 | 5 | 6 | 7 | 8 | 9 | 10 | 11 | 12 | 13 | 14 | 15
| S | E | L | O | 2 | 4 | A | G | D | D | O | R | O | V | S |

MODEL

S = R-454B Refrigerant

MODEL TYPE

E = Premier Two-Stage Series

SUPPLY & RETURN CONFIGURATIONS

Horizontal Configuration		
	Left	Right
Straight	L	R
Back	B	P
Down Flow Configuration		
	Left	Right
Down	D	N
Vertical Configuration		
	Left	Right
Top	T	K

SIZE

024 060
 036 072
 048

REVISION

A = Current

VOLTAGE¹

G = 208/230-1-60
 J = 208/230-1-60 Refrigerant Detection System

CONTROLS

Control	Standard	Soft Start
DXM2.5	D	4
DXM2.5 with Disconnect	B	-

NOTES:

- SE sizes 060 and 072 require J voltage.
- All Open Loop vFlow Water Circuit Options require a Cupro-Nickel Heat Exchanger. All Closed Loop vFlow Water Circuit Options require a Standard Heat Exchanger. If no Water Circuit Option is selected, then the Heat Exchanger can be either Standard or Cupro-Nickel.
- Available with sizes 024 and 036.
- SE 024-048 offered with Microchannel Air Coil only.
SE 060-072 offered with Tin-Coated Air Coil only.

STANDARD

S = Standard

BLOWER MOTOR

V = Constant Volume (CV) EC

EXTENDED OPTIONS

O = Standard
 P = HWG and Pump

DRAIN PAN/HEAT EXCHANGER OPTIONS⁴

S = Stainless Steel Drain Pan, Aluminum Microchannel Air Coil
 R = Stainless Steel Drain Pan, Tin-Coated Air Coil

WATER/HEAT EXCHANGER OPTIONS²

Water Option	Standard	Cupro-Nickel
None	0	Z
MOD Valve, Low System Pressure Drop	C	-
MOD Valve, High System Pressure Drop	-	P
Internal Flow Controller Standard Head with Check Valve ³	1	-
Internal Flow Controller Standard Head w/o Check Valve ³	G	
Internal Flow Controller High Head with Check Valve	2	
Internal Flow Controller High Head w/o Check Valve	H	

CABINET

D = Residential

Performance Data: AHRI/ASHRAE/ISO 13256-1

Models:
SE
024-072

ASHRAE/AHRI/ISO 13256-1 English (I-P) Units

Model	Motor Type	WSHP (Part Load)											
		Water Loop Heat Pump				Ground Water Heat Pump				Ground Loop Heat Pump			
		Cooling 86°F		Heating 68°F		Cooling 59°F		Heating 50°F		Cooling 68°F		Heating 41°F	
		Capacity Btuh	EER Btuh/W	Capacity Btuh	COP	Capacity Btuh	EER Btuh/W	Capacity Btuh	COP	Capacity Btuh	EER Btuh/W	Capacity Btuh	COP
SE024	EC	17,900	19.2	20,100	6.6	20,200	36.2	17,100	5.7	19,400	27.9	18,900	4.4
SE036	EC	26,400	20.2	30,600	6.5	30,200	35.3	25,800	5.6	28,500	29.7	22,700	5.0
SE048	EC	35,700	19.6	42,900	6.5	41,000	41.8	33,700	5.3	37,400	28.6	29,000	4.7
SE060	EC	42,200	18.9	44,800	5.9	48,000	32.9	35,900	4.8	46,400	27.5	30,900	4.1
SE072	EC	53,500	17.9	59,200	5.4	61,400	34.8	48,000	4.5	58,000	24.1	42,400	4.1

Notes:

- Where dual voltages are available ratings are based on the lower voltage setting.
- Cooling capacities based upon 80.6°F DB, 66.2°F WB entering air temperature.
- Heating capacities based upon 68°F DB, 59°F WB entering air temperature.
- Ground Loop Heat Pump ratings based on 15% antifreeze solution.

ASHRAE/AHRI/ISO 13256-1 English (I-P) Units

Model	Motor Type	WSHP (Full Load)											
		Water Loop Heat Pump				Ground Water Heat Pump				Ground Loop Heat Pump			
		Cooling 86°F		Heating 68°F		Cooling 59°F		Heating 50°F		Full Cooling 77°F		Full Heating 32°F	
		Capacity Btuh	EER Btuh/W	Capacity Btuh	COP	Capacity Btuh	EER Btuh/W	Capacity Btuh	COP	Capacity Btuh	EER Btuh/W	Capacity Btuh	COP
SE024	EC	25,300	17.1	29,000	5.7	28,600	26.2	23,400	5.0	26,300	19.9	17,800	4.1
SE036	EC	37,500	17.0	43,100	5.4	41,000	24.4	35,700	4.9	39,000	18.8	28,400	4.2
SE048	EC	48,000	17.2	60,200	5.3	54,600	26.0	49,100	4.5	51,700	19.4	38,100	3.9
SE060	EC	61,800	16.9	67,300	5.3	66,800	24.7	55,700	4.7	62,600	18.7	44,300	3.9
SE072	EC	72,000	16.1	81,400	4.9	77,000	22.4	67,400	4.4	74,700	18.4	54,000	3.8

Notes:

- Where dual voltages are available ratings are based on the lower voltage setting.
- Cooling capacities based upon 80.6°F DB, 66.2°F WB entering air temperature.
- Heating capacities based upon 68°F DB, 59°F WB entering air temperature.
- Ground Loop Heat Pump ratings based on 15% antifreeze solution.

Performance Data: AHRI/ASHRAE/ISO 13256-1

Models:
SE
024-072

ASHRAE/AHRI/ISO 13256-1 Metric (S-I) Units

Model	Motor Type	WSHP (Part Load)											
		Water Loop Heat Pump				Ground Water Heat Pump				Ground Loop Heat Pump			
		Cooling 30°C		Heating 20°C		Cooling 15°C		Heating 10°C		Full Cooling 20°C		Full Heating 5°C	
		Capacity kW	EER W/W	Capacity kW	COP	Capacity kW	EER W/W	Capacity kW	COP	Capacity kW	EER W/W	Capacity kW	COP
SE024	EC	5	5.6	6	6.6	6	10.6	5	5.7	6	8.2	6	4.4
SE036	EC	8	5.9	9	6.5	9	10.4	8	5.6	8	8.7	7	5.0
SE048	EC	10	5.7	13	6.5	12	12.3	10	5.3	11	8.4	8	4.7
SE060	EC	12	5.5	13	5.9	14	9.6	11	4.8	14	8.1	9	4.1
SE072	EC	16	5.2	17	5.4	18	10.2	14	4.5	17	7.1	12	4.1

Notes:

- Where dual voltages are available ratings are based on the lower voltage setting.
- Cooling capacities based upon 20°C DB, 15°C WB entering air temperature.
- Heating capacities based upon 20°C DB, 15°C WB entering air temperature.
- Ground Loop Heat Pump ratings based on 15% antifreeze solution.

ASHRAE/AHRI/ISO 13256-1 Metric (S-I) Units

Model	Motor Type	WSHP (Full Load)											
		Water Loop Heat Pump				Ground Water Heat Pump				Ground Loop Heat Pump			
		Cooling 30°C		Heating 20°C		Cooling 15°C		Heating 10°C		Full Cooling 25°C		Full Heating 0°C	
		Capacity kW	EER W/W	Capacity kW	COP	Capacity kW	EER W/W	Capacity kW	COP	Capacity kW	EER W/W	Capacity kW	COP
SE024	EC	7	5.0	8	5.7	8	7.7	7	5.0	8	5.8	5	4.1
SE036	EC	11	5.0	13	5.4	12	7.2	10	4.9	11	5.5	8	4.2
SE048	EC	14	5.0	18	5.3	16	7.6	14	4.5	15	5.7	11	3.9
SE060	EC	18	5.0	20	5.3	20	7.2	16	4.7	18	5.5	13	3.9
SE072	EC	21	4.7	24	4.9	23	6.6	20	4.4	22	5.4	16	3.8

Notes:

- Where dual voltages are available ratings are based on the lower voltage setting.
- Cooling capacities based upon 27°C DB, 19°C WB entering air temperature.
- Heating capacities based upon 20°C DB, 15°C WB entering air temperature.
- Ground Loop Heat Pump ratings based on 15% antifreeze solution.

Performance Data: Selection Notes

Models:
SE
024-072

For operation in the shaded area when water is used instead of an antifreeze solution, the LWT (Leaving Water Temperature) must be calculated. Flow must be maintained to a level such that the LWT is maintained above 40°F (4.4°C) when the JW3 jumper is not clipped (see example below). Otherwise, appropriate levels of a proper antifreeze solution should be used in systems with leaving water temperatures of 40°F (4.4°C) or below and the JW3 jumper should be clipped. This is due to the potential of the refrigerant temperature being as low as 32°F (0°C) with 40°F (4.4°C) LWT, which may lead to a nuisance cutout due to the activation of the Low Temperature Protection. JW3 should never be clipped for standard-range equipment or systems without antifreeze.

Example:

At 50°F EWT (Entering Water Temperature) and 1.5 GPM/ton, a 3-ton unit has a HE of 22,500 Btuh. To calculate LWT, rearrange the formula for HE as follows:

$HE = TD \times GPM \times 500$, where HE = Heat of Extraction (Btuh); TD = temperature difference (EWT - LWT) and GPM = U.S. Gallons per Minute.

$$TD = HE / (GPM \times 500)$$

$$TD = 22,500 / (1.5 \times 500)$$

$$TD = 10^\circ F$$

$$LWT = EWT - TD$$

$$LWT = 50 - 10 = 40^\circ F$$

In this example, as long as the EWT does not fall below 50°F, the system will operate as designed. For EWTs below 50°F, higher flow rates will be required (open loop systems, for example, require at least 2 GPM/ton when EWT is below 50°F).

		Heating - EAT 70°F					
		EER	HC	Power kW	HE	LAT	COP
Not Recommended							
			4.0	0.45	2.5	84.6	2.6
8.6	27.4	4.6	0.46	3.0	86.8	2.9	
8.6	31.0	4.8	0.47	3.2	87.8	3.0	
8.6	33.0	4.9	0.47	3.3	88.3	3.1	
8.4	23.3	5.4	0.48	3.8	90.2	3.3	
8.5	26.3	5.7	0.49	4.0	91.4	3.4	
8.6	27.9	5.9	0.49	4.2	92.1	3.5	
8.2	19.8	6.2	0.50	4.5	93.6	3.7	
4	22.3	6.6	0.50	4.9	95.0	3.8	
	23.7	6.8	0.51	5.0	95.8	3.9	
	16.7	7.0	0.51	5.3	96.9	4.0	
	8.8	7.4	0.52	5.6	98.5	4.1	
		7.6	0.52	5.8	99.3	4.2	
			0.53	6.0	100.0	4.3	

ClimateMaster works continually to improve its products. As a result, the design and specifications of each product at the time of order may be changed without notice and may not be as described herein. Please contact ClimateMaster's Customer Service Department at 800-299-9747 for specific information on the current design and specifications. Statements and other information contained herein are not express warranties and do not form the basis of any bargain between the parties, but are merely ClimateMaster's opinion or commendation of its products. The latest version of this document is available at www.climatemaster.com. Engineered and assembled in the USA. © ClimateMaster, Inc. All Rights Reserved 2024

Performance Data SE*024 EC Blower Motor (Part Load)

Models:
SE
024-072

700 CFM Rated Airflow

EWT °F	WPD			COOLING - EAT 80/67 °F							WPD			HEATING - EAT 70°F															
	FLOW GPM	PSI	FT	TC	SC	EC					FLOW GPM	PSI	FT	HC	EC														
						kW	HR	EER	LWT	HWG Cap					kW	HE	COP	LWT	HWG Cap										
20	Operation Not Recommended										4.70	0.7	1.5	10.7	1.09	7.0	2.9	17.0	1.2										
30	1.60	0.1	0.2	22.0	15.3	0.60	24.0	36.8	60.0	0.2	2.35	0.1	0.3	12.3	1.09	8.5	3.3	22.7	1.3										
											3.53	0.2	0.5	12.8	1.09	9.1	3.4	24.8	1.4										
											4.70	0.5	1.2	13.1	1.09	9.4	3.5	26.0	1.4										
40	2.34	0.1	0.2	21.3	14.7	0.63	23.4	34.1	60.0	0.2	2.35	0.1	0.3	14.4	1.09	10.7	3.9	30.9	1.4										
											3.53	0.2	0.4	15.1	1.09	11.4	4.1	33.5	1.4										
											4.70	0.4	1.0	15.5	1.09	11.8	4.2	35.0	1.5										
50	2.35	0.1	0.3	21.2	15.1	0.73	23.7	29.0	70.2	0.7	2.35	0.1	0.3	16.5	1.09	12.8	4.5	39.1	1.5										
											3.53	0.2	0.3	17.3	1.09	13.6	4.7	42.3	1.6										
											4.70	0.4	0.9	17.8	1.09	14.1	4.8	44.0	1.6										
60	2.35	0.1	0.3	20.7	15.1	0.86	23.6	24.1	80.1	1.1	2.35	0.1	0.3	18.6	1.09	14.9	5.0	47.3	1.7										
											3.53	0.1	0.3	19.5	1.09	15.8	5.3	51.0	1.7										
											4.70	0.3	0.8	20.0	1.09	16.3	5.4	53.1	1.8										
70	2.35	0.1	0.3	19.8	14.8	1.00	23.2	19.8	89.7	1.6	2.35	0.1	0.3	20.6	1.09	16.9	5.6	55.6	1.8										
											3.53	0.1	0.3	21.6	1.09	17.9	5.8	59.8	1.9										
											4.70	0.3	0.7	22.2	1.09	18.5	6.0	62.1	1.9										
80	2.35	0.1	0.3	18.6	14.4	1.16	22.6	16.1	99.2	2.2	2.35	0.1	0.3	22.6	1.09	18.9	6.1	63.9	2.0										
											3.53	0.1	0.3	23.7	1.09	20.0	6.4	68.7	2.1										
											4.70	0.3	0.7	24.3	1.09	20.5	6.5	71.3	2.1										
85	2.35	0.1	0.3	18.0	14.1	1.24	22.2	14.5	103.9	2.4	2.35	0.1	0.3	23.6	1.09	19.8	6.3	68.1	2.1										
											3.53	0.1	0.3	24.7	1.09	21.0	6.6	73.1	2.1										
											4.70	0.3	0.6	25.3	1.09	21.6	6.8	75.8	2.2										
90	2.35	0.1	0.3	17.2	13.8	1.33	21.8	13.0	108.5	2.9	2.03	0.1	0.2	24.0	1.09	20.3	6.5	70.0	2.2										
																				3.53	0.1	0.3	18.1	14.2	1.22	22.3	14.9	102.6	2.8
																				4.70	0.3	0.6	18.6	14.3	1.16	22.5	16.0	99.6	2.7
100	2.35	0.1	0.3	15.7	13.2	1.51	20.9	10.4	117.8	3.7	1.35	0.10	0.2	24.0	1.09	20.3	6.5	70.0	2.2										
																				3.53	0.1	0.3	16.7	13.6	1.40	21.4	12.0	112.2	3.6
																				4.70	0.2	0.5	17.1	13.8	1.34	21.7	12.8	109.2	3.5
110	2.35	0.1	0.3	14.2	12.6	1.70	20.0	8.3	127.0	4.6	1.01	0.10	0.2	24.0	1.09	20.3	6.5	70.0	2.2										
																				3.53	0.1	0.3	15.1	12.9	1.59	20.5	9.5	121.6	4.4
																				4.70	0.2	0.4	15.6	13.1	1.53	20.8	10.2	118.8	4.3
120	2.35	0.1	0.3	12.6	11.9	1.91	19.1	6.6	136.2	5.6	0.81	0.10	0.2	24.0	1.09	20.3	6.5	70.0	2.2										
																				3.53	0.1	0.3	13.4	12.3	1.79	19.6	7.5	131.1	5.4
																				4.70	0.1	0.3	13.9	12.5	1.73	19.8	8.0	128.4	5.3

- Interpolation is permissible; extrapolation is not.
- All entering air conditions are 80°F (26.6°C) DB and 67°F (19.4°C) WB in cooling, and 70°F (21°C) DB in heating.
- AHRI/ISO certified conditions are 80.6°F (27°C) DB and 66.2°F (19°C) WB in cooling and 68°F (20°C) DB in heating.
- Table does not reflect fan or pump power corrections for AHRI/ISO conditions.
- All performance is based upon the lower voltage of dual voltage rated units.
- Performance stated is at the rated power supply; performance may vary as the power supply varies from the rated.
- Operation below 40°F (10.0°C) EWT is based upon 20% methanol antifreeze solution.
- Operation below 60°F (15.5°C) EWT requires optional insulated water/refrigerant circuit.
- See performance correction tables for operating conditions other than those listed above.
- See Performance Data Selection Notes for operation in the shaded areas.
- Regular Cooling operation with an EWT of less than 50°F (10.0°C) is not recommended unless variable water flow is available.
- Regular Heating operation with an EWT of more than 90°F (32°C) is not recommended unless variable water flow is available.
- For quiet operation and long term reliability, it is recommended that systems be designed to avoid continuous operation in the outlined areas.
- Performance capacities shown in thousands of Btuh
- Hot Water Generator Capacity is based on 90°F entering water and 0.5 GPM/Ton.

ClimateMaster works continually to improve its products. As a result, the design and specifications of each product at the time of order may be changed without notice and may not be as described herein. Please contact ClimateMaster's Customer Service Department at 800-299-9747 for specific information on the current design and specifications. Statements and other information contained herein are not express warranties and do not form the basis of any bargain between the parties, but are merely ClimateMaster's opinion or commendation of its products. The latest version of this document is available at www.climatemaster.com. Engineered and assembled in the USA. © ClimateMaster, Inc. All Rights Reserved 2024

Performance Data SE*024 EC Blower Motor (Full Load)

Models:
SE
024-072

800 CFM Rated Airflow

EWT °F	WPD			COOLING - EAT 80/67 °F							WPD			HEATING - EAT 70°F															
	FLOW GPM	PSI	FT	TC	SC	EC					FLOW GPM	PSI	FT	HC	EC														
						kW	HR	EER	LWT	HWG Cap					kW	HE	COP	LWT	HWG Cap										
20	Operation Not Recommended										6.00	1.2	2.7	16.2	1.47	11.1	3.2	16.3	1.9										
30	2.14	0.10	0.20	28.5	19.1	1.06	32.1	27.0	60.0	1.4	3.00	0.1	0.3	17.9	1.49	12.8	3.5	21.5	2.0										
											4.50	0.5	1.2	18.7	1.50	13.6	3.7	24.0	2.2										
40	3.15	0.10	0.30	27.8	18.5	1.07	31.5	26.0	60.0	1.4	6.00	1.0	2.3	19.2	1.50	14.0	3.7	25.3	2.5										
											3.00	0.1	0.3	20.6	1.52	15.4	4.0	29.7	2.2										
											4.50	0.4	1.0	21.6	1.53	16.3	4.1	32.7	2.5										
50	3.00	0.1	0.3	27.8	18.9	1.21	32.0	23.0	71.3	1.7	6.00	0.9	2.1	22.1	1.53	16.8	4.2	34.4	2.7										
											3.00	0.1	0.3	23.2	1.55	18.0	4.4	38.0	2.5										
											4.50	0.4	0.8	24.3	1.56	19.0	4.6	41.6	2.7										
60	3.00	0.1	0.3	27.9	18.7	1.12	31.7	25.0	64.1	1.6	6.00	0.8	1.9	24.9	1.57	19.6	4.6	43.5	3.0										
											3.00	0.1	0.3	27.3	18.8	1.35	31.9	20.2	81.3	2.1	3.00	0.1	0.3	25.8	1.59	20.4	4.8	46.4	2.8
											4.50	0.3	0.7	27.7	18.9	1.25	32.0	22.2	74.2	1.9	4.50	0.3	0.7	27.1	1.61	21.6	4.9	50.4	3.1
70	3.00	0.1	0.3	27.9	18.9	1.07	31.9	23.2	70.6	1.8	6.00	0.8	1.7	27.8	1.62	22.2	5.0	52.6	3.3										
											3.00	0.1	0.3	26.3	18.4	1.51	31.5	17.4	91.0	2.7	3.00	0.1	0.3	28.4	1.63	22.9	5.1	54.8	3.1
											4.50	0.3	0.6	27.0	18.7	1.40	31.8	19.4	84.1	2.4	4.50	0.3	0.6	29.8	1.65	24.2	5.3	59.3	3.5
80	3.00	0.1	0.3	27.3	18.8	1.34	31.9	20.4	80.6	2.2	6.00	0.7	1.6	30.6	1.67	24.9	5.4	61.7	3.8										
											3.00	0.1	0.3	25.1	17.9	1.70	30.9	14.8	100.6	3.4	3.00	0.1	0.3	31.0	1.68	25.3	5.4	63.2	3.5
											4.50	0.2	0.5	26.0	18.3	1.57	31.4	16.6	93.9	3.1	4.50	0.2	0.5	32.5	1.71	26.7	5.6	68.1	3.9
85	3.00	0.1	0.3	26.4	18.5	1.51	31.5	17.5	90.5	2.8	6.00	0.7	1.6	33.4	1.73	27.5	5.7	70.8	4.3										
											3.00	0.1	0.3	24.4	17.6	1.80	30.6	13.6	105.4	3.5	3.00	0.1	0.3	32.3	1.70	26.5	5.6	67.4	3.7
											4.50	0.2	0.5	25.4	18.0	1.66	31.0	15.3	98.8	3.3	4.50	0.2	0.5	33.9	1.74	28.0	5.7	72.6	4.1
90	3.00	0.1	0.3	25.8	18.2	1.60	31.3	16.2	95.4	3.2	6.00	0.7	1.5	34.8	1.76	28.8	5.8	75.4	4.4										
											3.00	0.1	0.3	23.7	17.2	1.91	30.2	12.4	110.1	4.4	2.72	0.1	0.2	33.1	1.72	27.2	5.6	70.0	4.4
											4.50	0.2	0.5	24.7	17.7	1.76	30.7	14.0	103.6	4.0									
100	3.00	0.1	0.3	25.2	17.9	1.69	30.9	14.9	100.3	3.6	1.82	0.1	0.2	33.1	1.72	27.2	5.6	70.0	4.4										
											3.00	0.1	0.3	22.1	16.6	2.15	29.5	10.3	119.6	5.4									
											4.50	0.2	0.4	23.2	17.0	1.99	30.0	11.7	113.3	5.0									
110	3.00	0.1	0.3	23.7	17.2	1.91	30.2	12.4	110.1	4.1	1.36	0.1	0.2	33.1	1.72	27.2	5.6	70.0	4.4										
											3.00	0.1	0.3	20.5	15.9	2.43	28.8	8.4	129.2	6.7									
											4.50	0.2	0.4	21.6	16.3	2.25	29.2	9.6	123.0	6.2									
120	3.00	0.1	0.3	22.1	16.6	2.16	29.5	10.2	119.8	5.1	1.09	0.1	0.2	33.1	1.72	27.2	5.6	70.0	4.4										
											3.00	0.1	0.3	18.9	15.4	2.75	28.3	6.9	138.8	8.2									
											4.50	0.1	0.3	19.9	15.7	2.54	28.6	7.8	132.7	7.5									

- Interpolation is permissible; extrapolation is not.
- All entering air conditions are 80°F (26.6°C) DB and 67°F (19.4°C) WB in cooling, and 70°F (21°C) DB in heating.
- AHRI/ISO certified conditions are 80.6°F (27°C) DB and 66.2°F (19°C) WB in cooling and 68°F (20°C) DB in heating.
- Table does not reflect fan or pump power corrections for AHRI/ISO conditions.
- All performance is based upon the lower voltage of dual voltage rated units.
- Performance stated is at the rated power supply; performance may vary as the power supply varies from the rated.
- Operation below 40°F (10.0°C) EWT is based upon 20% methanol antifreeze solution.
- Operation below 60°F (15.5°C) EWT requires optional insulated water/refrigerant circuit.
- See performance correction tables for operating conditions other than those listed above.
- See Performance Data Selection Notes for operation in the shaded areas.
- Regular Cooling operation with an EWT of less than 50°F (10.0°C) is not recommended unless variable water flow is available.
- Regular Heating operation with an EWT of more than 90°F (32°C) is not recommended unless variable water flow is available.
- For quiet operation and long term reliability, it is recommended that systems be designed to avoid continuous operation in the outlined areas.
- Performance capacities shown in thousands of Btuh
- Hot Water Generator Capacity is based on 90°F entering water and 0.5 GPM/Ton.

ClimateMaster works continually to improve its products. As a result, the design and specifications of each product at the time of order may be changed without notice and may not be as described herein. Please contact ClimateMaster's Customer Service Department at 800-299-9747 for specific information on the current design and specifications. Statements and other information contained herein are not express warranties and do not form the basis of any bargain between the parties, but are merely ClimateMaster's opinion or commendation of its products. The latest version of this document is available at www.climatemaster.com. Engineered and assembled in the USA. © ClimateMaster, Inc. All Rights Reserved 2024

Performance Data SE*036 EC Blower Motor (Part Load)

Models:
SE
024-072

1100 CFM Rated Airflow

EWT °F	WPD			COOLING - EAT 80/67 °F							WPD			HEATING - EAT 70°F															
	FLOW GPM	PSI	FT	TC	SC	EC					FLOW GPM	PSI	FT	HC	EC														
						kW	HR	EER	LWT	HWG Cap					kW	HE	COP	LWT	HWG Cap										
20	Operation Not Recommended										6.70	2.2	5.0	16.7	1.47	11.7	3.3	16.5	1.6										
30	2.42	0.2	0.4	33.4	21.9	0.87	36.3	38.3	60.0	1.1	3.35	0.6	1.4	18.9	1.49	13.8	3.7	21.7	1.7										
											5.03	1.2	2.7	19.9	1.50	14.8	3.9	24.1	1.7										
											6.70	2.0	4.5	20.4	1.50	15.3	4.0	25.4	1.8										
40	3.49	0.6	1.3	31.8	20.8	0.91	34.9	35.0	60.0	1.1	3.35	0.5	1.2	22.1	1.52	17.0	4.3	29.9	1.8										
											5.03	1.1	2.5	23.3	1.52	18.1	4.5	32.8	1.8										
											6.70	1.8	4.1	23.9	1.53	18.7	4.6	34.4	1.9										
50	3.35	0.5	1.1	31.8	21.4	1.05	35.4	30.3	71.2	1.3	3.35	0.5	1.1	25.2	1.54	20.0	4.8	38.1	1.9										
											5.03	1.0	2.3	26.5	1.55	21.2	5.0	41.6	1.9										
											6.70	1.6	3.8	31.8	20.9	0.91	34.9	34.9	60.4	1.2	6.70	1.6	3.8	27.2	1.56	21.9	5.1	43.5	2.0
60	3.35	0.5	1.1	30.9	21.3	1.21	35.1	25.6	80.9	1.4	3.35	0.5	1.1	28.2	1.57	22.9	5.3	46.3	2.0										
											5.03	0.9	2.1	31.7	21.5	1.09	35.4	28.9	74.1	1.4	5.03	0.9	2.1	29.6	1.58	24.3	5.5	50.4	2.1
											6.70	1.5	3.6	31.9	21.4	1.04	35.4	30.6	70.6	1.3	6.70	1.5	3.6	30.4	1.59	25.0	5.6	52.5	2.2
70	3.35	0.5	1.0	29.5	20.8	1.38	34.2	21.3	90.4	1.8	3.35	0.5	1.0	31.1	1.59	25.7	5.7	54.6	2.3										
											5.03	0.9	2.1	30.5	21.2	1.26	34.8	24.3	83.9	1.7	5.03	0.9	2.1	32.7	1.61	27.2	6.0	59.2	2.3
											6.70	1.5	3.4	31.0	21.3	1.20	35.1	25.9	80.5	1.7	6.70	1.5	3.4	33.6	1.61	28.1	6.1	61.6	2.4
80	3.35	0.4	1.0	27.7	20.1	1.58	33.1	17.5	99.8	2.4	3.35	0.4	1.0	34.0	1.62	28.5	6.2	63.0	2.5										
											5.03	0.9	2.0	28.9	20.6	1.45	33.9	20.0	93.5	2.3	5.03	0.9	2.0	35.7	1.63	30.2	6.4	68.0	2.6
											6.70	1.4	3.3	29.5	20.8	1.38	34.2	21.4	90.2	2.3	6.70	1.4	3.3	36.7	1.64	31.1	6.5	70.7	2.7
85	3.35	0.4	1.0	26.8	19.7	1.69	32.5	15.9	104.4	2.9	3.35	0.4	1.0	35.5	1.63	29.9	6.4	67.2	2.6										
											5.03	0.9	2.0	28.0	20.2	1.55	33.3	18.1	98.2	2.8	5.03	0.9	2.0	37.3	1.65	31.6	6.6	72.4	2.7
											6.70	1.4	3.3	28.6	20.5	1.48	33.7	19.4	95.1	2.6	6.70	1.4	3.3	38.2	1.66	32.6	6.8	75.3	2.8
90	3.35	0.4	1.0	25.8	19.2	1.80	31.9	14.4	109.1	3.3	3.1	0.1	0.2	36.4	1.64	30.8	6.5	70.0	2.8										
																				5.03	0.9	2.0	27.0	19.8	1.65	32.7	16.4	103.0	3.2
																				6.70	1.4	3.2	27.7	20.1	1.58	33.1	17.5	99.9	3.1
100	3.35	0.4	1.0	24.0	18.5	2.04	30.9	11.8	118.5	4.4	2.1	0.1	0.2	36.4	1.6	30.8	6.5	70.0	2.8										
																				5.03	0.8	1.9	25.1	19.0	1.88	31.5	13.3	112.5	4.3
																				6.70	1.4	3.2	25.7	19.2	1.81	31.9	14.2	109.5	4.1
110	3.35	0.4	1.0	22.4	18.0	2.30	30.3	9.7	128.1	5.7	1.5	0.1	0.2	36.4	1.6	30.8	6.5	70.0	2.8										
																				5.03	0.8	1.9	23.3	18.3	2.14	30.6	10.9	122.2	5.6
																				6.70	1.3	3.1	23.8	18.5	2.06	30.9	11.6	119.2	5.4
120	3.35	0.4	1.0	21.4	18.1	2.60	30.3	8.2	138.1	7.3	1.2	0.1	0.2	36.4	1.6	30.8	6.5	70.0	2.8										
																				5.03	0.8	1.8	22.0	18.0	2.42	30.2	9.1	132.0	7.1
																				6.70	1.3	3.0	22.3	18.0	2.33	30.3	9.6	129.0	6.9

- Interpolation is permissible; extrapolation is not.
- All entering air conditions are 80°F (26.6°C) DB and 67°F (19.4°C) WB in cooling, and 70°F (21°C) DB in heating.
- AHRI/ISO certified conditions are 80.6°F (27°C) DB and 66.2°F (19°C) WB in cooling and 68°F (20°C) DB in heating.
- Table does not reflect fan or pump power corrections for AHRI/ISO conditions.
- All performance is based upon the lower voltage of dual voltage rated units.
- Performance stated is at the rated power supply; performance may vary as the power supply varies from the rated.
- Operation below 40°F (10.0°C) EWT is based upon 20% methanol antifreeze solution.
- Operation below 60°F (15.5°C) EWT requires optional insulated water/refrigerant circuit.
- See performance correction tables for operating conditions other than those listed above.
- See Performance Data Selection Notes for operation in the shaded areas.
- Regular Cooling operation with an EWT of less than 50°F (10.0°C) is not recommended unless variable water flow is available.
- Regular Heating operation with an EWT of more than 90°F (32°C) is not recommended unless variable water flow is available.
- For quiet operation and long term reliability, it is recommended that systems be designed to avoid continuous operation in the outlined areas.
- Performance capacities shown in thousands of Btuh
- Hot Water Generator Capacity is based on 90°F entering water and 0.5 GPM/Ton.

ClimateMaster works continually to improve its products. As a result, the design and specifications of each product at the time of order may be changed without notice and may not be as described herein. Please contact ClimateMaster's Customer Service Department at 800-299-9747 for specific information on the current design and specifications. Statements and other information contained herein are not express warranties and do not form the basis of any bargain between the parties, but are merely ClimateMaster's opinion or commendation of its products. The latest version of this document is available at www.climatemaster.com. Engineered and assembled in the USA. © ClimateMaster, Inc. All Rights Reserved 2024

Performance Data SE*036 EC Blower Motor (Full Load)

Models:
SE
024-072

1200 CFM Rated Airflow

EWT °F	WPD			COOLING - EAT 80/67 °F							WPD			HEATING - EAT 70°F					
	FLOW GPM	PSI	FT	TC	SC	EC					FLOW GPM	PSI	FT	HC	EC				
						kW	HR	EER	LWT	HWG Cap					kW	HE	COP	LWT	HWG Cap
20	Operation Not Recommended										9.00	3.7	8.5	23.9	1.95	17.3	3.6	16.2	2.0
30	3.30	0.4	0.9	44.2	27.8	1.55	49.5	28.5	60.0	1.1	4.50	1.0	2.3	26.7	2.00	19.9	3.9	21.2	2.5
											6.75	2.0	4.7	28.1	2.02	21.2	4.1	23.7	2.7
											9.00	3.2	7.5	28.8	2.04	21.9	4.1	25.1	3.0
40	4.74	1.0	2.2	42.1	26.5	1.56	47.4	27.0	60.0	1.1	4.50	0.9	2.1	31.1	2.08	24.0	4.4	29.4	3.0
											6.75	1.8	4.2	32.7	2.11	25.5	4.5	32.5	3.3
											9.00	2.9	6.8	33.5	2.13	26.3	4.6	34.2	3.6
50	4.50	0.8	1.9	42.5	27.3	1.75	48.5	24.4	71.6	1.6	4.50	0.8	1.9	35.3	2.17	27.9	4.8	37.6	3.5
											6.75	1.6	3.8	42.5	2.21	29.6	4.9	41.2	3.8
											9.00	2.7	6.2	42.2	2.24	30.5	5.0	43.2	4.2
60	4.50	0.8	1.8	41.6	27.2	1.93	48.2	21.6	81.4	2.2	4.50	0.8	1.8	39.4	2.27	31.7	5.1	45.9	4.0
											6.75	1.5	3.5	42.4	2.32	33.5	5.2	50.1	4.4
											9.00	2.5	5.9	42.6	2.35	34.5	5.3	52.3	4.8
70	4.50	0.7	1.7	39.9	26.5	2.12	47.1	18.8	90.9	3.0	4.50	0.7	1.7	43.5	2.37	35.4	5.4	54.3	4.5
											6.75	1.5	3.4	41.2	2.43	37.4	5.5	58.9	5.0
											9.00	2.4	5.6	41.7	2.47	38.4	5.6	61.5	5.4
80	4.50	0.7	1.7	37.7	25.5	2.34	45.7	16.1	100.3	3.9	4.50	0.7	1.7	47.4	2.48	38.9	5.6	62.7	5.0
											6.75	1.4	3.3	39.2	2.56	41.1	5.7	67.8	5.5
											9.00	2.4	5.5	40.0	2.60	42.2	5.8	70.6	6.0
85	4.50	0.7	1.7	36.5	24.9	2.46	44.9	14.9	105.0	4.4	4.50	0.7	1.7	49.4	2.54	40.7	5.7	66.9	5.3
											6.75	1.4	3.3	38.1	2.62	42.9	5.8	72.3	5.8
											9.00	2.4	5.4	38.9	2.66	44.1	5.9	75.2	6.3
90	4.50	0.7	1.7	35.4	24.3	2.59	44.2	13.7	109.6	5.1	4.20	0.1	0.2	50.8	2.59	42.0	5.8	70.0	6.3
											6.75	1.4	3.3	36.9	2.59	42.0	5.8	70.0	6.3
											9.00	2.3	5.4	37.8	2.59	42.0	5.8	70.0	6.3
100	4.50	0.7	1.6	33.1	23.2	2.87	42.9	11.5	119.1	6.4	2.80	0.1	0.2	50.8	2.59	42.0	5.8	70.0	6.3
											6.75	1.4	3.2	34.5	2.59	42.0	5.8	70.0	6.3
											9.00	2.3	5.3	35.3	2.59	42.0	5.8	70.0	6.3
110	4.50	0.7	1.6	31.2	22.3	3.19	42.0	9.8	128.7	7.9	2.10	0.1	0.2	50.8	2.59	42.0	5.8	70.0	6.3
											6.75	1.4	3.2	32.3	2.59	42.0	5.8	70.0	6.3
											9.00	2.2	5.1	33.0	2.59	42.0	5.8	70.0	6.3
120	4.50	0.7	1.5	29.9	22.0	3.57	42.1	8.4	138.7	9.7	1.68	0.1	0.2	50.8	2.59	42.0	5.8	70.0	6.3
											6.75	1.3	3.0	30.6	2.59	42.0	5.8	70.0	6.3
											9.00	2.1	4.9	31.1	2.59	42.0	5.8	70.0	6.3

- Interpolation is permissible; extrapolation is not.
- All entering air conditions are 80°F (26.6°C) DB and 67°F (19.4°C) WB in cooling, and 70°F (21°C) DB in heating.
- AHRI/ISO certified conditions are 80.6°F (27°C) DB and 66.2°F (19°C) WB in cooling and 68°F (20°C) DB in heating.
- Table does not reflect fan or pump power corrections for AHRI/ISO conditions.
- All performance is based upon the lower voltage of dual voltage rated units.
- Performance stated is at the rated power supply; performance may vary as the power supply varies from the rated.
- Operation below 40°F (10.0°C) EWT is based upon 20% methanol antifreeze solution.
- Operation below 60°F (15.5°C) EWT requires optional insulated water/refrigerant circuit.
- See performance correction tables for operating conditions other than those listed above.
- See Performance Data Selection Notes for operation in the shaded areas.
- Regular Cooling operation with an EWT of less than 50°F (10.0°C) is not recommended unless variable water flow is available.
- Regular Heating operation with an EWT of more than 90°F (32°C) is not recommended unless variable water flow is available.
- For quiet operation and long term reliability, it is recommended that systems be designed to avoid continuous operation in the outlined areas.
- Performance capacities shown in thousands of Btuh
- Hot Water Generator Capacity is based on 90°F entering water and 0.5 GPM/Ton.

ClimateMaster works continually to improve its products. As a result, the design and specifications of each product at the time of order may be changed without notice and may not be as described herein. Please contact ClimateMaster's Customer Service Department at 800-299-9747 for specific information on the current design and specifications. Statements and other information contained herein are not express warranties and do not form the basis of any bargain between the parties, but are merely ClimateMaster's opinion or commendation of its products. The latest version of this document is available at www.climatemaster.com. Engineered and assembled in the USA. © ClimateMaster, Inc. All Rights Reserved 2024

Performance Data SE*048 EC Blower Motor (Part Load)

Models:
SE
024-072

1500 CFM Rated Airflow

EWT °F	WPD			COOLING - EAT 80/67 °F							WPD			HEATING - EAT 70°F															
	FLOW GPM	PSI	FT	TC	SC	EC					FLOW GPM	PSI	FT	HC	EC														
						kW	HR	EER	LWT	HWG Cap					kW	HE	COP	LWT	HWG Cap										
20	Operation Not Recommended										9.20	2.1	4.9	23.1	2.16	15.7	3.1	16.6	2.4										
30	3.16	0.3	0.6	43.2	30.4	1.22	47.4	35.5	60.0	1.3	4.60	0.7	1.6	25.4	2.15	18.1	3.5	22.1	2.6										
											6.90	1.3	2.9	26.4	2.15	19.1	3.6	24.5	2.7										
											9.20	2.0	4.6	27.0	2.15	19.6	3.7	25.7	2.8										
40	4.59	0.6	1.4	41.6	29.0	1.27	45.9	32.8	60.0	1.3	4.60	0.6	1.5	29.2	2.15	21.9	4.0	30.5	2.9										
											6.90	1.2	2.7	30.6	2.16	23.2	4.1	33.3	3.0										
											9.20	1.9	4.3	31.3	2.16	23.9	4.2	34.8	3.0										
50	4.60	0.6	1.4	41.5	29.8	1.46	46.4	28.5	70.2	1.5	4.60	0.6	1.4	33.3	2.17	25.9	4.5	38.8	3.1										
											6.90	1.1	2.6	41.6	29.3	1.33	46.2	31.4	63.4	1.5	6.90	1.1	2.6	34.9	2.17	27.5	4.7	42.0	3.2
											9.20	1.8	4.1	41.5	28.9	1.27	45.8	32.8	60.0	1.4	9.20	1.8	4.1	35.9	2.18	28.4	4.8	43.8	3.3
60	4.60	0.6	1.4	40.4	29.8	1.68	46.1	24.0	80.0	2.0	4.60	0.6	1.4	37.5	2.19	30.0	5.0	46.9	3.4										
											6.90	1.1	2.5	41.2	29.9	1.53	46.4	27.0	73.5	1.9	6.90	1.1	2.5	39.5	2.20	32.0	5.3	50.7	3.5
											9.20	1.7	3.9	41.5	29.8	1.46	46.4	28.5	70.1	1.8	9.20	1.7	3.9	40.6	2.20	33.0	5.4	52.8	3.7
70	4.60	0.6	1.3	38.5	29.0	1.93	45.1	20.0	89.6	2.5	4.60	0.6	1.3	41.8	2.21	34.2	5.5	55.1	3.8										
											6.90	1.1	2.4	39.8	29.6	1.76	45.8	22.6	83.3	2.5	6.90	1.1	2.4	44.0	2.22	36.5	5.8	59.4	3.9
											9.20	1.7	3.9	40.4	29.8	1.68	46.1	24.0	80.0	2.4	9.20	1.7	3.9	45.3	2.22	37.7	6.0	61.8	4.0
80	4.60	0.6	1.3	36.1	27.8	2.20	43.6	16.4	99.0	3.3	4.60	0.6	1.3	46.0	2.23	38.4	6.1	63.3	4.2										
											6.90	1.0	2.4	37.7	28.6	2.02	44.6	18.6	92.9	3.2	6.90	1.0	2.4	48.5	2.24	40.9	6.4	68.2	4.3
											9.20	1.7	3.8	38.5	29.0	1.93	45.1	19.9	89.8	3.1	9.20	1.7	3.8	49.9	2.24	42.2	6.5	70.8	4.4
85	4.60	0.6	1.3	34.8	27.2	2.35	42.8	14.8	103.6	4.0	4.60	0.6	1.3	48.1	2.24	40.5	6.3	67.4	4.3										
											6.90	1.0	2.4	36.5	28.0	2.16	43.8	16.8	97.7	3.8	6.90	1.0	2.4	50.7	2.25	43.0	6.6	72.5	4.4
											9.20	1.6	3.8	37.3	28.4	2.07	44.3	18.0	94.6	3.5	9.20	1.6	3.8	52.1	2.25	44.4	6.8	75.3	4.6
90	4.60	0.6	1.3	33.3	26.4	2.50	41.9	13.3	108.2	4.2	4.18	0.1	0.2	49.5	2.24	41.8	6.5	70.0	4.6										
																				6.90	1.0	2.4	35.1	27.3	2.31	43.0	15.2	102.5	4.1
																				9.20	1.6	3.8	36.0	27.8	2.22	43.5	16.2	99.5	4.0
100	4.60	0.6	1.4	30.4	25.0	2.82	40.0	10.8	117.4	5.3	2.79	0.10	0.23	49.5	2.24	41.8	6.47	70.0	4.6										
																				6.90	1.0	2.4	32.2	25.8	2.63	41.1	12.2	111.9	5.2
																				9.20	1.6	3.7	33.1	26.3	2.53	41.7	13.1	109.1	5.0
110	4.60	0.6	1.3	27.3	23.5	3.16	38.1	8.6	126.6	6.6	2.09	0.10	0.23	49.5	2.24	41.8	6.47	70.0	4.6										
																				6.90	1.0	2.4	29.0	24.3	2.97	39.2	9.8	121.3	6.4
																				9.20	1.6	3.7	29.9	24.8	2.87	39.7	10.4	118.6	6.2
120	4.60	0.6	1.3	24.3	22.2	3.53	36.3	6.9	135.8	8.0	1.67	0.10	0.23	49.5	2.24	41.8	6.47	70.0	4.6										
																				6.90	1.0	2.3	25.9	22.9	3.33	37.3	7.8	130.8	7.8
																				9.20	1.6	3.6	26.7	23.3	3.23	37.8	8.3	128.2	7.5

- Interpolation is permissible; extrapolation is not.
- All entering air conditions are 80°F (26.6°C) DB and 67°F (19.4°C) WB in cooling, and 70°F (21°C) DB in heating.
- AHRI/ISO certified conditions are 80.6°F (27°C) DB and 66.2°F (19°C) WB in cooling and 68°F (20°C) DB in heating.
- Table does not reflect fan or pump power corrections for AHRI/ISO conditions.
- All performance is based upon the lower voltage of dual voltage rated units.
- Performance stated is at the rated power supply; performance may vary as the power supply varies from the rated.
- Operation below 40°F (10.0°C) EWT is based upon 20% methanol antifreeze solution.
- Operation below 60°F (15.5°C) EWT requires optional insulated water/refrigerant circuit.
- See performance correction tables for operating conditions other than those listed above.
- See Performance Data Selection Notes for operation in the shaded areas.
- Regular Cooling operation with an EWT of less than 50°F (10.0°C) is not recommended unless variable water flow is available.
- Regular Heating operation with an EWT of more than 90°F (32°C) is not recommended unless variable water flow is available.
- For quiet operation and long term reliability, it is recommended that systems be designed to avoid continuous operation in the outlined areas.
- Performance capacities shown in thousands of Btuh
- Hot Water Generator Capacity is based on 90°F entering water and 0.5 GPM/Ton.

ClimateMaster works continually to improve its products. As a result, the design and specifications of each product at the time of order may be changed without notice and may not be as described herein. Please contact ClimateMaster's Customer Service Department at 800-299-9747 for specific information on the current design and specifications. Statements and other information contained herein are not express warranties and do not form the basis of any bargain between the parties, but are merely ClimateMaster's opinion or commendation of its products. The latest version of this document is available at www.climatemaster.com. Engineered and assembled in the USA. © ClimateMaster, Inc. All Rights Reserved 2024

Performance Data SE*048 EC Blower Motor (Full Load)

Models:
SE
024-072

1600 CFM Rated Airflow

EWT °F	WPD			COOLING - EAT 80/67 °F							WPD			HEATING - EAT 70°F															
	FLOW GPM	PSI	FT	TC	SC	EC					FLOW GPM	PSI	FT	HC	EC														
						kW	HR	EER	LWT	HWG Cap					kW	HE	COP	LWT	HWG Cap										
20	Operation Not Recommended										12.00	3.4	7.8	34.0	2.95	23.9	3.4	16.0	3.2										
30	4.35	0.4	0.9	57.7	37.5	2.21	65.2	26.1	60.0	1.2	6.00	1.0	2.4	36.5	2.98	26.3	3.6	21.2	3.6										
											9.00	1.9	4.5	37.9	3.00	27.6	3.7	23.9	3.9										
40	6.31	1.0	2.3	55.5	36.2	2.22	63.1	25.0	60.0	1.2	12.00	3.1	7.2	38.7	3.01	28.4	3.8	25.3	4.3										
											6.00	0.9	2.2	41.3	3.05	30.9	4.0	29.7	4.0										
											9.00	1.8	4.2	43.2	3.08	32.6	4.1	32.7	4.3										
50	6.00	0.9	2.1	55.7	37.2	2.47	64.2	22.6	71.4	2.3	12.00	2.9	6.7	44.2	3.11	33.6	4.2	34.4	4.5										
											6.00	0.9	2.1	46.6	3.15	35.9	4.3	38.0	4.4										
											9.00	1.7	3.9	49.0	3.20	38.1	4.5	41.5	4.8										
60	6.00	0.9	2.0	54.5	37.1	2.71	63.7	20.1	81.2	3.1	12.00	2.8	6.4	50.3	3.23	39.3	4.6	43.5	5.0										
											6.00	0.9	2.0	52.3	3.28	41.1	4.7	46.3	4.8										
											9.00	1.6	3.8	55.5	37.3	2.53	64.1	21.9	74.3	2.8	9.00	1.6	3.8	55.1	3.34	43.7	4.8	50.3	5.3
70	6.00	0.9	2.0	52.3	36.2	2.98	62.4	17.6	90.8	4.0	12.00	2.7	6.2	56.6	3.38	45.1	4.9	52.5	5.7										
											6.00	0.9	2.0	58.1	3.41	46.4	5.0	54.5	5.3										
											9.00	1.6	3.7	53.9	36.9	2.78	63.4	19.4	84.1	3.6	9.00	1.6	3.7	61.2	3.49	49.3	5.1	59.0	5.9
80	6.00	0.8	2.0	49.4	34.8	3.28	60.6	15.1	100.2	5.0	12.00	2.6	6.1	62.9	3.53	50.9	5.2	61.5	6.4										
											6.00	0.8	2.0	63.8	3.55	51.6	5.3	62.8	5.9										
											9.00	1.6	3.7	51.4	35.8	3.07	61.9	16.8	93.8	4.6	9.00	1.6	3.7	67.1	3.63	54.7	5.4	67.8	6.5
85	6.00	0.8	2.0	47.9	34.0	3.44	59.6	13.9	104.9	5.6	12.00	2.6	6.0	68.8	3.68	56.3	5.5	70.6	7.1										
											6.00	0.8	2.0	66.5	3.62	54.2	5.4	66.9	6.2										
											9.00	1.6	3.7	50.0	35.1	3.22	61.0	15.5	98.5	4.9	9.00	1.6	3.7	69.8	3.70	57.2	5.5	72.3	6.8
90	6.00	0.8	2.0	46.3	33.2	3.62	58.6	12.8	109.5	6.2	12.00	2.6	5.9	71.6	3.74	58.8	5.6	75.2	7.4										
											6.00	0.8	2.0	68.5	3.67	56.0	5.5	70.0	7.4										
											9.00	1.6	3.7	48.4	34.3	3.38	60.0	14.3	103.3	5.7	5.60	0.1	0.2	68.5	3.67	56.0	5.5	70.0	7.4
100	6.00	0.8	2.0	43.1	31.4	4.00	56.7	10.8	118.9	7.5	12.00	2.5	5.9	68.5	3.67	56.0	5.5	70.0	7.4										
											6.00	0.8	2.0	68.5	3.67	56.0	5.5	70.0	7.4										
											9.00	1.6	3.6	45.2	32.5	3.75	57.9	12.0	112.9	6.8	3.73	0.1	0.2	68.5	3.67	56.0	5.5	70.0	7.4
110	6.00	0.8	1.9	40.0	29.7	4.45	55.2	9.0	128.4	8.9	12.00	2.5	5.8	68.5	3.67	56.0	5.5	70.0	7.4										
											6.00	0.8	1.9	40.0	29.7	4.45	55.2	9.0	128.4	8.9	2.80	0.1	0.2	68.5	3.67	56.0	5.5	70.0	7.4
											9.00	1.6	3.6	41.9	30.7	4.16	56.1	10.1	122.5	8.2	2.80	0.1	0.2	68.5	3.67	56.0	5.5	70.0	7.4
120	6.00	0.8	1.9	37.3	28.4	4.96	54.2	7.5	138.1	10.5	12.00	2.5	5.7	68.5	3.67	56.0	5.5	70.0	7.4										
											6.00	0.8	1.9	37.3	28.4	4.96	54.2	7.5	138.1	10.5	2.24	0.1	0.2	68.5	3.67	56.0	5.5	70.0	7.4
											9.00	1.5	3.5	38.9	29.1	4.64	54.7	8.4	132.2	9.6	2.24	0.1	0.2	68.5	3.67	56.0	5.5	70.0	7.4

- Interpolation is permissible; extrapolation is not.
- All entering air conditions are 80°F (26.6°C) DB and 67°F (19.4°C) WB in cooling, and 70°F (21°C) DB in heating.
- AHRI/ISO certified conditions are 80.6°F (27°C) DB and 66.2°F (19°C) WB in cooling and 68°F (20°C) DB in heating.
- Table does not reflect fan or pump power corrections for AHRI/ISO conditions.
- All performance is based upon the lower voltage of dual voltage rated units.
- Performance stated is at the rated power supply; performance may vary as the power supply varies from the rated.
- Operation below 40°F (10.0°C) EWT is based upon 20% methanol antifreeze solution.
- Operation below 60°F (15.5°C) EWT requires optional insulated water/refrigerant circuit.
- See performance correction tables for operating conditions other than those listed above.
- See Performance Data Selection Notes for operation in the shaded areas.
- Regular Cooling operation with an EWT of less than 50°F (10.0°C) is not recommended unless variable water flow is available.
- Regular Heating operation with an EWT of more than 90°F (32°C) is not recommended unless variable water flow is available.
- For quiet operation and long term reliability, it is recommended that systems be designed to avoid continuous operation in the outlined areas.
- Performance capacities shown in thousands of Btuh
- Hot Water Generator Capacity is based on 90°F entering water and 0.5 GPM/Ton.

ClimateMaster works continually to improve its products. As a result, the design and specifications of each product at the time of order may be changed without notice and may not be as described herein. Please contact ClimateMaster's Customer Service Department at 800-299-9747 for specific information on the current design and specifications. Statements and other information contained herein are not express warranties and do not form the basis of any bargain between the parties, but are merely ClimateMaster's opinion or commendation of its products. The latest version of this document is available at www.climatemaster.com. Engineered and assembled in the USA. © ClimateMaster, Inc. All Rights Reserved 2024

Performance Data SE*060 EC Blower Motor (Part Load)

Models:
SE
024-072

1700 CFM Rated Airflow

EWT °F	WPD			COOLING - EAT 80/67 °F							WPD			HEATING - EAT 70°F						
	FLOW GPM	PSI	FT	TC	SC	EC					FLOW GPM	PSI	FT	HC	EC					
						kW	HR	EER	LWT	HWG Cap					kW	HE	COP	LWT	HWG Cap	
20	Operation Not Recommended										10.50	3.6	8.3	24.3	2.49	15.8	2.9	17.0	3.0	
30	3.81	0.7	1.5	48.9	35.9	1.45	53.9	33.8	50.5	1.3	5.25	1.2	2.8	26.7	2.51	18.2	3.1	23.1	3.0	
											7.95	2.2	5.1	27.6	2.51	19.1	3.2	25.2	3.1	
40	5.55	1.0	2.4	50.4	38.1	1.63	55.9	31.0	61.3	1.3	10.50	3.1	7.2	28.1	2.52	19.5	3.3	26.3	3.1	
											5.25	0.9	2.2	30.6	2.53	22.0	3.5	31.6	3.1	
											7.95	1.9	4.3	31.9	2.54	23.2	3.7	34.2	3.2	
50	5.55	1.0	2.4	50.4	38.1	1.63	55.9	31.0	61.3	1.3	10.50	2.7	6.3	32.5	2.54	23.9	3.8	35.5	3.3	
											5.25	0.8	1.8	34.9	2.55	26.2	4.0	40.0	3.3	
											7.95	1.6	3.7	36.5	2.56	27.8	4.2	43.0	3.4	
60	5.55	1.0	2.4	50.4	38.1	1.63	55.9	31.0	61.3	1.3	10.50	2.4	5.6	37.4	2.56	28.6	4.3	44.5	3.5	
											5.25	0.6	1.5	39.5	2.57	30.7	4.5	48.3	3.5	
											7.95	1.4	3.3	41.5	2.58	32.7	4.7	51.8	3.7	
70	5.55	1.0	2.4	50.4	38.1	1.63	55.9	31.0	61.3	1.3	10.50	2.2	5.1	42.5	2.58	33.7	4.8	53.6	3.8	
											5.25	0.6	1.3	44.2	2.59	35.4	5.0	56.5	3.9	
											7.95	1.3	3.1	46.6	2.59	37.7	5.3	60.5	4.0	
80	5.55	1.0	2.4	50.4	38.1	1.63	55.9	31.0	61.3	1.3	10.50	2.0	4.7	47.8	2.60	39.0	5.4	62.6	4.1	
											5.25	0.6	1.3	49.1	2.60	40.2	5.5	64.7	4.2	
											7.95	1.2	2.9	51.8	2.61	42.9	5.8	69.2	4.4	
85	5.55	1.0	2.4	50.4	38.1	1.63	55.9	31.0	61.3	1.3	10.50	1.9	4.4	53.3	2.61	44.4	6.0	71.6	4.5	
											5.25	0.5	1.3	51.6	2.61	42.7	5.8	68.7	4.4	
											7.95	1.2	2.8	54.5	2.61	45.6	6.1	73.5	4.5	
90	5.55	1.0	2.4	50.4	38.1	1.63	55.9	31.0	61.3	1.3	10.50	1.8	4.3	56.0	2.61	47.1	6.3	76.0	4.7	
											5.25	0.5	1.3	51.6	2.61	42.7	5.8	68.7	4.4	
											7.95	1.2	2.8	54.5	2.61	45.6	6.1	73.5	4.5	
100	5.55	1.0	2.4	50.4	38.1	1.63	55.9	31.0	61.3	1.3	4.34	0.1	0.2	52.3	2.61	43.4	5.9	70.0	4.7	
											5.25	0.5	1.3	51.6	2.61	42.7	5.8	68.7	4.4	
											7.95	1.2	2.8	54.5	2.61	45.6	6.1	73.5	4.5	
110	5.55	1.0	2.4	50.4	38.1	1.63	55.9	31.0	61.3	1.3	2.9	0.1	0.23	52.3	2.61	43.44	5.88	70.0	4.7	
											5.25	0.5	1.3	51.6	2.61	42.7	5.8	68.7	4.4	
											7.95	1.2	2.8	54.5	2.61	45.6	6.1	73.5	4.5	
120	5.55	1.0	2.4	50.4	38.1	1.63	55.9	31.0	61.3	1.3	2.17	0.1	0.23	52.3	2.61	43.44	5.88	70.0	4.7	
											5.25	0.5	1.2	36.2	34.7	3.84	49.3	9.4	128.8	7.9
											7.95	1.2	2.7	37.0	35.0	3.55	49.2	10.4	122.4	7.6
120	5.55	1.0	2.4	50.4	38.1	1.63	55.9	31.0	61.3	1.3	1.74	0.1	0.23	52.3	2.61	43.44	5.88	70.0	4.7	
											5.25	0.5	1.2	36.1	35.4	4.34	50.9	8.3	139.4	9.6
											7.95	1.1	2.6	35.9	34.8	4.01	49.6	9.0	132.5	9.4
120	5.55	1.0	2.4	50.4	38.1	1.63	55.9	31.0	61.3	1.3	10.50	1.7	4.0	36.1	34.7	3.86	49.3	9.3	129.4	9.1
											7.95	1.1	2.6	35.9	34.8	4.01	49.6	9.0	132.5	9.4

- Interpolation is permissible; extrapolation is not.
- All entering air conditions are 80°F (26.6°C) DB and 67°F (19.4°C) WB in cooling, and 70°F (21°C) DB in heating.
- AHRI/ISO certified conditions are 80.6°F (27°C) DB and 66.2°F (19°C) WB in cooling and 68°F (20°C) DB in heating.
- Table does not reflect fan or pump power corrections for AHRI/ISO conditions.
- All performance is based upon the lower voltage of dual voltage rated units.
- Performance stated is at the rated power supply; performance may vary as the power supply varies from the rated.
- Operation below 40°F (10.0°C) EWT is based upon 20% methanol antifreeze solution.
- Operation below 60°F (15.5°C) EWT requires optional insulated water/refrigerant circuit.
- See performance correction tables for operating conditions other than those listed above.
- See Performance Data Selection Notes for operation in the shaded areas.
- Regular Cooling operation with an EWT of less than 50°F (10.0°C) is not recommended unless variable water flow is available.
- Regular Heating operation with an EWT of more than 90°F (32°C) is not recommended unless variable water flow is available.
- For quiet operation and long term reliability, it is recommended that systems be designed to avoid continuous operation in the outlined areas.
- Performance capacities shown in thousands of Btuh
- Hot Water Generator Capacity is based on 90°F entering water and 0.5 GPM/Ton.

ClimateMaster works continually to improve its products. As a result, the design and specifications of each product at the time of order may be changed without notice and may not be as described herein. Please contact ClimateMaster's Customer Service Department at 800-299-9747 for specific information on the current design and specifications. Statements and other information contained herein are not express warranties and do not form the basis of any bargain between the parties, but are merely ClimateMaster's opinion or commendation of its products. The latest version of this document is available at www.climatemaster.com. Engineered and assembled in the USA. © ClimateMaster, Inc. All Rights Reserved 2024

Performance Data SE*060 EC Blower Motor (Full Load)

Models:
SE
024-072

1900 CFM Rated Airflow

EWT °F	WPD			COOLING - EAT 80/67 °F							WPD			HEATING - EAT 70°F										
	FLOW GPM	PSI	FT	TC	SC	EC					FLOW GPM	PSI	FT	HC	EC									
						kW	HR	EER	LWT	HWG Cap					kW	HE	COP	LWT	HWG Cap					
20	Operation Not Recommended										15.00	6.5	15.0	38.9	3.44	27.1	3.3	16.4	3.9					
30	5.41	1.0	2.3	71.7	50.2	2.74	81.1	26.2	60.0	2.4	7.50	2.0	4.6	42.4	3.50	30.4	3.5	21.9	4.2					
											11.25	3.8	8.8	44.0	3.53	31.9	3.6	24.3	4.3					
											15.00	5.6	13.0	44.8	3.55	32.7	3.7	25.6	4.3					
40	7.68	1.7	3.9	67.5	47.6	2.71	76.8	24.9	60.0	2.4	7.50	1.6	3.7	48.1	3.60	35.8	3.9	30.5	4.5					
											11.25	3.3	7.6	50.1	3.64	37.7	4.0	33.3	4.5					
											15.00	4.9	11.4	51.2	3.66	38.7	4.1	34.8	4.5					
50	7.50	1.3	3.1	68.9	49.2	3.02	79.3	22.8	71.1	3.6	7.50	1.3	3.1	54.1	3.71	41.5	4.3	38.9	4.9					
											11.25	2.9	6.6	56.5	3.75	43.7	4.4	42.2	5.0					
											15.00	4.4	10.2	57.8	3.78	44.9	4.5	44.0	5.1					
60	7.50	1.2	2.7	67.9	49.3	3.31	79.2	20.5	81.1	3.8	7.50	1.2	2.7	60.3	3.83	47.3	4.6	47.4	5.4					
											11.25	2.6	6.0	63.1	3.88	49.9	4.8	51.1	5.6					
											15.00	4.0	9.3	64.6	3.91	51.3	4.8	53.2	5.8					
70	7.50	1.1	2.5	65.4	48.5	3.62	77.7	18.0	90.7	4.6	7.50	1.1	2.5	66.6	3.95	53.2	4.9	55.8	5.9					
											11.25	2.4	5.6	69.8	4.02	56.1	5.1	60.0	6.4					
											15.00	3.7	8.6	71.5	4.06	57.7	5.2	62.3	6.8					
80	7.50	1.0	2.4	61.9	47.0	3.97	75.4	15.6	100.1	5.6	7.50	1.0	2.4	73.0	4.09	59.0	5.2	64.3	6.4					
											11.25	2.3	5.3	76.4	4.17	62.2	5.4	68.9	7.1					
											15.00	3.5	8.2	78.3	4.22	63.9	5.4	71.5	7.6					
85	7.50	1.0	2.4	60.0	46.1	4.16	74.2	14.4	104.8	6.3	7.50	1.0	2.4	76.1	4.16	61.9	5.4	68.5	6.8					
											11.25	2.3	5.2	79.7	4.25	65.2	5.5	73.4	7.4					
											15.00	3.5	8.0	81.6	4.30	66.9	5.6	76.1	8.0					
90	7.50	1.0	2.4	58.0	45.2	4.36	72.9	13.3	109.4	7.4	6.30	0.1	0.2	77.2	4.19	63.0	5.4	70.0	8.0					
																				11.25	2.2	5.2	103.3	6.6
																				15.00	3.4	7.9	100.1	6.1
100	7.50	1.0	2.4	54.1	43.4	4.83	70.6	11.2	118.8	8.9	1.82	0.1	0.2	33.1	1.72	27.2	5.6	70.0	8.0					
																				11.25	2.2	5.1	112.8	8.2
																				15.00	3.3	7.7	109.7	7.4
110	7.50	1.0	2.3	50.6	41.8	5.39	69.0	9.4	128.4	10.7	1.36	0.1	0.2	33.1	1.72	27.2	5.6	70.0	8.0					
																				11.25	2.1	4.9	122.4	9.8
																				15.00	3.3	7.6	119.4	8.9
120	7.50	0.9	2.1	48.1	41.0	6.07	68.8	7.9	138.3	12.4	1.09	0.1	0.2	33.1	1.72	27.2	5.6	70.0	8.0					
																				11.25	2.1	4.8	132.2	11.2
																				15.00	3.2	7.5	129.2	10.6

- Interpolation is permissible; extrapolation is not.
- All entering air conditions are 80°F (26.6°C) DB and 67°F (19.4°C) WB in cooling, and 70°F (21°C) DB in heating.
- AHRI/ISO certified conditions are 80.6°F (27°C) DB and 66.2°F (19°C) WB in cooling and 68°F (20°C) DB in heating.
- Table does not reflect fan or pump power corrections for AHRI/ISO conditions.
- All performance is based upon the lower voltage of dual voltage rated units.
- Performance stated is at the rated power supply; performance may vary as the power supply varies from the rated.
- Operation below 40°F (10.0°C) EWT is based upon 20% methanol antifreeze solution.
- Operation below 60°F (15.5°C) EWT requires optional insulated water/refrigerant circuit.
- See performance correction tables for operating conditions other than those listed above.
- See Performance Data Selection Notes for operation in the shaded areas.
- Regular Cooling operation with an EWT of less than 50°F (10.0°C) is not recommended unless variable water flow is available.
- Regular Heating operation with an EWT of more than 90°F (32°C) is not recommended unless variable water flow is available.
- For quiet operation and long term reliability, it is recommended that systems be designed to avoid continuous operation in the outlined areas.
- Performance capacities shown in thousands of Btuh
- Hot Water Generator Capacity is based on 90°F entering water and 0.5 GPM/Ton.

ClimateMaster works continually to improve its products. As a result, the design and specifications of each product at the time of order may be changed without notice and may not be as described herein. Please contact ClimateMaster's Customer Service Department at 800-299-9747 for specific information on the current design and specifications. Statements and other information contained herein are not express warranties and do not form the basis of any bargain between the parties, but are merely ClimateMaster's opinion or commendation of its products. The latest version of this document is available at www.climatemaster.com. Engineered and assembled in the USA. © ClimateMaster, Inc. All Rights Reserved 2024

Performance Data SE*072 EC Blower Motor (Part Load)

Models:
SE
024-072

1700 CFM Rated Airflow

EWT °F	WPD			COOLING - EAT 80/67 °F							WPD			HEATING - EAT 70°F					
	FLOW GPM	PSI	FT	TC	SC	EC					FLOW GPM	PSI	FT	HC	EC				
						kW	HR	EER	LWT	HWG Cap					kW	HE	COP	LWT	HWG Cap
20	Operation Not Recommended										13.70	5.1	11.9	32.8	3.26	21.7	2.9	16.8	3.9
30	4.7	0.6	1.4	63.8	46.5	2.0	70.6	31.9	60.0	1.9	6.90	1.6	3.7	36.4	3.33	25.1	3.2	22.7	4.2
											10.30	3.1	7.2	37.7	3.34	26.3	3.3	24.9	4.3
											13.70	4.6	10.7	38.3	3.35	26.9	3.4	26.1	4.4
40	6.87	1.4	3.2	61.6	44.9	2.07	68.7	29.8	60.0	1.9	6.90	1.4	3.2	41.1	3.37	29.6	3.6	31.4	4.5
											10.30	2.8	6.5	42.4	3.37	30.9	3.7	34.0	4.6
											13.70	4.2	9.8	43.1	3.38	31.5	3.7	35.4	4.8
50	6.90	1.3	2.9	61.4	45.5	2.35	69.4	26.1	70.1	2.7	6.90	1.3	2.9	45.4	3.38	33.9	3.9	40.2	4.9
	10.30	2.6	6.0	61.7	45.2	2.16	69.1	28.6	63.4	2.6	10.30	2.6	6.0	46.8	3.37	35.3	4.1	43.1	5.1
	13.70	3.9	9.0	61.6	44.9	2.07	68.7	29.7	60.0	2.5	13.70	3.9	9.0	47.6	3.37	36.1	4.1	44.7	5.2
60	6.90	1.2	2.7	59.9	45.1	2.68	69.0	22.3	80.0	3.3	6.90	1.2	2.7	49.8	3.37	38.3	4.3	48.9	5.4
	10.30	2.4	5.6	61.0	45.4	2.46	69.4	24.8	73.5	3.2	10.30	2.4	5.6	51.6	3.38	40.1	4.5	52.2	5.6
	13.70	3.7	8.5	61.4	45.5	2.35	69.4	26.1	70.1	3.1	13.70	3.7	8.5	52.6	3.38	41.1	4.6	54.0	5.7
70	6.90	1.1	2.5	57.4	44.0	3.07	67.9	18.7	89.7	4.1	6.90	1.1	2.5	54.7	3.40	43.1	4.7	57.5	6.0
	10.30	2.3	5.3	59.1	44.8	2.81	68.7	21.0	83.3	4.0	10.30	2.3	5.3	57.2	3.42	45.5	4.9	61.2	6.2
	13.70	3.5	8.1	59.9	45.1	2.69	69.0	22.3	80.1	3.9	13.70	3.5	8.1	58.6	3.44	46.9	5.0	63.2	6.4
80	6.90	1.0	2.4	54.4	42.5	3.49	66.3	15.6	99.2	5.1	6.90	1.0	2.4	60.7	3.48	48.8	5.1	65.8	6.7
	10.30	2.2	5.1	56.4	43.5	3.21	67.4	17.6	93.1	5.0	10.30	2.2	5.1	64.1	3.54	52.0	5.3	69.9	6.9
	13.70	3.3	7.7	57.4	44.0	3.08	67.9	18.7	89.9	4.8	13.70	3.3	7.7	66.1	3.58	53.9	5.4	72.1	7.1
85	6.90	1.0	2.3	52.7	41.7	3.73	65.4	14.1	104.0	6.0	6.90	1.0	2.3	64.1	3.54	52.0	5.3	69.9	7.0
	10.30	2.1	5.0	54.8	42.7	3.43	66.5	16.0	97.9	5.7	10.30	2.1	5.0	68.2	3.63	55.8	5.5	74.2	7.3
	13.70	3.3	7.6	55.8	43.2	3.29	67.1	17.0	94.8	5.5	13.70	3.3	7.6	70.6	3.69	58.0	5.6	76.5	7.4
90	6.90	1.0	2.3	50.9	40.8	3.97	64.5	12.8	108.7	6.3	5.16	0.1	0.2	63.5	3.51	51.6	5.3	70.0	7.4
	10.30	2.1	4.8	53.1	41.9	3.67	65.6	14.5	102.7	6.1									
	13.70	3.2	7.4	54.2	42.4	3.52	66.2	15.4	99.7	5.9									
100	6.90	0.9	2.1	47.3	39.2	4.49	62.7	10.5	118.2	7.6	3.44	0.1	0.2	63.5	3.51	51.6	5.3	70.0	7.4
	10.30	2.0	4.6	49.5	40.2	4.17	63.7	11.9	112.4	7.4									
	13.70	3.1	7.1	50.7	40.7	4.01	64.3	12.6	109.4	7.1									
110	6.90	0.8	2.0	43.8	37.7	5.06	61.1	8.7	127.7	9.1	2.58	0.1	0.2	63.5	3.51	51.6	5.3	70.0	7.4
	10.30	1.9	4.4	45.9	38.5	4.72	62.0	9.7	122.0	8.9									
	13.70	2.9	6.8	47.0	39.0	4.55	62.5	10.3	119.1	8.6									
120	6.90	0.7	1.7	40.7	36.7	5.69	60.1	7.2	137.4	10.8	2.06	0.1	0.2	63.5	3.51	51.6	5.31	70.0	7.4
	10.30	1.7	4.0	42.5	37.2	5.32	60.6	8.0	131.8	10.5									
	13.70	2.7	6.3	43.4	37.5	5.14	61.0	8.5	128.9	10.2									

- Interpolation is permissible; extrapolation is not.
- All entering air conditions are 80°F (26.6°C) DB and 67°F (19.4°C) WB in cooling, and 70°F (21°C) DB in heating.
- AHRI/ISO certified conditions are 80.6°F (27°C) DB and 66.2°F (19°C) WB in cooling and 68°F (20°C) DB in heating.
- Table does not reflect fan or pump power corrections for AHRI/ISO conditions.
- All performance is based upon the lower voltage of dual voltage rated units.
- Performance stated is at the rated power supply; performance may vary as the power supply varies from the rated.
- Operation below 40°F (10.0°C) EWT is based upon 20% methanol antifreeze solution.
- Operation below 60°F (15.5°C) EWT requires optional insulated water/refrigerant circuit.
- See performance correction tables for operating conditions other than those listed above.
- See Performance Data Selection Notes for operation in the shaded areas.
- Regular Cooling operation with an EWT of less than 50°F (10.0°C) is not recommended unless variable water flow is available.
- Regular Heating operation with an EWT of more than 90°F (32°C) is not recommended unless variable water flow is available.
- For quiet operation and long term reliability, it is recommended that systems be designed to avoid continuous operation in the outlined areas.
- Performance capacities shown in thousands of Btuh
- Hot Water Generator Capacity is based on 90°F entering water and 0.5 GPM/Ton.

ClimateMaster works continually to improve its products. As a result, the design and specifications of each product at the time of order may be changed without notice and may not be as described herein. Please contact ClimateMaster's Customer Service Department at 800-299-9747 for specific information on the current design and specifications. Statements and other information contained herein are not express warranties and do not form the basis of any bargain between the parties, but are merely ClimateMaster's opinion or commendation of its products. The latest version of this document is available at www.climatemaster.com. Engineered and assembled in the USA. © ClimateMaster, Inc. All Rights Reserved 2024

Performance Data SE*072 EC Blower Motor (Full Load)

Models:
SE
024-072

1900 CFM Rated Airflow

EWT °F	WPD			COOLING - EAT 80/67 °F							WPD			HEATING - EAT 70°F					
	FLOW GPM	PSI	FT	TC	SC	EC					FLOW GPM	PSI	FT	HC	EC				
						kW	HR	EER	LWT	HWG Cap					kW	HE	COP	LWT	HWG Cap
20	Operation Not Recommended										17.00	7.6	17.7	47.9	4.22	33.5	3.3	16.1	4.2
30	6.09	0.9	2.0	79.7	56.4	3.42	91.3	23.3	60.0	2.4	8.50	2.2	5.0	50.2	4.37	35.3	3.4	21.7	4.3
											12.75	4.5	10.4	51.5	4.44	36.3	3.4	24.3	4.3
											17.00	6.8	15.7	52.2	4.48	36.9	3.4	25.7	4.3
40	8.93	2.1	4.8	77.8	54.8	3.37	89.3	23.1	60.0	2.4	8.50	1.9	4.3	55.0	4.61	39.2	3.5	30.8	4.5
											12.75	4.0	9.3	56.7	4.69	40.7	3.5	33.6	4.5
											17.00	6.1	14.2	57.6	4.73	41.5	3.6	35.1	4.6
50	8.50	1.7	3.8	79.4	55.2	3.72	92.1	21.3	71.4	4.2	8.50	1.7	3.8	60.5	4.85	44.0	3.7	39.6	5.0
	12.75	3.6	8.4	79.9	55.1	3.48	91.8	23.0	64.1	3.8	12.75	3.6	8.4	62.7	4.93	45.9	3.7	42.8	5.1
	17.00	5.6	13.0	79.8	54.9	3.37	91.3	23.7	60.5	3.5	17.00	5.6	13.0	63.9	4.97	47.0	3.8	44.5	5.1
60	8.50	1.5	3.4	77.6	54.5	4.09	91.6	19.0	81.2	4.6	8.50	1.5	3.4	66.8	5.07	49.5	3.9	48.4	5.8
	12.75	3.4	7.8	79.0	55.1	3.82	92.1	20.7	74.2	4.4	12.75	3.4	7.8	69.5	5.16	51.8	3.9	51.9	6.5
	17.00	5.2	12.1	79.5	55.2	3.69	92.1	21.5	70.7	4.2	17.00	5.2	12.1	70.9	5.21	53.2	4.0	53.7	7.1
70	8.50	1.4	3.2	74.8	53.2	4.51	90.2	16.6	90.5	5.8	8.50	1.4	3.2	73.5	5.29	55.4	4.1	57.0	6.5
	12.75	3.2	7.3	76.9	54.2	4.20	91.2	18.3	84.0	5.2	12.75	3.2	7.3	76.7	5.39	58.3	4.2	60.9	7.3
	17.00	4.9	11.4	77.8	54.6	4.06	91.6	19.2	80.6	5.0	17.00	4.9	11.4	78.4	5.45	59.8	4.2	63.0	7.9
80	8.50	1.3	3.0	71.3	51.4	4.99	88.3	14.3	99.6	7.2	8.50	1.3	3.0	80.5	5.51	61.7	4.3	65.5	7.1
	12.75	3.0	7.0	73.8	52.7	4.64	89.7	15.9	93.5	6.7	12.75	3.0	7.0	84.2	5.62	65.0	4.4	69.8	7.9
	17.00	4.7	10.9	75.0	53.3	4.48	90.3	16.7	90.3	6.3	17.00	4.7	10.9	86.2	5.68	66.8	4.4	72.1	8.7
85	8.50	1.3	3.0	69.4	50.5	5.26	87.3	13.2	103.9	8.2	8.50	1.3	3.0	84.1	5.62	65.0	4.4	69.7	7.7
	12.75	3.0	6.8	72.0	51.8	4.89	88.7	14.7	98.2	7.4	12.75	3.0	6.8	88.0	5.73	68.5	4.5	74.3	8.1
	17.00	4.6	10.7	73.3	52.4	4.72	89.4	15.5	95.0	6.9	17.00	4.6	10.7	90.1	5.79	70.4	4.6	76.7	8.8
90	8.50	1.3	2.9	67.4	49.5	5.56	86.3	12.1	108.2	9.1	6.52	0.1	0.2	84.4	5.62	65.2	4.4	70.0	8.8
	12.75	2.9	6.7	70.1	50.8	5.16	87.7	13.6	102.7	8.3									
	17.00	4.5	10.5	71.5	51.5	4.97	88.4	14.4	99.8	7.4									
100	8.50	1.2	2.8	63.2	47.6	6.22	84.5	10.2	116.6	10.6	4.34	0.1	0.2	84.4	5.62	65.2	4.4	70.0	8.8
	12.75	2.8	6.5	66.0	48.9	5.76	85.7	11.5	111.7	9.9									
	17.00	4.4	10.2	67.4	49.5	5.55	86.4	12.2	109.0	9.0									
110	8.50	1.2	2.7	59.2	45.8	7.00	83.0	8.5	124.7	12.3	3.26	0.1	0.2	84.4	5.62	65.2	4.4	70.0	8.8
	12.75	2.7	6.3	61.8	46.9	6.47	83.9	9.6	120.5	11.7									
	17.00	4.3	9.9	63.2	47.6	6.22	84.4	10.2	118.1	10.6									
120	8.50	1.1	2.6	55.4	44.4	7.92	82.4	7.0	132.5	14.1	2.61	0.1	0.2	84.4	5.62	65.2	4.4	70.0	8.8
	12.75	2.6	6.1	57.8	45.2	7.31	82.7	7.9	129.0	13.6									
	17.00	4.1	9.6	59.1	45.8	7.02	83.0	8.4	127.0	12.4									

- Interpolation is permissible; extrapolation is not.
- All entering air conditions are 80°F (26.6°C) DB and 67°F (19.4°C) WB in cooling, and 70°F (21°C) DB in heating.
- AHRI/ISO certified conditions are 80.6°F (27°C) DB and 66.2°F (19°C) WB in cooling and 68°F (20°C) DB in heating.
- Table does not reflect fan or pump power corrections for AHRI/ISO conditions.
- All performance is based upon the lower voltage of dual voltage rated units.
- Performance stated is at the rated power supply; performance may vary as the power supply varies from the rated.
- Operation below 40°F (10.0°C) EWT is based upon 20% methanol antifreeze solution.
- Operation below 60°F (15.5°C) EWT requires optional insulated water/refrigerant circuit.
- See performance correction tables for operating conditions other than those listed above.
- See Performance Data Selection Notes for operation in the shaded areas.
- Regular Cooling operation with an EWT of less than 50°F (10.0°C) is not recommended unless variable water flow is available.
- Regular Heating operation with an EWT of more than 90°F (32°C) is not recommended unless variable water flow is available.
- For quiet operation and long term reliability, it is recommended that systems be designed to avoid continuous operation in the outlined areas.
- Performance capacities shown in thousands of Btuh
- Hot Water Generator Capacity is based on 90°F entering water and 0.5 GPM/Ton.

ClimateMaster works continually to improve its products. As a result, the design and specifications of each product at the time of order may be changed without notice and may not be as described herein. Please contact ClimateMaster's Customer Service Department at 800-299-9747 for specific information on the current design and specifications. Statements and other information contained herein are not express warranties and do not form the basis of any bargain between the parties, but are merely ClimateMaster's opinion or commendation of its products. The latest version of this document is available at www.climatemaster.com. Engineered and assembled in the USA. © ClimateMaster, Inc. All Rights Reserved 2024

Blower Performance: CV EC Standard Unit

Models:
SE
024-072

CV EC MOTOR ADVANTAGE

A major benefit of the CV EC motor over other blower motor types is its ability to adjust airflow remotely through the iGate 2 web portal/mobile app or directly at the unit with a communicating Wireless Service Tool (AWST). Airflow levels can be adjusted in increments of 25 CFM from the unit's minimum and maximum CFM range (see the Blower Performance: CV EC Blower Motor Standard Unit table for details).

Blower Performance: CV EC Blower Motor Standard Unit

Model	Max ESP (in wg)	Range	Cooling Mode			Dehumid Mode			Heating Mode		
			Stage 2	Stage 1	Fan	Stage 2	Stage 1	Fan	Stage 2	Stage 1	Fan
SE024	1.0	Minimum	600	450	300	600	450	300	600	450	300
		Default	750	575	350	650	500	350	750	575	350
		Maximum	850	650	850	800	600	850	850	850	850
SE036	0.9	Minimum	900	600	450	900	600	450	900	600	450
		Default	1,125	750	525	975	650	525	1,125	750	525
		Maximum	1,250	950	1,250	1,200	800	1,250	1,250	1,250	1,250
SE048	1.0	Minimum	1,200	900	600	1,200	900	600	1,200	900	600
		Default	1,500	1,125	700	1,300	975	700	1,500	1,125	700
		Maximum	1,700	1,300	1,700	1,600	1,200	1,700	1,700	1,700	1,700
SE060	0.7	Minimum	1,500	1,200	750	1,500	1,200	750	1,500	1,200	750
		Default	1,875	1,500	875	1,625	1,300	875	1,875	1,500	875
		Maximum	2,100	1,700	2,100	2,000	1,600	2,100	2,100	2,100	2,100
SE072	0.7	Minimum	1,500	1,200	750	1,500	1,200	750	1,500	1,200	750
		Default	1,875	1,500	875	1,625	1,300	875	1,875	1,500	875
		Maximum	2,100	1,700	2,100	2,000	1,600	2,100	2,100	2,100	2,100

- Blower performance data is based on the lowest nameplate voltage setting.
- Blower performance is based on a wet coil with clean 1-inch filter.
- Blower performance is based on operating conditions of 80°F DB and 67°F WB.
- Airflow is controlled within ±5% up to Max ESP shown with wet coil and standard 1" fiberglass air filter.
- The maximum allowable altitude of installation for this product is 6,561 ft (2,000 m).

Electrical Data: CV EC Blower Motor

Models:
SE
024-072

Units without Internal Flow Controller

Model	Voltage Code	Rated Voltage	Voltage Min/Max	Compressor				Fan Motor FLA	Pump		Total Unit FLA	Min Circ Amp	Max Fuse Calc'd	Fuse HACR
				MCC	RLA	LRA	Qty		HWG FLA	FLA				
SE*024	G.J	208/230-1-60	187/252	16.0	10.3	62.0	1	4.2	0.28	0.28	14.8	17.4	27.7	25
SE*036	G.J	208/230-1-60	187/252	22.7	14.6	76.0	1	5.9	0.28	0.28	20.8	24.4	39.0	35
SE*048	G.J	208/230-1-60	187/252	28.6	18.3	138.0	1	5.9	0.28	0.28	24.5	29.1	47.4	45
SE*060	G.J	208/230-1-60	187/252	34.8	22.3	149.0	1	7.5	0.28	0.28	30.1	35.7	58.0	50
SE*072	G.J	208/230-1-60	187/252	43.7	31.2	166.0	1	7.5	0.28	0.28	39.0	46.8	78.0	70

Note:

- Total Unit FLA includes HWG FLA

Units with Internal Flow Controller - Standard Head Variable Pump

Model	Voltage Code	Rated Voltage	Voltage Min/Max	Compressor				Fan Motor FLA	Pump		Total Unit FLA	Min Circ Amp	Max Fuse Calc'd	Fuse HACR
				MCC	RLA	LRA	Qty		Motor FLA	HWG FLA				
SE*024	G.J.	208/230-1-60	187/252	16.0	10.3	62.0	1	4.2	0.64	0.28	15.4	18.0	28.3	25
SE*036	G.J.	208/230-1-60	187/252	22.7	14.6	76.0	1	5.9	0.64	0.28	21.4	25.1	39.7	35
SE*048	G.J.	208/230-1-60	187/252	28.6	18.3	138.0	1	5.9	0.64	0.28	25.1	29.7	48.0	45
SE*060	G.J.	208/230-1-60	187/252	34.8	22.3	149.0	1	7.5	0.64	0.28	30.7	36.3	58.6	50
SE*072	G.J.	208/230-1-60	187/252	43.7	31.2	166.0	1	7.5	0.64	0.28	39.6	47.4	78.6	70

Note:

- Total Unit FLA includes HWG FLA

Units with Internal Flow Controller - High Head Variable Pump

Model	Voltage Code	Rated Voltage	Voltage Min/Max	Compressor				Fan Motor FLA	Pump		Total Unit FLA	Min Circ Amp	Max Fuse Calc'd	Fuse HACR
				MCC	RLA	LRA	Qty		Motor FLA	HWG FLA				
SE*024	G.J.	208/230-1-60	187/252	16.0	10.3	62.0	1	4.2	1.44	0.28	16.2	18.8	29.1	25
SE*036	G.J.	208/230-1-60	187/252	22.7	14.6	76.0	1	5.9	1.44	0.28	22.2	25.9	40.5	40
SE*048	G.J.	208/230-1-60	187/252	28.6	18.6	138.0	1	5.9	1.44	0.28	25.9	30.5	48.8	45
SE*060	G.J.	208/230-1-60	187/252	34.8	22.3	149.0	1	7.5	1.44	0.28	31.5	37.1	59.4	50
SE*072	G.J.	208/230-1-60	187/252	43.7	31.2	166.0	1	7.5	1.44	0.28	40.4	48.2	79.4	70

Note:

- Total Unit FLA includes HWG FLA

Part Load Performance: Correction Tables

Models:
SE
024-072

Cooling Correction

Entering Air WB °F	Total Capacity	Sensible Cooling Capacity Multipliers - Entering DB °F									Power	Heat of Rejection
		65	70	75	80	80.6	85	90	95	100		
50	0.883	1.099	1.241	*	*	*	*	*	*	*	0.985	0.901
55	0.903	0.871	1.060	1.271	*	*	*	*	*	*	0.989	0.918
60	0.935	0.617	0.844	1.079	1.319	1.349	*	*	*	*	0.993	0.945
65	0.979		0.595	0.849	1.096	1.128	1.342	*	*	*	0.998	0.982
66.2	0.991		0.531	0.789	1.040	1.070	1.284	1.522	*	*	0.999	0.993
67	1.000		0.486	0.747	1.000	1.030	1.245	1.481	*	*	1.000	1.000
70	1.035			0.583	0.842	0.873	1.090	1.327	1.552	*	1.003	1.030
75	1.105				0.552	0.584	0.811	1.057	1.290	1.510	1.008	1.088

Notes:

- AHRI/ISO/ASHRAE 13256-1 uses entering air conditions of Cooling - 80.6°F (27°C) DB/ 66.2°F (19°C) WB, and Heating 68°F (20°C) DB/ 59°F (15°C) WB entering air temperature.
- Asterisks indicate that no correction factor is needed, Total Capacity equals Sensible capacity.
- Entering DB temperature range is based on operating limits, not on commission limits.
- Cooling and heating air corrections based on rated airflow.

Entering Air Heating Correction

Entering Air WB °F	Heating Capacity	Power	Heat of Rejection
40	1.084	0.732	1.161
45	1.073	0.764	1.140
50	1.060	0.802	1.117
55	1.046	0.846	1.090
60	1.031	0.893	1.061
65	1.016	0.945	1.031
68	1.006	0.978	1.013
70	1.000	1.000	1.000
75	0.984	1.058	0.968
80	0.968	1.117	0.936

Airflow Correction

Airflow % of Rated	Cooling				Heating		
	Total Capacity	Sensible Capacity	Power	Heat of Rejection	Heating Capacity	Power	Heat of Extraction
60%	0.920	0.781	0.959	0.927	0.946	1.241	0.881
69%	0.942	0.832	0.964	0.946	0.960	1.163	0.915
75%	0.956	0.867	0.696	0.959	0.969	1.115	0.937
81%	0.969	0.901	0.975	0.970	0.978	1.076	0.956
88%	0.981	0.934	0.982	0.981	0.986	1.043	0.973
94%	0.991	0.967	0.990	0.991	0.993	1.018	0.988
100%	1.000	1.000	1.000	1.000	1.000	1.000	1.000
106%	1.007	1.033	1.011	1.008	1.006	0.990	1.010
113%	1.013	1.065	1.023	1.015	1.012	0.986	1.017
119%	1.018	1.098	1.036	1.021	1.017	0.983	1.024
125%	1.021	1.131	1.051	1.026	1.021	0.981	1.030
130%	1.023	1.159	1.063	1.030	1.024	0.979	1.034

ClimateMaster works continually to improve its products. As a result, the design and specifications of each product at the time of order may be changed without notice and may not be as described herein. Please contact ClimateMaster's Customer Service Department at 800-299-9747 for specific information on the current design and specifications. Statements and other information contained herein are not express warranties and do not form the basis of any bargain between the parties, but are merely ClimateMaster's opinion or commendation of its products. The latest version of this document is available at www.climatemaster.com. Engineered and assembled in the USA. © ClimateMaster, Inc. All Rights Reserved 2024

Full Load Performance: Correction Tables

Cooling Correction

Entering Air WB °F	Total Capacity	Sensible Cooling Capacity Multipliers - Entering DB °F									Power	Heat of Rejection
		65	70	75	80	80.6	85	90	95	100		
50	0.850	1.174	*	*	*	*	*	*	*	*	0.953	0.87
55	0.880	0.902	1.115	*	*	*	*	*	*	*	0.964	0.896
60	0.922	0.646	0.875	1.103	1.329	*	*	*	*	*	0.977	0.932
65	0.975		0.639	0.869	1.096	1.123	1.320	*	*	*	0.993	0.979
66.2	0.990		0.582	0.812	1.039	1.066	1.262	*	*	*	0.997	0.991
67	1.000		0.545	0.774	1.000	1.027	1.223	1.444	*	*	1.000	1.000
70	1.040			0.630	0.853	0.880	1.075	1.297	*	*	1.011	1.035
75	1.117				0.601	0.627	0.821	1.046	1.275	1.510	1.033	1.101

Notes:

- AHRI/ISO/ASHRAE 13256-1 uses entering air conditions of Cooling - 80.6°F (27°C) DB/ 66.2°F (19°C) WB, and Heating 68°F (20°C) DB/ 59°F (15°C) WB entering air temperature.
- Asterisks indicate that no correction factor is needed, Total Capacity equals Sensible capacity.
- Entering DB temperature range is based on operating limits, not on commission limits.
- Cooling and heating air corrections based on rated airflow.

Entering Air Heating Correction

Entering Air WB °F	Heating Capacity	Power	Heat of Rejection
40	1.052	0.779	1.120
45	1.043	0.808	1.102
50	1.035	0.841	1.084
55	1.027	0.877	1.065
60	1.019	0.915	1.045
65	1.010	0.957	1.023
68	1.004	0.982	1.010
70	1.000	1.000	1.000
75	0.989	1.045	0.974
80	0.976	1.093	0.946

Airflow Correction

Airflow % of Rated	Cooling				Heating		
	Total Capacity	Sensible Capacity	Power	Heat of Rejection	Heating Capacity	Power	Heat of Extraction
60%	0.925	0.788	0.913	0.922	0.946	1.153	0.896
69%	0.946	0.829	0.926	0.942	0.959	1.107	0.924
75%	0.960	0.861	0.937	0.955	0.969	1.078	0.942
81%	0.972	0.895	0.950	0.968	0.977	1.053	0.959
88%	0.983	0.930	0.965	0.979	0.985	1.032	0.974
94%	0.992	0.965	0.982	0.990	0.993	1.014	0.988
100%	1.000	1.000	1.000	1.000	1.000	1.000	1.000
106%	1.007	1.033	1.020	1.009	1.006	0.989	1.011
113%	1.012	1.064	1.042	1.018	1.012	0.982	1.019
119%	1.016	1.092	1.066	1.025	1.018	0.979	1.027
125%	1.018	1.116	1.091	1.032	1.022	0.977	1.033
130%	1.019	1.132	1.112	1.037	1.026	0.975	1.038

ClimateMaster works continually to improve its products. As a result, the design and specifications of each product at the time of order may be changed without notice and may not be as described herein. Please contact ClimateMaster's Customer Service Department at 800-299-9747 for specific information on the current design and specifications. Statements and other information contained herein are not express warranties and do not form the basis of any bargain between the parties, but are merely ClimateMaster's opinion or commendation of its products. The latest version of this document is available at www.climatemaster.com. Engineered and assembled in the USA. © ClimateMaster, Inc. All Rights Reserved 2024

High Head and Standard Variable Pump Performance

Models:
SE
024-072

Standard Head Variable Pump Performance

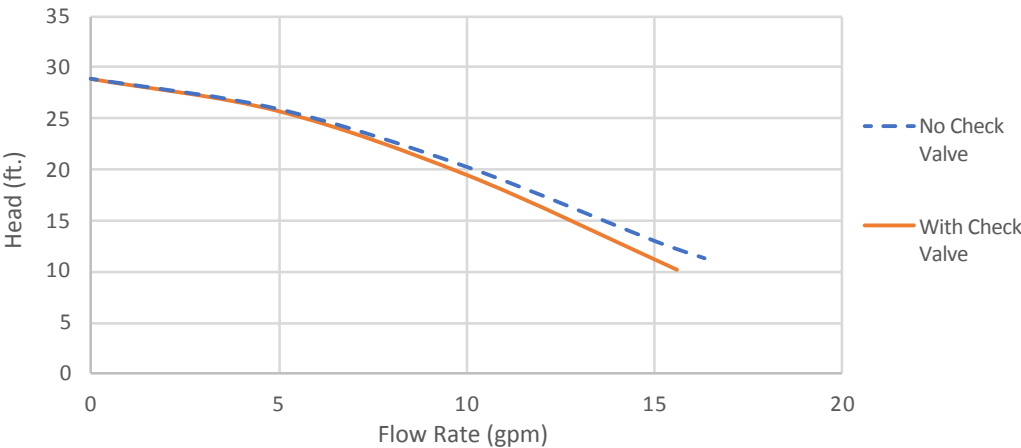

High Head Variable Pump Performance

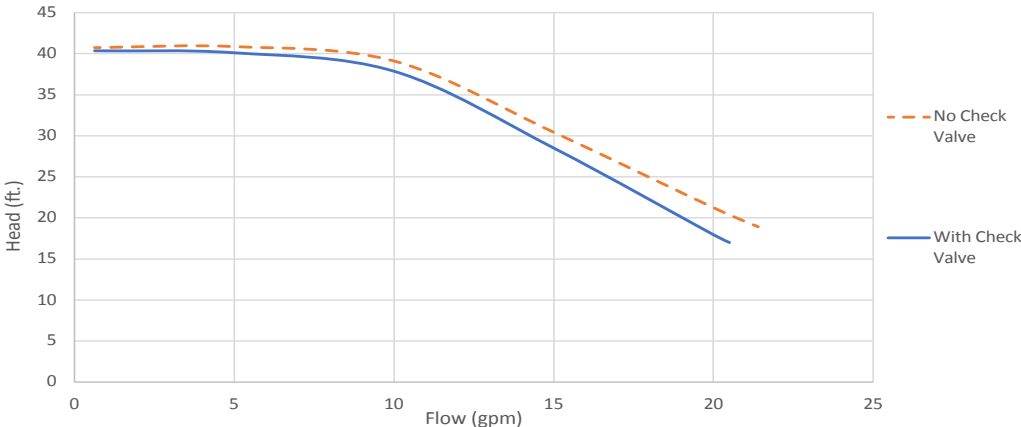

ClimateMaster works continually to improve its products. As a result, the design and specifications of each product at the time of order may be changed without notice and may not be as described herein. Please contact ClimateMaster's Customer Service Department at 800-299-9747 for specific information on the current design and specifications. Statements and other information contained herein are not express warranties and do not form the basis of any bargain between the parties, but are merely ClimateMaster's opinion or commendation of its products. The latest version of this document is available at www.climatemaster.com. Engineered and assembled in the USA. © ClimateMaster, Inc. All Rights Reserved 2024

Antifreeze Correction Table

Models:
SE
024-072

EWT (°F)	Antifreeze Type	Antifreeze %	Cooling			Heating		WPD
			Total Cap	Sensible Cap	Watts	Total Cap	Watts	
90	Water	0%	1.000	1.000	1.000	1.000	1.000	1.000
	Ethanol	5%	0.998	0.998	1.002	0.996	0.999	1.025
		10%	0.996	0.996	1.003	0.991	0.997	1.048
		15%	0.994	0.994	1.005	0.987	0.996	1.098
		20%	0.991	0.991	1.006	0.982	0.994	1.142
		25%	0.986	0.986	1.009	0.972	0.991	1.207
		30%	0.981	0.981	1.012	0.962	0.988	1.265
		35%	0.977	0.977	1.015	0.953	0.985	1.312
		40%	0.972	0.972	1.018	0.943	0.982	1.370
		45%	0.966	0.966	1.023	0.931	0.978	1.431
		50%	0.959	0.959	1.027	0.918	0.974	1.494
	Ethylene Glycol	5%	0.998	0.998	1.002	0.996	0.999	1.021
		10%	0.996	0.996	1.003	0.991	0.997	1.040
		15%	0.994	0.994	1.004	0.987	0.996	1.079
		20%	0.991	0.991	1.005	0.982	0.995	1.114
		25%	0.988	0.988	1.008	0.976	0.993	1.146
		30%	0.985	0.985	1.010	0.969	0.990	1.175
		35%	0.982	0.982	1.012	0.963	0.988	1.208
		40%	0.979	0.979	1.014	0.956	0.986	1.243
		45%	0.976	0.976	1.016	0.950	0.984	1.278
		50%	0.972	0.972	1.018	0.943	0.982	1.314
	Methanol	5%	0.997	0.997	1.002	0.993	0.998	1.039
		10%	0.993	0.993	1.004	0.986	0.996	1.075
		15%	0.990	0.990	1.007	0.979	0.994	1.116
		20%	0.986	0.986	1.009	0.972	0.991	1.154
		25%	0.982	0.982	1.012	0.964	0.989	1.189
		30%	0.978	0.978	1.014	0.955	0.986	1.221
		35%	0.974	0.974	1.017	0.947	0.984	1.267
		40%	0.970	0.970	1.020	0.939	0.981	1.310
		45%	0.966	0.966	1.023	0.930	0.978	1.353
		50%	0.961	0.961	1.026	0.920	0.975	1.398
	Propylene Glycol	5%	0.995	0.995	1.003	0.990	0.997	1.065
		10%	0.990	0.990	1.006	0.980	0.994	1.119
		15%	0.986	0.986	1.009	0.971	0.991	1.152
		20%	0.981	0.981	1.012	0.962	0.988	1.182
		25%	0.978	0.978	1.014	0.956	0.986	1.227
		30%	0.975	0.975	1.016	0.950	0.984	1.267
		35%	0.972	0.972	1.018	0.944	0.982	1.312
		40%	0.969	0.969	1.020	0.938	0.980	1.356
		45%	0.965	0.965	1.023	0.929	0.977	1.402
		50%	0.960	0.960	1.026	0.919	0.974	1.450

Table continued on next page

Antifreeze Correction Table

Models:
SE
024-072

Table continued from previous page

EWT (°F)	Antifreeze Type	Antifreeze %	Cooling			Heating		WPD
			Total Cap	Sensible Cap	Watts	Total Cap	Watts	
30	Water	0%	1.000	1.000	1.000	1.000	1.000	1.000
	Ethanol	5%	0.991	0.991	1.006	0.981	0.994	1.140
		10%	0.981	0.981	1.012	0.961	0.988	1.242
		15%	0.973	0.973	1.018	0.944	0.983	1.295
		20%	0.964	0.964	1.024	0.927	0.977	1.343
		25%	0.959	0.959	1.028	0.917	0.974	1.363
		30%	0.954	0.954	1.031	0.907	0.970	1.383
		35%	0.949	0.949	1.035	0.897	0.967	1.468
		40%	0.944	0.944	1.038	0.887	0.964	1.523
		45%	0.940	0.940	1.041	0.880	0.962	1.580
	50%	0.936	0.936	1.043	0.872	0.959	1.639	
	Ethylene Glycol	5%	0.997	0.997	1.002	0.993	0.998	1.040
		10%	0.993	0.993	1.004	0.986	0.996	1.075
		15%	0.990	0.990	1.006	0.980	0.994	1.122
		20%	0.987	0.987	1.008	0.973	0.992	1.163
		25%	0.983	0.983	1.011	0.966	0.990	1.195
		30%	0.979	0.979	1.013	0.958	0.987	1.225
		35%	0.976	0.976	1.016	0.951	0.985	1.279
		40%	0.972	0.972	1.018	0.943	0.982	1.324
		45%	0.969	0.969	1.021	0.937	0.980	1.371
	50%	0.966	0.966	1.023	0.930	0.978	1.419	
	Methanol	5%	0.995	0.995	1.004	0.989	0.997	1.069
		10%	0.989	0.989	1.007	0.978	0.993	1.127
		15%	0.984	0.984	1.011	0.968	0.990	1.164
		20%	0.979	0.979	1.014	0.957	0.986	1.197
		25%	0.975	0.975	1.017	0.949	0.984	1.216
		30%	0.971	0.971	1.019	0.941	0.981	1.235
		35%	0.967	0.967	1.022	0.933	0.979	1.286
		40%	0.963	0.963	1.025	0.924	0.976	1.323
		45%	0.959	0.959	1.028	0.917	0.974	1.360
	50%	0.955	0.955	1.030	0.910	0.971	1.399	
	Propylene Glycol	5%	0.995	0.995	1.004	0.989	0.997	1.071
		10%	0.989	0.989	1.007	0.978	0.993	1.130
		15%	0.985	0.985	1.010	0.968	0.990	1.206
		20%	0.980	0.980	1.013	0.958	0.987	1.270
		25%	0.974	0.974	1.017	0.947	0.983	1.359
		30%	0.968	0.968	1.021	0.935	0.979	1.433
		35%	0.963	0.963	1.025	0.924	0.976	1.522
		40%	0.957	0.957	1.029	0.913	0.972	1.614
		45%	0.949	0.949	1.034	0.898	0.967	1.712
	50%	0.941	0.941	1.039	0.882	0.962	1.816	

ClimateMaster works continually to improve its products. As a result, the design and specifications of each product at the time of order may be changed without notice and may not be as described herein. Please contact ClimateMaster's Customer Service Department at 800-299-9747 for specific information on the current design and specifications. Statements and other information contained herein are not express warranties and do not form the basis of any bargain between the parties, but are merely ClimateMaster's opinion or commendation of its products. The latest version of this document is available at www.climatemaster.com. Engineered and assembled in the USA. © ClimateMaster, Inc. All Rights Reserved 2024

Water Pressure Drop Adder for Options: Correction Tables

Models:
SE
024-072

System Pressure Drop Valve

Model	GPM	Low System Pressure Drop Valve (Adders)					High System Pressure Drop Valve (Adders)				
		CV	Close Off	MOPD	PSI	FT	CV	Close Off	MOPD	PSI	FT
SE024	3	4.7	200	30	0.41	0.94	4.7	200	30	0.41	0.94
	4.5				0.92	2.12				0.92	2.12
	6				1.63	3.76				1.63	3.76
SE036	4.5	7.4	200	30	0.37	0.85	4.7	200	30	0.92	2.12
	6.8				0.84	1.95				2.09	4.84
	9				1.48	3.42				3.67	8.47
SE048	6	10	200	30	0.36	0.83	4.7	200	30	1.63	3.76
	9				0.81	1.87				3.67	8.47
	12				1.44	3.33				6.52	15.06
SE060	7.5	19	200	30	0.16	0.36	7.4	200	30	1.03	2.37
	11.3				0.35	0.82				2.33	5.39
	15				0.62	1.44				4.11	9.49
SE072	8.5	19	200	30	0.20	0.46	7.4	200	30	1.32	3.05
	12.8				0.45	1.05				2.99	6.91
	17				0.80	1.85				5.28	12.19

ClimateMaster works continually to improve its products. As a result, the design and specifications of each product at the time of order may be changed without notice and may not be as described herein. Please contact ClimateMaster's Customer Service Department at 800-299-9747 for specific information on the current design and specifications. Statements and other information contained herein are not express warranties and do not form the basis of any bargain between the parties, but are merely ClimateMaster's opinion or commendation of its products. The latest version of this document is available at www.climatemaster.com. Engineered and assembled in the USA. © ClimateMaster, Inc. All Rights Reserved 2024

Tranquility (SE) Series

Model (SE)	024	036	048	060	072
Compressor (1 each)	Scroll				
Factory Charge HFC/HFO-454B - (oz.)	34	43	59	102	109
Refrigerant Leak Detection System	O	O	O	R	R
Number of Sensors	2	2	2	2	2
Water Connection Size					
Swivel	1"	1"	1"	1"	1"
System Water Volume (gallons) ¹	0.323	0.738	0.890	0.939	0.939
Vertical					
Filter Standard - 2" Throwaway	28 x 24	28 x 29.5	32 x 29.5	36 x 29.5	36 x 29.5
Weight - Operating (lbs.)	298	359	448	475	475
Weight - Packaged (lbs.)	208	369	458	485	485
Horizontal					
Filter Standard - 2" Throwaway	2 - 18 x 18	1 - 12 x 20 1 - 20 x 25	1 - 18 x 20 1 - 20 x 24	2 - 20 x 24	2 - 20 x 24
Weight - Operating (lbs.)	298	359	448	475	475
Weight - Packaged (lbs.)	308	369	458	485	485
Downflow					
Filter Standard - 2" Throwaway	28 x 24	28 x 29.5	32 x 29.5	36 x 29.5	36 x 29.5
Weight - Operating (lbs.)	298	359	448	475	475
Weight - Packaged (lbs.)	308	369	458	485	485
Hot Water Generator					
Swivel - Residential Class	1"	1"	1"	1"	1"
Weight - HWG Adder (lbs.)	+15	+15	+15	+15	+15

Notes:

- All dimensions displayed above are in inches unless otherwise marked.
 - All units have TXV expansion device and ½-inch and ¾-inch electrical knockouts.
 - The Stainless Steel Condensate Drain Connection is ¾-inch MPT.
 - FPT=Female Pipe Thread
 - O = Optional, R = Required
1. Volume without water options.

Unit Maximum Water Working Pressure

Options	Max Pressure PSIG [kPa]
Base Unit	300 [2,068]
Internal Modulating Valve	300 [2,068]

Horizontal Dimensional Data

Models:
SE
024-072

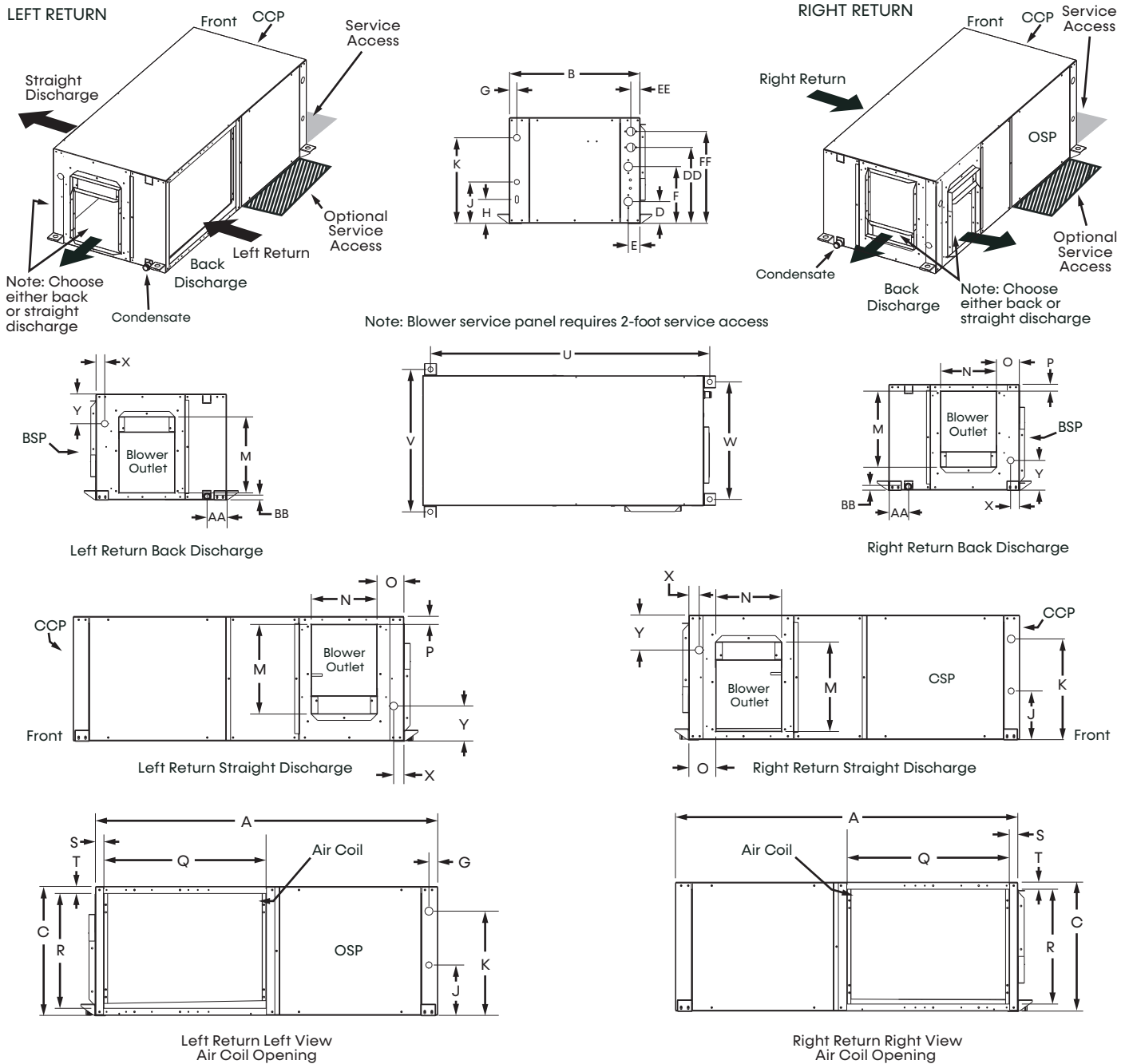

Notes:

1. While clear access to all removable panels is not required, installer should take care to comply with all building codes and allow adequate clearance for future field service.
2. Units come standard with air filter rails. For duct connections, order optional filter frames. See product options decoder for details. You can convert filter rails in the field with an accessory air filter frame kit. Please see the accessory submittal for details.
3. Discharge flange and hanger brackets are factory installed.
4. Condensate connection is 3/4-inch MPT.
5. Blower service panel requires 2-foot service access.
6. Blower service access is through back panel on straight discharge units or through panel opposite air coil on back discharge units.
7. Water connections for optional hot water generator are 1-inch swivels.
8. OSP are removable panels that provide additional access to the units interior. Clear access to OSP panels is not required and they are not to be used in place of the mandatory CCP and BSP panels.

Legend:

- CCP = Control/Compressor Access
- BSP = Blower Service Panel
- OSP = Optional Service Panel (not required)

ClimateMaster works continually to improve its products. As a result, the design and specifications of each product at the time of order may be changed without notice and may not be as described herein. Please contact ClimateMaster's Customer Service Department at 800-299-9747 for specific information on the current design and specifications. Statements and other information contained herein are not express warranties and do not form the basis of any bargain between the parties, but are merely ClimateMaster's opinion or commendation of its products. The latest version of this document is available at www.climatemaster.com. Engineered and assembled in the USA. © ClimateMaster, Inc. All Rights Reserved 2024

Horizontal Service Access

Models:
SE
024-072

Left Return Back Discharge

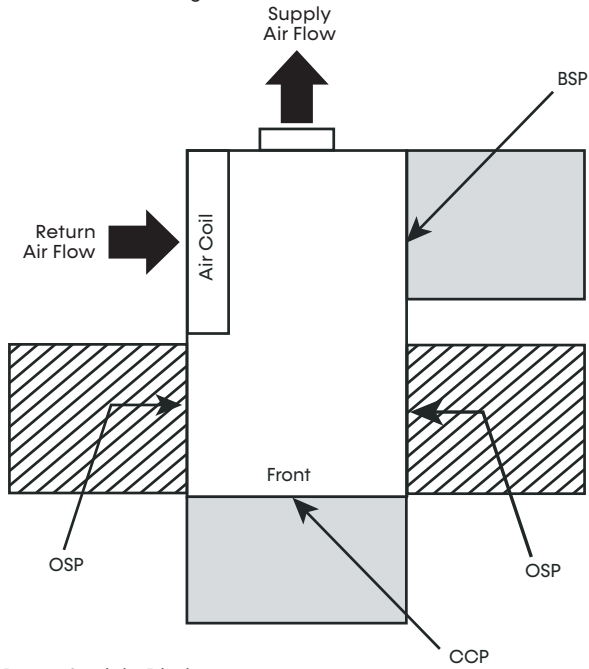

Right Return Back Discharge

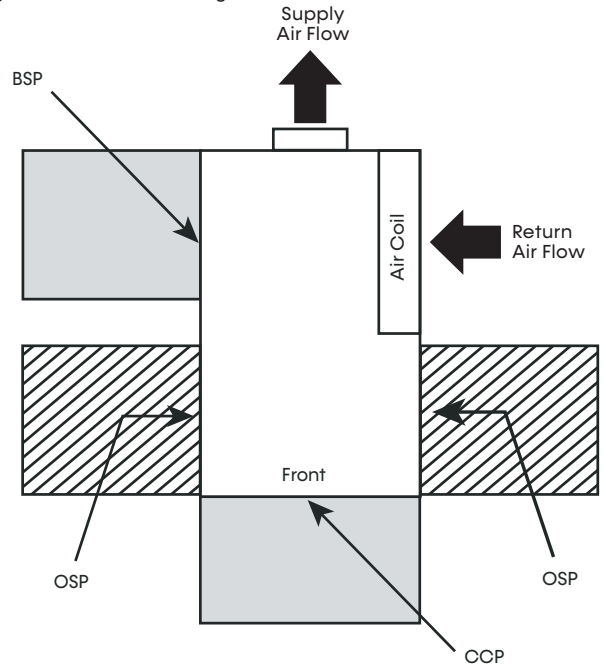

Left Return Straight Discharge

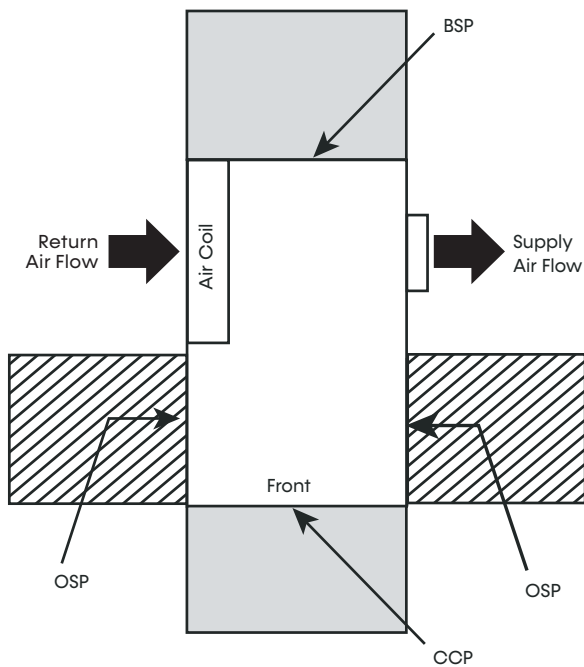

Right Return Straight Discharge

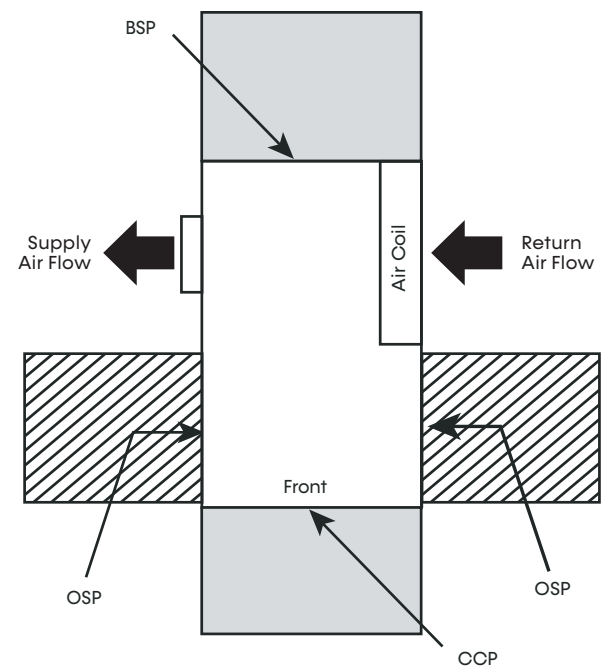

Notes:

1. While clear access to all removable panels is not required, installer should take care to comply with all building codes and allow adequate clearance for future field service.
2. CCP and BSP requires 2-feet of service access.
3. Blower service access is through back panel on straight discharge units or through panel opposite air coil on back discharge units.
4. OSP are removable panels that provide additional access to the units interior. Clear access to OSP panels is not required and they are not to be used in place of the mandatory CCP and BSP panels.

 = Mandatory Service Access 2-foot (61 cm)

 = Optional Service Access 2-foot (61 cm)

Legend:

- CCP = Control/Compressor Access
- BSP = Blower Service Panel
- OSP = Optional Service Panel (not required)

ClimateMaster works continually to improve its products. As a result, the design and specifications of each product at the time of order may be changed without notice and may not be as described herein. Please contact ClimateMaster's Customer Service Department at 800-299-9747 for specific information on the current design and specifications. Statements and other information contained herein are not express warranties and do not form the basis of any bargain between the parties, but are merely ClimateMaster's opinion or commendation of its products. The latest version of this document is available at www.climatemaster.com. Engineered and assembled in the USA. © ClimateMaster, Inc. All Rights Reserved 2024

Vertical Upflow Dimensional Data

Models:
SE
024-072

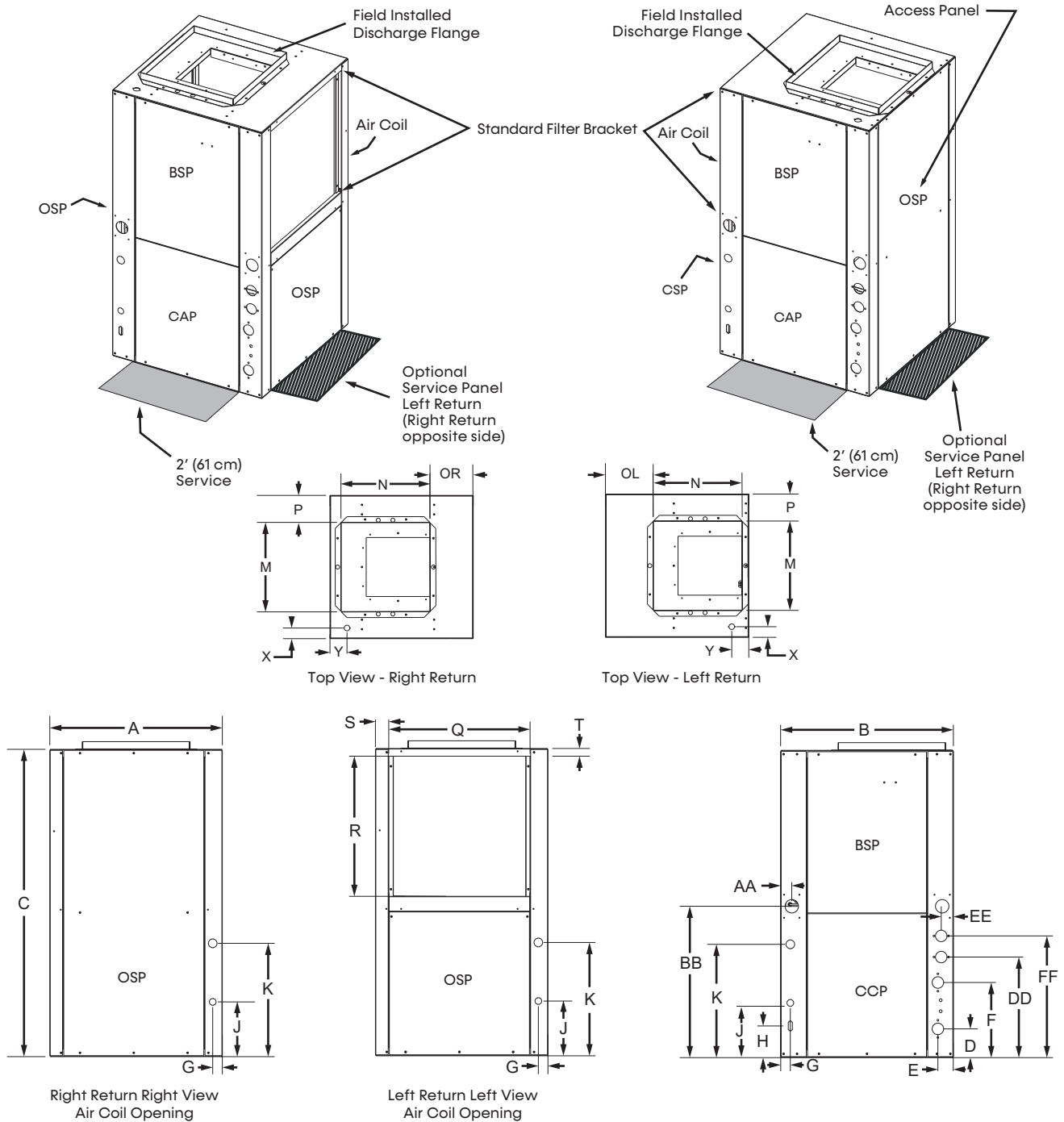

Notes:

1. While clear access to all removable panels is not required, installer should take care to comply with all building codes and allow adequate clearance for future field service.
2. Front and Side access is preferred for service access. However, all components may be serviced from the front access panel if side access is not available.
3. Discharge flange is field installed.
4. Condensate Connection is 3/4-inch MPT.
5. Water connections for optional hot water generator are 1-inch swivels.
6. Units come standard with air filter rails. For duct connections, optional filter frames should be ordered. See product options decoder for details. Filter rails can be converted in the field with an accessory air filter frame kit. Please see the accessory submittal for details.

Legend:
 CCP = Control/Compressor Access
 BSP = Blower Service Panel
 OSP = Optional Service Panel (not required)

ClimateMaster works continually to improve its products. As a result, the design and specifications of each product at the time of order may be changed without notice and may not be as described herein. Please contact ClimateMaster's Customer Service Department at 800-299-9747 for specific information on the current design and specifications. Statements and other information contained herein are not express warranties and do not form the basis of any bargain between the parties, but are merely ClimateMaster's opinion or commendation of its products. The latest version of this document is available at www.climatemaster.com. Engineered and assembled in the USA. © ClimateMaster, Inc. All Rights Reserved 2024

Vertical Downflow Dimensional Data

Models:
SE
024-072

Left Downflow

Right Downflow

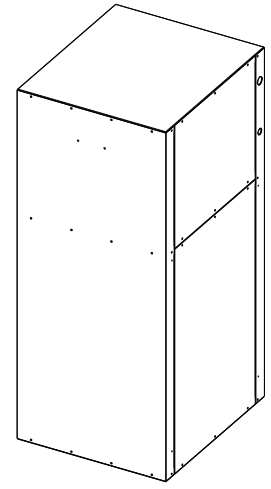
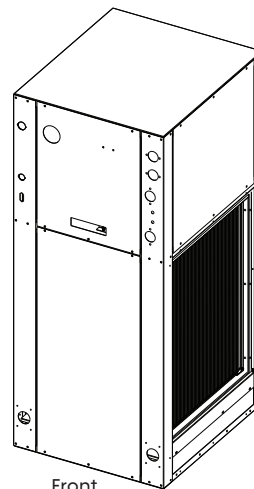
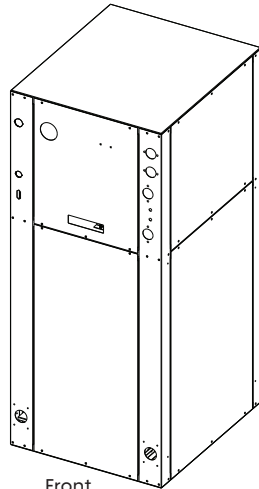
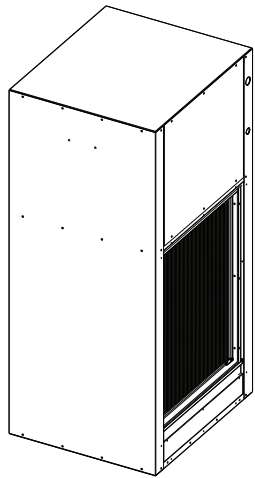

ISO Back

Front

Front

ISO Back

Left

Right

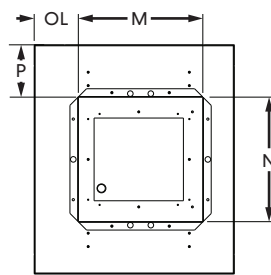
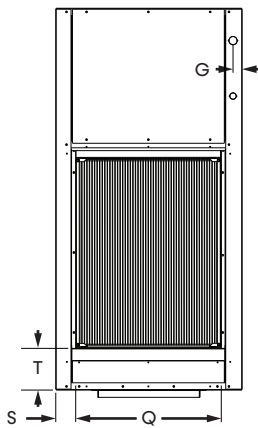

Front

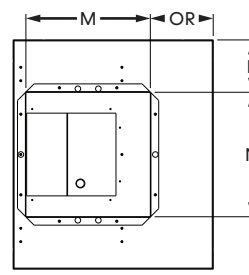

Bottom

Bottom

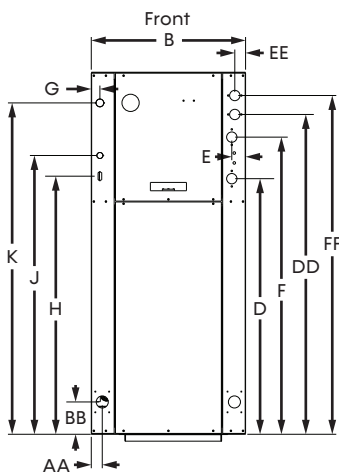
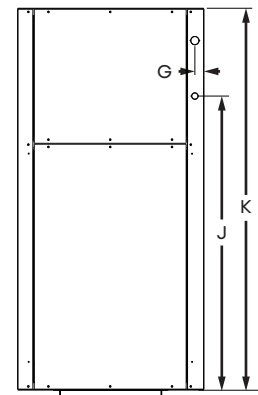

Right

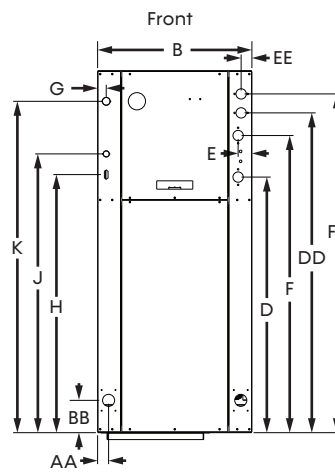
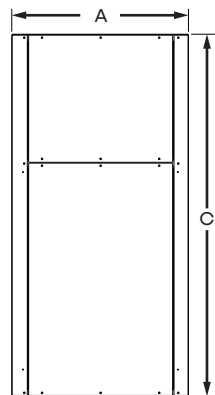

Left

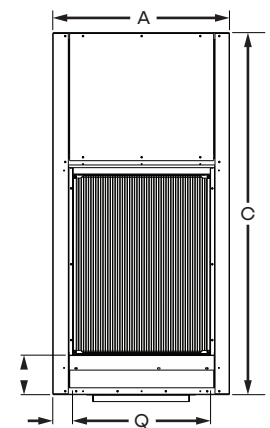

ClimateMaster works continually to improve its products. As a result, the design and specifications of each product at the time of order may be changed without notice and may not be as described herein. Please contact ClimateMaster's Customer Service Department at 800-299-9747 for specific information on the current design and specifications. Statements and other information contained herein are not express warranties and do not form the basis of any bargain between the parties, but are merely ClimateMaster's opinion or commendation of its products. The latest version of this document is available at www.climatemaster.com. Engineered and assembled in the USA. © ClimateMaster, Inc. All Rights Reserved 2024

Vertical Service Access

Models:
SE
024-072

Left Return

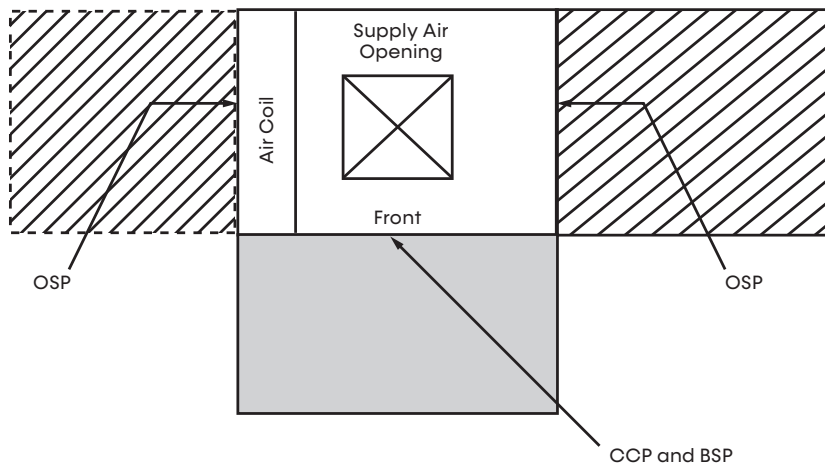

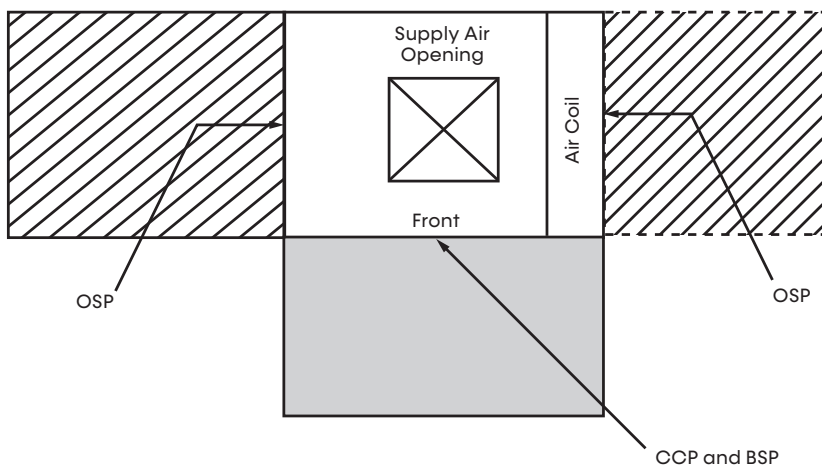

Right Return



Notes:

1. While clear access to all removable panels is not required, installer should take care to comply with all building codes and allow adequate clearance for future field service.
2. Front and side access is preferred for service access. However, all components may be serviced from the front access panel if side access is not available.
3. OSP are removable panels that provide additional access to the units interior. Clear access to OSP panels is not required and they are not to be used in place of the mandatory CCP and BSP panels.
4. Top supply air is shown, the same clearances apply to bottom supply air units.

-  = Mandatory Service Access 2-foot (61 cm)
-  = Optional Service Access 2-foot (61 cm)

Legend:

- CCP = Control/Compressor Access
- BSP = Blower Service Panel
- OSP = Optional Service Panel (not required)

Dimensional Data

Models:
SE
024-072

Cabinet Dimensions (inch)

Model	Cabinet Config	Depth/Length	Width	Height
		A	B	C
SE024	H	62.2	22.4	19.3
	V	25.6	22.4	48.5
	D	25.6	22.4	52.4
SE036	H	71.2	25.4	21.3
	V	30.6	25.4	50.5
	D	30.6	25.4	54.3
SE048	H	76.2	25.4	21.3
	V	30.6	25.4	54.5
	D	30.6	25.4	58.3
SE060-SE072	H	81.2	25.4	21.3
	V	30.6	25.4	58.5
	D	30.6	25.4	62.3

Electrical Knockouts (inch)

Model	Cabinet Config	H	Low Voltage	High Voltage	G
			J KO 1/2"	K KO 3/4"	
SE024	H	4.1	3.6	8.6	1.3
	V	4.1	3.6	8.6	1.3
	D	37.4	40.4	47.9	1.3
SE036	H	4.1	3.6	8.6	1.3
	V	4.1	3.6	8.6	1.3
	D	37.4	40.3	50.0	1.3
SE048	H	4.1	3.6	8.6	1.3
	V	4.1	3.6	8.6	1.3
	D	41.3	48.4	54.0	1.3
SE060-SE072	H	4.1	3.6	8.6	1.3
	V	4.1	3.6	8.6	1.3
	D	45.4	48.4	58.1	1.3

Shipping Weights and Water Connections (inch)

Model	Cabinet Config	Shipping Dimensions			Water Connections										Condensate Drain Pan		
		Depth/Length	Width	Height	Water In		Water Out		Water In/Out		HWG In		HWG Out		AA	BB	Condensate Drain Pan Fitting ³
		A	B	C	D	E	F	E	Com ¹	Res ²	DD	EE	FF	EE			
SE024	H	67.5	28.4	23.7	3.9	1.7	8.4	1.7	3/4"	3/4"	13.9	1.6	16.9	1.6	3.3	1.5	3/4" FPT
	V	28.0	31.0	52.9	3.9	1.6	8.4	1.6	3/4"	3/4"	13.9	1.6	16.9	1.6	1.4	20.0	3/4" FPT
	D	28.0	31.0	56.8	37.0	2.0	43.0	2.0	3/4"	3/4"	46.4	1.6	49.1	1.6	1.6	4.7	3/4" FPT
SE036	H	76.5	31.4	25.7	3.9	2.0	8.4	2.0	3/4"	3/4"	15.6	1.6	18.9	1.6	3.3	3.4	3/4" FPT
	V	31.0	36.0	54.9	3.9	2.0	8.4	2.0	3/4"	3/4"	15.6	1.6	18.9	1.6	2.0	22.3	3/4" FPT
	D	31.0	36.0	58.6	37.0	2.0	44.3	2.0	3/4"	3/4"	49.0	1.6	51.8	1.6	1.6	4.7	3/4" FPT
SE048	H	81.5	31.4	25.7	3.9	2.0	8.4	2.0	1"	1"	15.6	1.6	18.9	1.6	3.3	3.4	3/4" FPT
	V	31.0	36.0	58.9	3.9	2.0	8.4	2.0	1"	1"	15.6	1.6	18.9	1.6	2.0	22.3	3/4" FPT
	D	31.0	36.0	62.6	41.0	2.0	48.3	2.0	1"	1"	53.0	1.6	55.7	1.6	1.6	4.7	3/4" FPT
SE060-SE072	H	86.5	31.4	25.7	3.9	2.0	8.4	2.0	1"	1"	15.6	1.6	18.9	1.6	3.3	3.4	3/4" FPT
	V	31.0	36.0	62.9	3.9	2.0	8.4	2.0	1"	1"	15.6	1.6	18.9	1.6	2.0	21.7	3/4" FPT
	D	31.0	36.0	66.6	45.0	2.0	52.3	2.0	1"	1"	56.9	1.6	59.7	1.6	1.6	4.7	3/4" FPT

Notes:

- Commercial water connections are Female Pipe Thread (FPT) fittings
- Residential water connections are 1-inch swivel connections
- See PDF drawings for reference

Dimensional Data

Models:
SE
024-072

Discharge and Return Connections (inch)

Model	Cabinet Config	Discharge Connection Duct Flange Installed					Return Connection Using Return Air Opening			
		Supply Height	Supply Width	OL (Left Return)	OR (Right Return)	P	Return Width	Return Height	S	T
		M	N				Q	R		
SE024	H	15.4	12.4	3.8	3.8	2.0	32.1	17.3	4.8	1.0
	V	13.9	13.9	6.8	6.7	5.7	21.2	26.8	2.3	1.0
	D	13.9	13.9	4.9	2.8	5.8	21.2	27.3	2.4	6.0
SE036	H	18.9	17.4	2.9	2.9	1.0	36.0	19.3	2.8	1.0
	V	17.9	17.9	2.0	5.3	6.2	26.1	26.1	2.3	1.0
	D	17.9	17.9	5.4	3.0	6.2	26.1	26.0	2.2	6.0
SE048	H	18.9	17.4	3.0	3.0	1.0	41.0	19.3	2.8	1.0
	V	17.9	17.9	3.0	5.3	6.2	26.1	30.2	2.3	1.0
	D	17.9	17.9	5.4	3.0	6.2	26.1	30.4	2.2	5.7
SE060-SE072	H	18.9	17.4	3.0	3.0	1.0	46.0	19.3	2.8	1.0
	V	17.9	17.9	3.0	5.3	6.2	26.1	34.7	2.3	1.0
	D	17.9	17.9	5.4	3.0	6.2	26.1	36.0	2.2	5.2

Corner Weights (lb)

Model	Left - Front	Right - Front	Left - Back	Right/Back
SE024	68.0	56.0	42.0	42.0
SE036	76.0	63.0	47.0	47.0
SE048	98.0	81.0	60.0	60.0
SE060-SE072	103.0	85.0	63.0	63.0

Hanger Dimensions (inch)

Model	Cabinet Config	Unit Hanger Detail		
		U	V	W
SE024	H	48.4	24.6	20.3
SE036	H	53.3	24.6	23.3
SE048	H	68.0	27.6	23.3
SE060-SE072	H	68.0	27.6	23.3

ClimateMaster works continually to improve its products. As a result, the design and specifications of each product at the time of order may be changed without notice and may not be as described herein. Please contact ClimateMaster's Customer Service Department at 800-299-9747 for specific information on the current design and specifications. Statements and other information contained herein are not express warranties and do not form the basis of any bargain between the parties, but are merely ClimateMaster's opinion or commendation of its products. The latest version of this document is available at www.climatemaster.com. Engineered and assembled in the USA. © ClimateMaster, Inc. All Rights Reserved 2024

Dimensional Data

Models:
SE
024-072

Cabinet Dimensions (cm)

Model	Cabinet Config	Depth/Length	Width	Height
		A	B	C
SE024	H	158.0	56.9	49.0
	V	65.0	56.9	123.2
	D	65.0	56.9	133.1
SE036	H	180.8	64.5	54.1
	V	77.7	64.5	128.3
	D	77.7	64.5	137.8
SE048	H	193.5	64.5	54.1
	V	77.7	64.5	138.4
	D	77.7	64.5	148.0
SE060-SE072	H	206.2	64.5	54.1
	V	77.7	64.5	148.6
	D	77.7	64.5	158.1

Electrical Knockouts (cm)

Model	Cabinet Config	H	Low Voltage	High Voltage	G
			J KO 1/2"	K KO 3/4"	
SE024	H	10.4	9.1	21.8	3.2
	V	10.4	9.1	21.8	3.2
	D	95.0	102.7	121.8	3.2
SE036	H	10.4	9.1	21.8	3.2
	V	10.4	9.1	21.8	3.2
	D	95.0	102.3	127.0	3.2
SE048	H	10.4	9.1	21.8	3.2
	V	10.4	9.1	21.8	3.2
	D	104.9	122.9	137.2	3.2
SE060-SE072	H	10.4	9.1	21.8	3.2
	V	10.4	9.1	21.8	3.2
	D	115.3	122.9	147.4	3.2

Shipping Weights and Water Connections (cm)

Model	Cabinet Config	Shipping Dimensions			Water Connections										Condensate Drain Pan		
		Depth/Length A	Width B	Height C	Water In		Water Out		Water In/Out		HWG In		HWG Out		AA	BB	Condensate Drain Pan Fitting ³
					D	E	F	E	Com ¹	Res ²	DD	EE	FF	EE			
SE024	H	171.5	72.1	60.1	9.9	4.3	21.3	4.3	3/4"	3/4"	35.3	4.1	42.9	4.1	8.5	3.8	3/4" FPT
	V	71.1	78.7	134.3	9.9	4.1	21.3	4.1	3/4"	3/4"	35.3	4.1	42.9	4.1	3.6	50.7	3/4" FPT
	D	71.1	78.7	144.3	94.0	5.1	109.3	5.1	3/4"	3/4"	117.9	4.0	124.8	4.1	4.1	11.9	3/4" FPT
SE036	H	194.3	79.7	65.2	9.9	5.0	21.3	5.0	3/4"	3/4"	39.6	4.1	48.0	4.1	8.3	8.6	3/4" FPT
	V	78.7	91.4	139.4	9.9	5.0	21.3	5.0	3/4"	3/4"	39.6	4.1	48.0	4.1	5.0	56.6	3/4" FPT
	D	78.7	91.4	148.9	94.0	5.1	112.4	5.1	3/4"	3/4"	124.5	4.1	131.4	4.1	4.1	11.9	3/4" FPT
SE048	H	207.0	79.7	65.2	9.9	5.0	21.3	5.0	1"	1"	39.6	4.1	48.0	4.1	8.3	8.6	3/4" FPT
	V	78.7	91.4	149.6	9.9	5.0	21.3	5.0	1"	1"	39.6	4.1	48.0	4.1	5.0	56.6	3/4" FPT
	D	78.7	91.4	159.1	104.0	5.0	122.7	5.0	1"	1"	134.5	4.1	141.4	4.1	4.1	11.9	3/4" FPT
SE060-SE072	H	219.7	79.7	65.2	9.9	5.0	21.3	5.0	1"	1"	39.6	4.1	48.0	4.1	8.3	8.6	3/4" FPT
	V	78.7	91.4	159.7	9.9	5.0	21.3	5.0	1"	1"	39.6	4.1	48.0	4.1	5.0	55.1	3/4" FPT
	D	78.7	91.4	169.2	114.4	5.0	132.8	5.0	1"	1"	144.6	4.1	151.6	4.1	4.1	11.9	3/4" FPT

Notes:

- Commercial water connections are Female Pipe Thread (FPT) fittings
- Residential water connections are 1-inch swivel connections
- See PDF drawings for reference

Dimensional Data

Models:
SE
024-072

Discharge and Return Connections (cm)

Model	Cabinet Config	Discharge Connection Duct Flange Installed					Return Connection Using Return Air Opening			
		Supply Height	Supply Width	OL (Left Return)	OR (Right Return)	P	Return Width	Return Height	S	T
		M	N				Q	R		
SE024	H	39.1	31.5	9.5	9.5	5.0	81.5	43.9	12.2	2.5
	V	35.3	35.3	17.3	17.0	14.5	53.8	68.1	5.8	2.5
	D	35.3	35.3	12.4	7.1	14.7	53.8	69.3	6.1	15.2
SE036	H	48.0	44.2	7.5	7.5	2.5	91.4	49.0	7.1	2.5
	V	45.5	45.5	5.1	13.5	15.7	66.3	66.3	5.8	2.5
	D	45.5	45.5	13.7	7.6	15.7	66.3	66.0	5.6	15.2
SE048	H	48.0	44.2	7.6	7.6	2.5	104.1	49.0	7.1	2.5
	V	45.5	45.5	7.6	13.5	15.7	66.3	76.7	5.8	2.5
	D	45.5	45.5	13.7	7.6	15.7	66.3	77.2	5.6	14.5
SE060-SE072	H	48.0	44.2	7.6	7.6	2.5	116.8	49.0	7.1	2.5
	V	45.5	45.5	7.6	13.5	15.7	66.3	88.1	5.8	2.5
	D	45.5	45.5	13.7	7.6	15.7	66.3	91.4	5.6	13.2

Corner Weights (kg)

Model	Left - Front	Right - Front	Left - Back	Right/Back
SE024	30.8	25.4	19.1	19.1
SE036	34.5	28.6	21.3	21.3
SE048	44.5	36.7	27.2	27.2
SE060-SE072	46.7	38.6	28.6	28.6

Hanger Dimensions (cm)

Model	Cabinet Config	Unit Hanger Detail		
		U	V	W
SE024	H	122.9	62.5	51.6
SE036	H	135.4	62.5	59.2
SE048	H	172.7	70.1	59.2
SE060-SE072	H	172.7	70.1	59.2

ClimateMaster works continually to improve its products. As a result, the design and specifications of each product at the time of order may be changed without notice and may not be as described herein. Please contact ClimateMaster's Customer Service Department at 800-299-9747 for specific information on the current design and specifications. Statements and other information contained herein are not express warranties and do not form the basis of any bargain between the parties, but are merely ClimateMaster's opinion or commendation of its products. The latest version of this document is available at www.climatemaster.com. Engineered and assembled in the USA. © ClimateMaster, Inc. All Rights Reserved 2024

MINIMUM INSTALLATION AREA

Minimum area where a blower-equipped unit must be installed, and mechanical/natural ventilation is not required

Model	Charge (oz)	Configuration	Minimum Installation Area ft ² (m ²) [A _{min}]			
			Floor	Window	Wall	Ceiling
SE060	102	Vertical	351 (32.61)	195 (18.12)	112 (10.41)	92 (8.55)
		Horizontal	351 (32.61)	209 (19.42)	116 (10.78)	95 (8.83)
SE072	109	Vertical	375 (34.84)	209 (19.42)	120 (11.15)	99 (9.20)
		Horizontal	375 (34.84)	223 (20.72)	124 (11.52)	102 (9.48)

A _{min} =	Minimum area where unit is installed where unit has incorporated airflow
h _{inst} (floor) =	0.0 ft (0.0 m)
h _{inst} (window) =	3.3 ft (1.0 m)
h _{inst} (wall) =	5.9 ft (1.8 m)
h _{inst} (ceiling) =	7.2 ft (2.2 m)

Minimum area and CFM requirements for the conditioned space

Model	Charge (oz)	Minimum CFM [Q _{min}]	
		TA _{min} ft ² (m ²)	Q _{min} (ft ³ /min)
SE060	102	5.2 (0.48)	173 (293.07)
SE072	109	5.6 (0.52)	184 (313.19)

TA _{min} =	Minimum conditioned area for venting leaked refrigerant
Q _{min} =	Minimum ventilation flow rate for conditioned space if space is less than TA _{min}

Minimum area of opening for natural ventilation

Model	Charge (oz)	Anv _{min} in ² (m ²)
SE060	102	135.65 (12.60)
SE072	109	140.23 (13.03)

Anv _{min} =	Minimum natural ventilation area opening
----------------------	--

When the openings for connected rooms or natural ventilation are required, the following conditions shall be applied:

- The area of any openings above 11.8 inches (300 mm) from the floor shall not be considered in determining compliance with Anv_{min}.
- At least 50% of the required opening area Anv_{min} shall be below 7.8 inches (200 mm) from the floor.
- The bottom of the lowest openings shall not be higher than the point of release when the unit is installed and not more than 3.9 inches (100 mm) from the floor.
- Openings are permanent openings which cannot be closed.
 - For openings extending to the floor, the height shall not be less than 0.78 inch (20 mm) above the surface of the floor covering.
- A second higher opening shall be provided. The total size of the second opening shall not be less than 50% of minimum opening area for Anv_{min} and shall be at least 3.3 ft (1.5 m) above the floor.

ACCESSORIES AND OPTIONS

Hot Water Generator

An optional insulated heat reclaiming desuperheater coil of vented double-wall copper construction suitable for potable water shall be provided. The coil, hot water circulating pump, and associated controls shall be factory mounted inside the unit cabinet. Sensors mounted on the compressor discharge line and the potable water inlet shall transmit temperatures to the unit microprocessor where internal logic will determine when hot water generation is feasible. The microprocessor shall cycle the pump periodically during unit operation to sample the DHW tank temperature. The microprocessor shall include multiple temperature set points to select from for hot water generation control.

Cupro-Nickel Heat Exchanger

An optional corrosion resistant CuNi coaxial heat exchanger shall be factory installed in lieu of standard copper construction.

Thermostat (field installed)

An electronic communicating LCD thermostat shall be provided. The thermostat shall offer three stages of heating and two stages of cooling with precise temperature control and have a four-wire connection to the unit. The thermostat shall be capable of manual or automatic change-over operation and shall operate in standard or programmable mode. An integrated humidity control feature shall be included to control a humidifier and/or a dehumidifier. The thermostat shall include a utility demand reduction feature to be initiated by an independent time program or an external input.

The thermostat shall have a comprehensive installation setup menu to include configuration of the unit CFM for each mode of operation and configuration of the water flow rate through the unit, including variation of the water flow rate based on the stage of unit operation.

The thermostat shall display system faults with probable cause and troubleshooting guidance. Comprehensive service diagnostics menus shall display, system inputs, system outputs, configuration settings, Geo source inlet and outlet temperatures, compressor discharge line temperature, liquid line temperature, leaving air temperature, and entering potable water temperature (on units equipped with a Hot Water Generator). The thermostat shall allow for immediate manual control of all DXM2.5 outputs at the thermostat for rapid troubleshooting.

Auxiliary Heater (field installed)

An external, field-installed electric heater shall provide supplemental and/or emergency heating capability when used with the three stage heating thermostat.

Revision History

Models:
SE
024-072

Date	Section	Description
02/19/25	Electrical Data: CV EC Blower Motor	Updated data for size 036 for units with Internal Flow Controller - Standard Head Variable Pump
	Performance Data	Added a note concerning Hot Water Generator Capacity calculation
	Part Load Performance: Correction Tables	Updated correction data for Cooling, Entering Air Heating, and Airflow
	Full Load Performance: Correction Tables	Updated correction data for Cooling, Entering Air Heating, and Airflow
	Dimensional Data	Added shipping dimensions
	All	Added the Wireless Service Tool
	All	Updated the document's section order
01/27/25	Model Nomenclature	Updated Drain Pan/Heat Exchanger and Water/Heat Exchanger options
	Minimum Installation Area	Updated data for non-ventilated installation
	Electrical Data: CV EC Blower Motor	Updated data
09/30/24	Blower Performance: CV EC Standard Unit	Updated the CV EC table
	Dimensional Data	Updated measurements for O
	Vertical Downflow Dimensional Data	Added section
09/16/24	Model Nomenclature	Updated Voltage, Drain Pan/Heat Exchanger, and Water/Heat Exchanger options
	Blower Performance Data	Updated Max ESP for all sizes.
	Electrical Data: CV EC Blower Motor	Aligned available data to offerings. Updated Table Title.
	Physical Data	Updated presentation of HWG weight
	Performance Data	Updated performance data
08/12/24	All	First published



A NIBE GROUP MEMBER

7300 SW 44th St. | Oklahoma City, OK 73179
Phone: 800.299.9747
www.climatemaster.com



RP3001

ClimateMaster works continually to improve its products. As a result, the design and specifications of each product at the time of order may be changed without notice and may not be as described herein. Please contact ClimateMaster's Customer Service Department at 800-299-9747 for specific information on the current design and specifications. Statements and other information contained herein are not express warranties and do not form the basis of any bargain between the parties, but are merely ClimateMaster's opinion or commendation of its products. The latest version of this document is available at www.climatemaster.com. Engineered and assembled in the USA. © ClimateMaster, Inc. All Rights Reserved 2024