



**NIDEC MOTOR CORPORATION**

**PerfectSpeed® Motor  
Troubleshooting Manual**

**Models: 1 Hp,  $\frac{3}{4}$  Hp,  $\frac{1}{2}$  Hp, and  $\frac{1}{3}$  HP**

*Table of Contents*

**About the PerfectSpeed® Motor.....3**

**Important Safety Information.....5**

**Getting Started.....9**

**Basic troubleshooting.....9**

**Check 1 : Diagnosis with UltraCheck-EZ® Diagnostic Tool .....10**

**Check 2 : Electrical Troubleshooting.....13**

**Check 3 : Control Unit Verification.....15**

**Check 4 : Motor Verification.....18**

## **About the PerfectSpeed® Motor**

The PerfectSpeed® Variable Speed Motor is a 4-wire electronically controlled motor. Its two-way communication provides automatic configuration and checking of system settings to ensure the customer better comfort, efficiency, and higher reliability. The PerfectSpeed® motor provides efficient “soft” start-and-stop and automatically adjusts its speed to precisely match humidity and temperature needs. The end result for homeowners is enhanced energy efficiency and home comfort.

### About Nidec Motor Corporation:

Nidec Motor Corporation (NMC) is a leading manufacturer of commercial, industrial, and appliance motors and controls. The NMC product line features a full line of high efficiency motors, large and small, which serve industrial, residential and commercial markets in applications ranging from water treatment, mining, oil and gas and power generation to pool and spa motors, air conditioning condensers, rooftop cooling towers and commercial refrigeration. It also makes motors, controls and switches for automotive and commercial markets. Brands include U.S. Motors®, SR Drives®, Hurst®, Rescue®, ECOTECH-EZ®.

Parent company Nidec Corporation (NYSE: NJ) is the world's leading manufacturer of small precision motors, including motors used in hard disk drives and optical disk drives. The company has extended its focus beyond the information storage motor market to the home appliance and automotive markets, where it sees high future growth potential.

For more information, visit [www.nidec-motor.com](http://www.nidec-motor.com).

**PerfectSpeed®  
Variable Speed Motor Assembly**

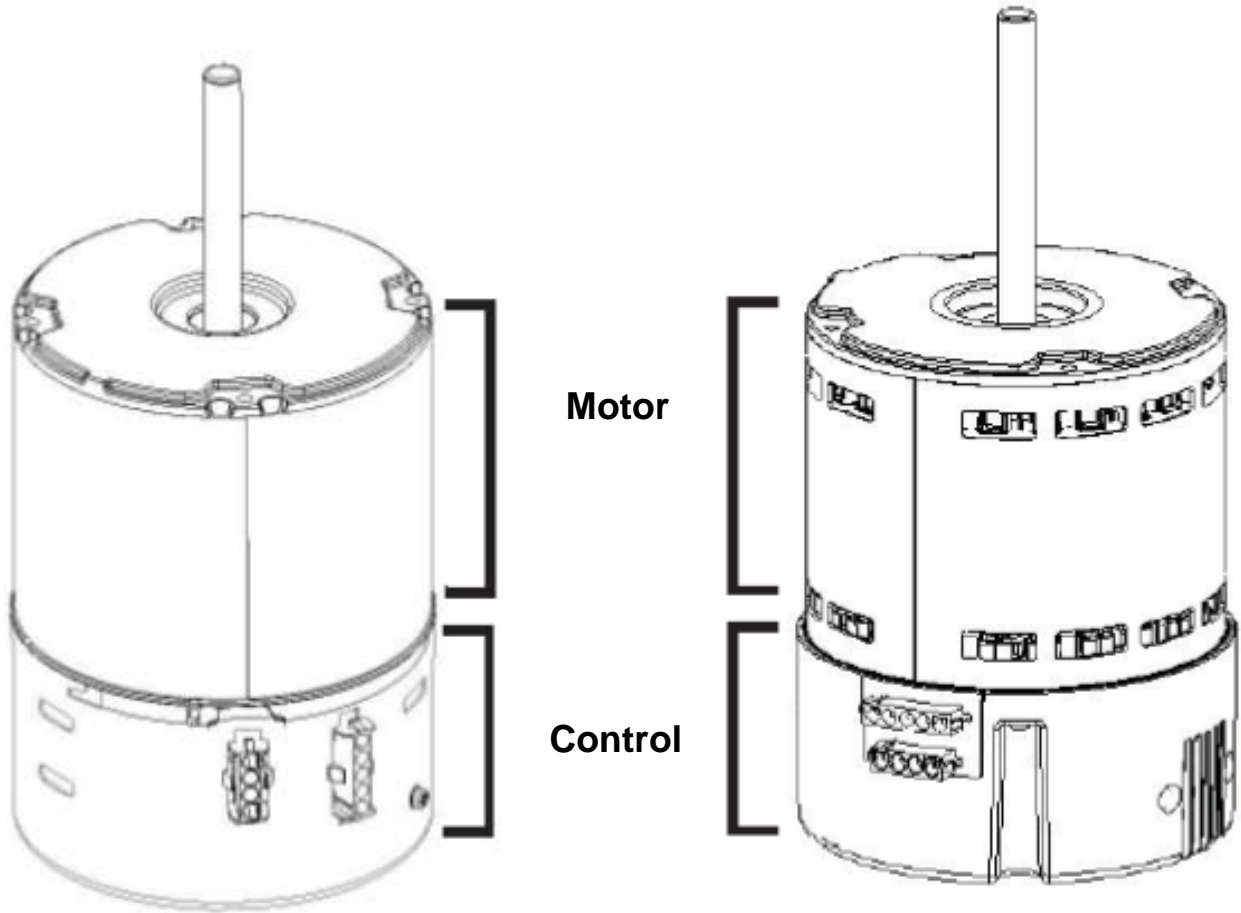

**Generation I**

**Generation II**

# Important Safety Information

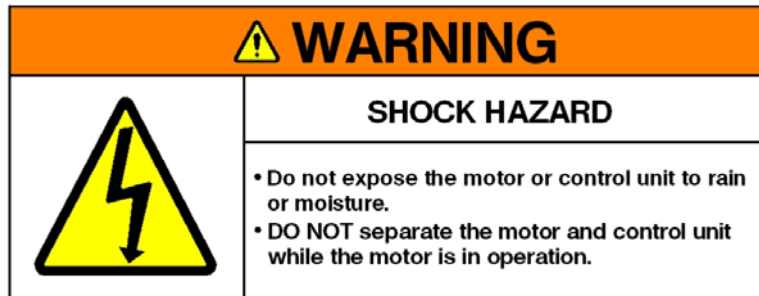



## **WARNING**

- Only trained and qualified professionals familiar with PerfectSpeed® motors should service the motor and control unit.
- Before connecting or disconnecting cables or other electrical connections, verify power is shut off to the system. Failure to comply may cause serious damage to the motor, HVAC system or injury to personnel.
- Because the risk of electric shock, only individuals thoroughly trained in the use of multimeters should conduct voltage tests.
- Never touch the metal contacts on the multimeter during a Test.
- Always check testing equipment for proper operation before Use.
- All aspects of the installation must conform to the applicable requirements of the NEC (National Electric Code), including Article 430 (Motor Circuits and Controllers), as well as all local codes.

**⚠ WARNING** **Safe installation, operation and maintenance must be performed by qualified personnel.** Familiarization with and adherence to the National Electric Code, NFPA (National Fire Protection Association) standards and local codes is required. It is important to observe safety precautions to protect personnel from possible injury. Personnel should be instructed for handling each of the following:

- Insulate all connections carefully to prevent grounding or short circuits. Reinstall all conduit and terminal box covers.
- Voltage to the motor control must be within plus or minus 10% of the nameplate voltage to avoid overheating and loss of performance.
- Make sure the unit is electrically grounded and proper electrical installation wiring and controls are used consistent with local and national electric codes. Refer to “National Electrical Code Handbook ”& NFPA No. 70. Employ qualified electricians. Insulate all connections carefully to prevent grounding or short circuits. Reinstall all conduit and terminal box covers.
- Code requirements differ from state to state. Install equipment in accordance with the applicable codes and ordinances in your area and in accordance with the National Electrical Code. All electrical connections should be made and maintained by a qualified or licensed electrician.
- Make sure there are no unusual noises or vibrations when the motor is running. If noise and vibration are observed, refer to the Troubleshooting section.
- Avoid contact with energized circuits or rotating parts.
- Provide proper safeguards for personnel against rotating parts.

** WARNING** Always disconnect electrical power at the fuse box or circuit breaker before handling electrical connections or performing maintenance on this unit. Allow the motor to come to a complete stop. Double check to make sure power is OFF, and that it cannot be turned on while you are working on the equipment. Wait 2 minutes before handling the Power Cord. This allows the bus capacitors to fully discharge.

** WARNING** A poor electrical connection can overheat and cause terminal and/or terminal board failures. Because of this possibility, wiring harness quick-connect terminals should be examined carefully for any signs of physical deterioration or loose fit to the terminals on the motor terminal board. If there is evidence of loose fit or deterioration, quick-connect terminals should be removed from the wiring harness and the harness wires then connected directly to the motor terminal board wiring terminals. Care must be taken to assure connections are made to the proper terminals and adequate electrical clearances are maintained.

** WARNING** The control on the motor contains potentially hazardous voltage.

## CAUTION

- Safety glasses should be worn to inspect the equipment while it is running or while a mallet or hammer is used, especially if cover plates are removed.

## NOTICE

- Motor and control unit are assembled and calibrated as a set. Mismatching the motor or control unit with other unsuitable parts will drastically affect performance tolerance.
- To prevent permanent damage to the unit, DO NOT apply 240 VAC to the motor with the jumper in positions 1 and 2.
- Do not strike the motor shaft with a hammer or other tool as this may damage the bearings.
- Do not operate the motor without blower wheel attached. Without the blower wheel, the motor will run continuously to a maximum speed and then stop.
- Voltage symbols vary among different multimeters and may be displayed as V ac, AC, V, or a V beneath a wavy line. Select the correct symbol and set the multimeter to the voltage closest to the voltage that is being measured.
- Become familiar with the equipment and read all Instructions thoroughly before installing or working on the equipment.
- The PerfectSpeed® Variable Speed Motor is properly packaged for shipment and storage and should be in a clean, dry indoor area.



## Getting Started

This troubleshooting guide provides field technicians a step by step process for accurately diagnosing and troubleshooting certain problems experienced by Nidec PerfectSpeed® motors. It does not override or replace instructions suggested by the manufacturer of the HVAC system. To prevent misdiagnosis and unneeded repairs, operators should try the steps listed in the Basic Troubleshooting section first. If a problem still exists or there is an ongoing issue after following the steps in the Basic Troubleshooting Section, then go to the Control Unit Diagnostics section for further guidance.

### **Basic Troubleshooting**

#### **Motor isn't spinning or runs abnormally**

- Verify thermostat is issuing call for activity.
- Check circuit breaker for trips or accidental shutoff.
- Verify communication cable and power cord are securely connected to control unit connectors. Inspect for shorts, detached wiring, or loose connections.
- Inspect control unit for broken or loose connectors, moisture, excessive dirt or other damage.

#### **Motor rattles or makes excessive noise**

- Inspect motor and blower for accumulated dirt, internal debris or other signs of damage.
- Inspect blower fan for bent or missing blades, misaligned shaft, or unsecured mounting to shaft.
- Inspect blower housing for cracks, dents, or corrosion.
- Inspect blower housing for secure mounting to system chassis.
- Inspect shaft, verify motor shaft spins freely without effort, by hand, in both directions.

## Check 1: Diagnosis with UltraCheck-EZ® Diagnostic Tool

If the UltraCheck-EZ® diagnostic tool is not available, please proceed to and complete Checks 3 through 4 in order.

**ClimateMaster part number: AULTRACHK**

### NOTICE

Only trained and qualified professionals familiar with PerfectSpeed® motors should service the motor and control unit.

### Connecting the UltraCheck-EZ® Diagnostic Tool

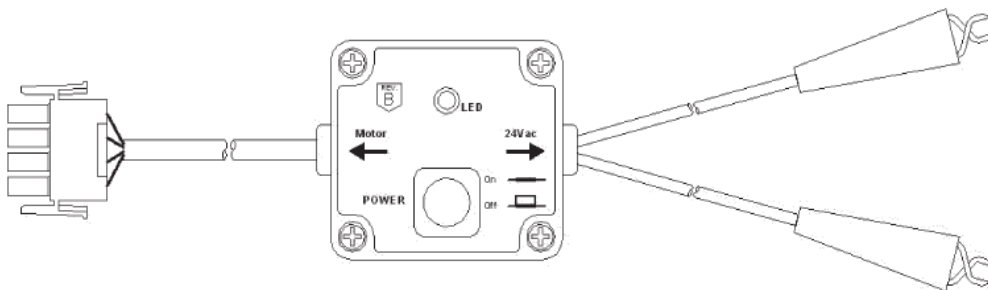

1. Disconnect or turn off AC power to the furnace, air handler, or equipment being serviced.
2. Disconnect the four wire communication cable from the control unit connector [Figure 1].

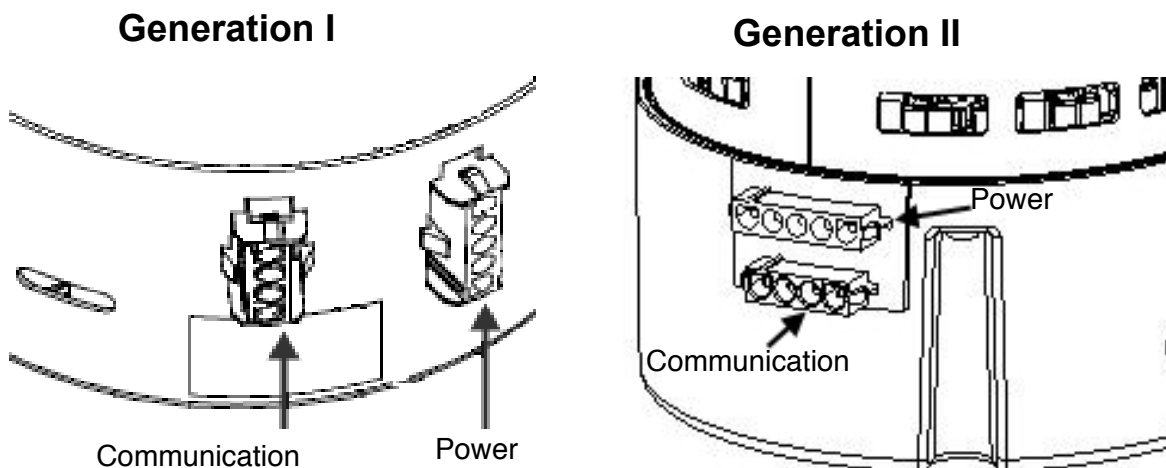

Figure 1

3. Connect the four wire connector of the UltraCheck-EZ® diagnostic tool [Figure 2] to the control unit communication connector [Figure 1].

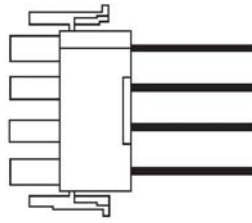

Figure 2

4. Attach one of the alligator clips of the UltraCheck-EZ® diagnostic tool [Figure 3] to a proper ground source.



Figure 3

5. Attach the other alligator clip [Figure 3] to a proper 24 Vac source.

## NOTICE

There is no polarity of the alligator clips.

The UltraCheck-EZ® diagnostic tool is equipped with a non replaceable fuse. **DO NOT** connect the UltraCheck-EZ® diagnostic tool to a power supply over 24 Vac. This will make the UltraCheck-EZ® diagnostic tool inoperable.

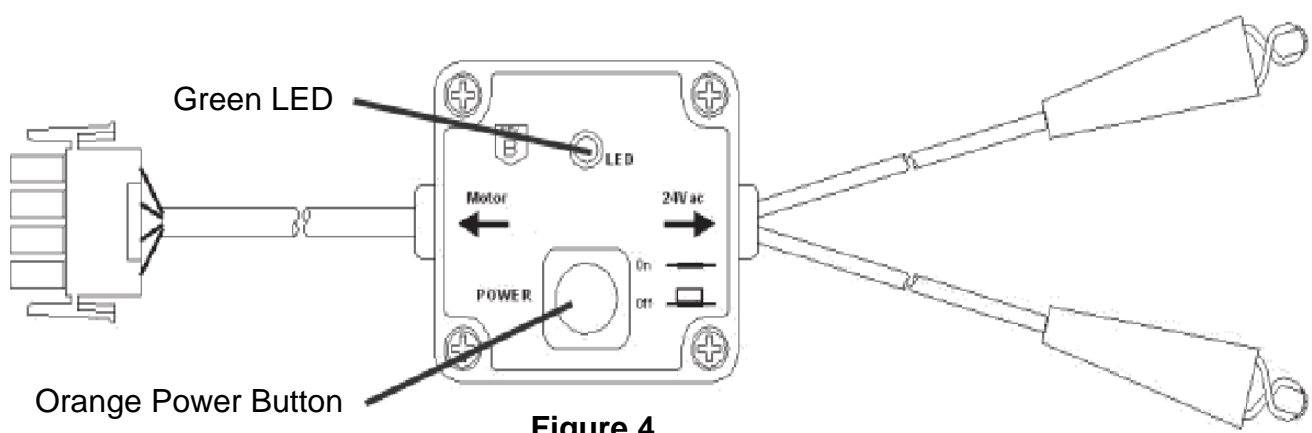

Figure 4

6. Reestablish power to furnace, air handler or equipment being serviced.

## NOTICE

The **orange button** on the UltraCheck-EZ® diagnostic tool sends a signal to the PerfectSpeed® motor to rotate when pressed. There may be a five second delay between the time the button is pushed and the motor begins to rotate. **If the orange button doesn't illuminate when pressed, the UltraCheck-EZ® diagnostic tool is not connected to a 24 Vac supply or is inoperable.**

The **green LED** is an indicating signal that the PerfectSpeed® motor is communicating with the UltraCheck-EZ® diagnostic tool. **If the green LED doesn't blink, the control unit should be replaced.**

- Use the scenarios below to determine needed action. Complete steps 8-11 before proceeding to the next check. Press the orange button [Figure 4] on the UltraCheck-EZ® diagnostic tool and wait five seconds for the blower to spin.

Orange Power Button	Green LED	Motor Blower	Comments
Not Lit	Not Lit	Not Rotating	If button does not illuminate when power button is depressed, verify 24Vac is available at alligator clips. If 24Vac is verified, the UltraCheck-EZ® diagnostic tool is inoperable.
Lit	Blinking	Rotating	Motor and control unit are functioning properly.
Lit	Not Lit	Rotating	Control unit should be replaced.
Lit	Blinking	Not Rotating	Further investigation required. Proceed to Check 4 to verify motor operation.
Lit	Not Lit	Not Rotating	Control unit should be replaced, proceed to Check 4 to verify motor is still operational.

- Press the orange button [Figure 4] again to stop the blower and turn off the UltraCheck-EZ® diagnostic tool.
- Disconnect or turn off AC power to the furnace, air handler, or equipment being serviced.
- Remove both alligator clips [Figure 3] from the 24Vac and ground connections.
- Reconnect the four wire communication connector to the control unit connector [Figure 1].
- Reestablish power to the furnace, air handler or system being serviced.

## Check 2 : Electrical Troubleshooting

1. Disconnect or turn off power to the furnace, air handler, or system being serviced and wait 2 minutes. This allows the capacitors in the control unit to fully discharge.
2. Check the rotation and speed of the blower fan. Determine if the blower fan can spin freely manually, without effort or assisted means. If binding occurs, the motor needs to be replaced.
3. Determine if HVAC system is wired for 120 VAC power, 240 VAC power or 277 VAC power.
  - If system is wired for 120 VAC power, verify a jumper wire is installed between positions 1 and 2 of the power cord connector. On systems wired for 240 VAC or 277 VAC, the jumper wire should be removed [Figure 5].

### NOTICE

Operating the motor at 240 VAC or 277 VAC with jumper wire installed will cause significant damage to the motor.

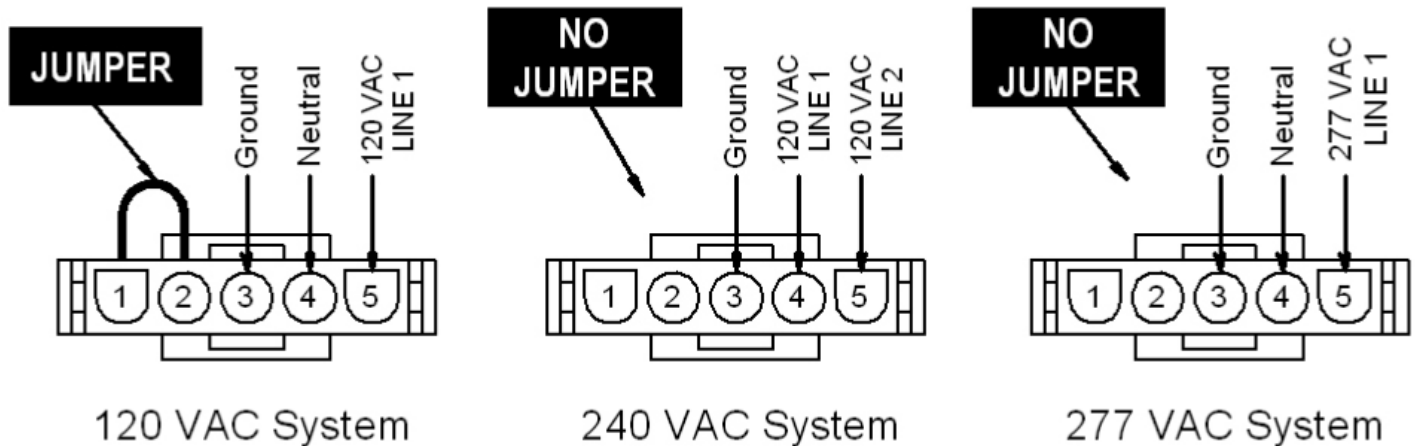

Figure 5

4. Disconnect power cord from connector on control unit. Inspect power cord for bent, damaged or recessed wires and terminals [Figure 1].
  - Contact HVAC manufacturer if power cord contains bent, damaged or recessed wires or terminals.
5. Disconnect four wire communication cable from connector on control unit. Inspect cable for bent, damaged or recessed wires and terminals [Figure 1].
  - Contact HVAC manufacturer if communication cable contains bent, damaged or recessed wires or terminals.
6. Reconnect or turn on power to the furnace, air handler or system being serviced.
7. Check the voltage between position 4 and 5 of the power cord connector [Figure 5].
  - Contact HVAC manufacturer if system is rated for 120 VAC power, and the measured voltage between positions 4 and 5 is not 120 VAC.
  - Contact HVAC manufacturer if system is rated for 240 VAC power, and the measured voltage between positions 4 and 5 is not 240 VAC.
  - Contact HVAC manufacturer if system is rated for 277 VAC power, and the measured voltage between positions 4 and 5 is not 277 VAC.
  - If the measured voltages are correct between positions 4 and 5 for the 120 VAC, 240 VAC or 277 VAC system, go to step 8.



**Figure 6**

8. Check the voltage between positions 1 and 4 of the communication cable connector [Figure 6].
  - Contact HVAC manufacturer if the measured voltage between positions 1 and 4 is not 9-15 V dc.
  - If the measured voltage between positions 1 and 4 is 9-15 V dc, go to step 9.
  - If all electrical checks are okay, go to step 9.
9. Disconnect or turn off AC power to the furnace, air handler, or system being serviced. Wait 2 minutes to allow the capacitors to fully discharge.

Proceed to Check 3.

## Check 3 : Control Unit Verification

### Generation I

1. Disconnect or turn off AC power to the furnace, air handler or system being serviced. Wait 2 minutes to allow the capacitors to fully discharge.

#### Removing Control Unit

2. Loosen two screws securing the motor and control unit together. Twist the control unit and pull away from motor until both units are separated. [Figure 7a].

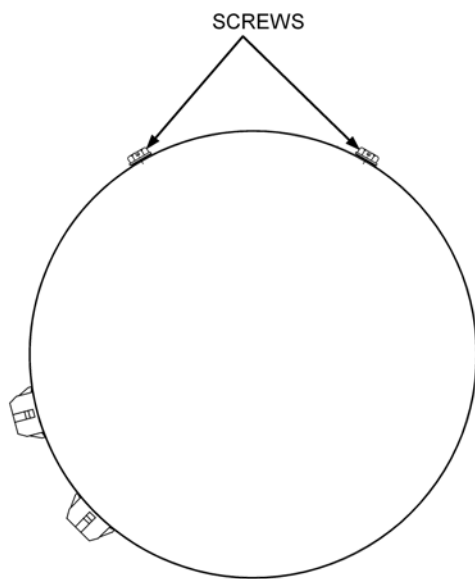

Figure 7a

### Generation II

1. Disconnect or turn off AC power to the furnace, air handler or system being serviced. Wait 2 minutes to allow the capacitors to fully discharge.

#### Removing Control Unit

2. Remove three screws securing the motor and control unit together. Grasp the Control Unit and pull away from motor until both units are separated. [Figure 7b].

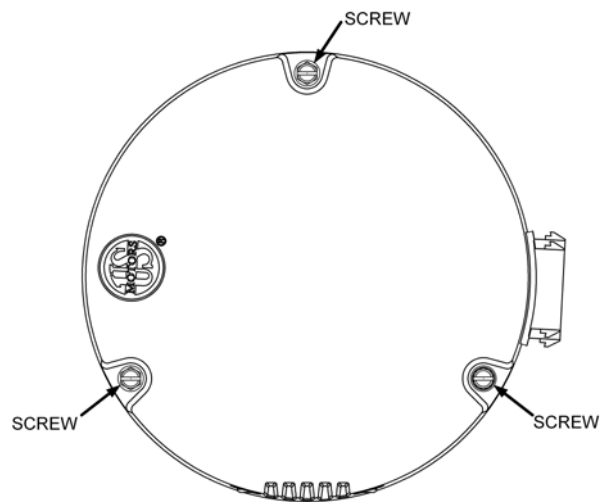
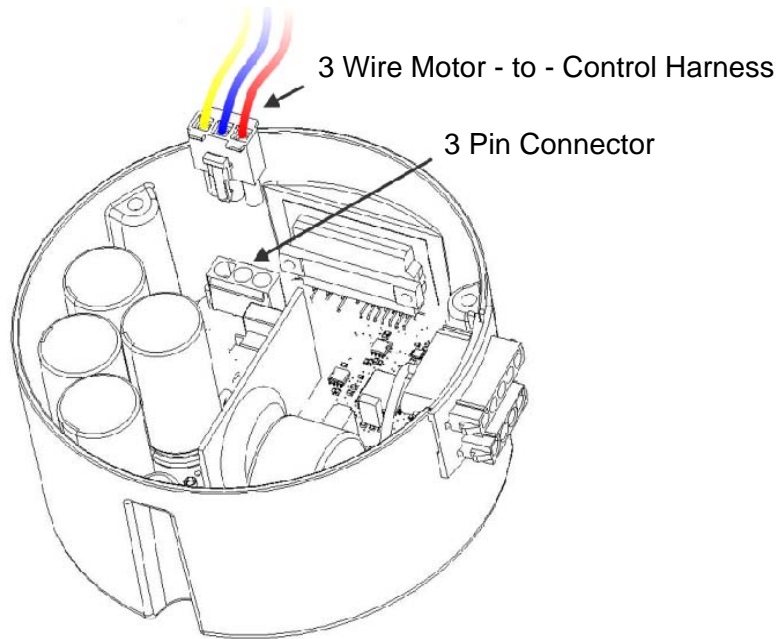

Figure 7b

3. Disconnect the three-wire motor - to - control harness from the control [Figure 8] and remove control unit. Inspect for bent, damaged, or recessed wires and terminals inside of connector.
  - Replace control unit if three pin connector contains bent, damaged or recessed terminals.



**Figure 8**

4. Inspect the NTC thermistor inside of control unit for any cracks or breakage [Figure 9].
  - Replace control unit if NTC thermistor is cracked or broken.

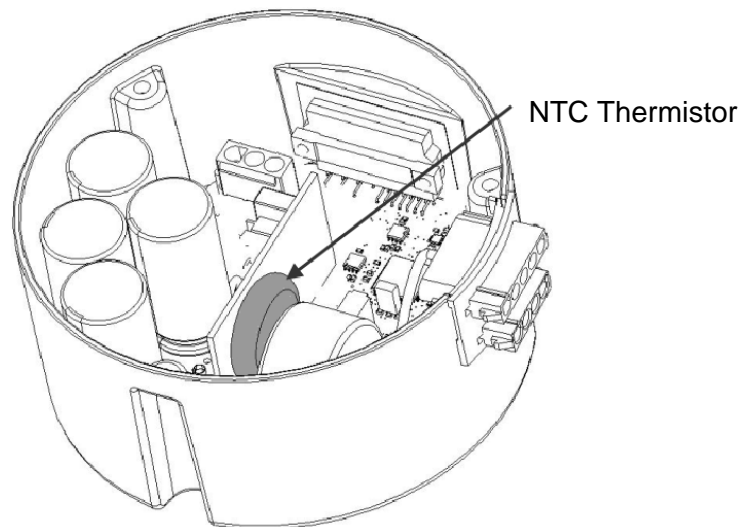

**Figure 9**



5. Inspect capacitors inside of control unit for bulging or swelling. [Figure 10].
- Replace control unit if capacitors are bulging or swollen.

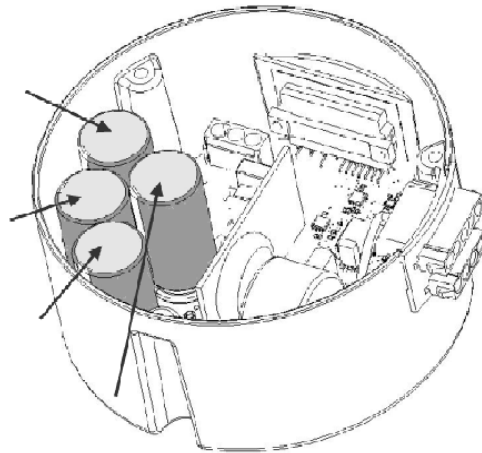

**Figure 10**

6. Check phase to phase resistance between each of the three phase pins in the harness connector [Figure 11]. Resistance levels between any two pins should be greater than 100K.
- If the multimeter indicates resistance levels greater than 100K, the control unit is functioning properly. Next to verify motor functionality, proceed to Check 4.
  - Replace control if multimeter indicates resistance levels lower than 100K.

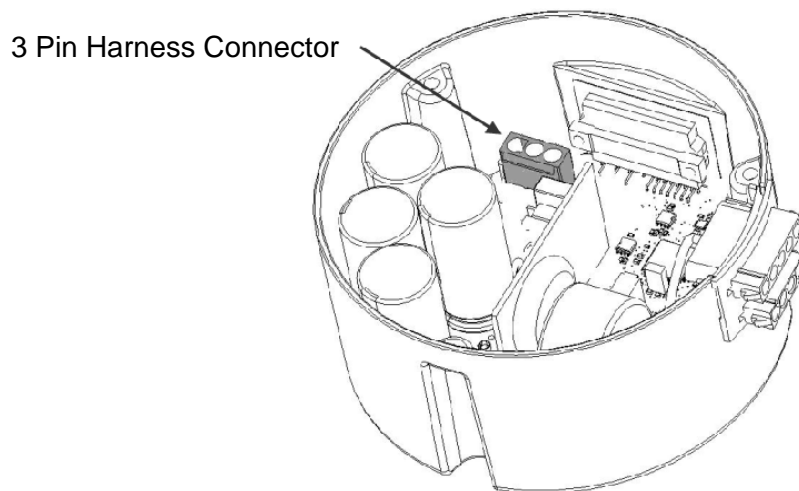

**Figure 11**

## Check 4 : Motor Verification

1. Disconnect or turn off AC power to the furnace, air handler, or system being serviced. Wait 2 minutes to allow the capacitors to fully discharge.
2. Make sure the motor shaft spins freely without effort manually in both directions [Figure 12].
  - If motor shaft spins freely, go to step 3.
  - Replace motor if the shaft does not spin freely without effort manually.

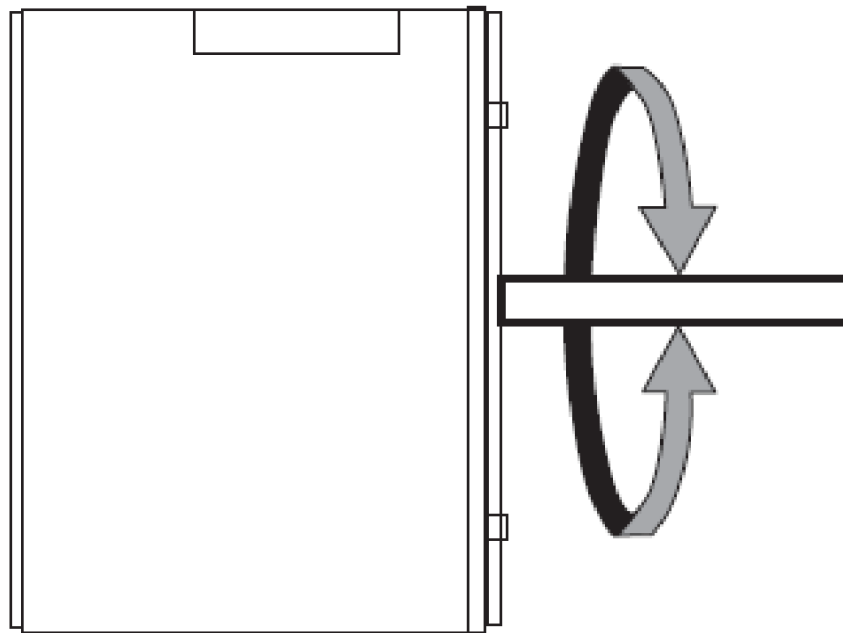
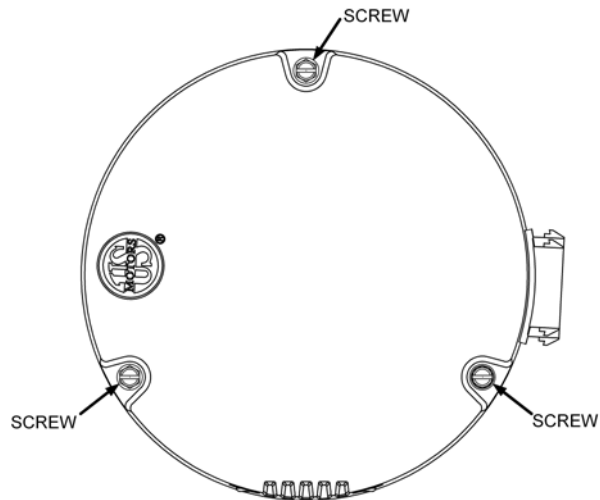

Figure 12

## Removing Control Unit (if still mounted to the motor)

3. Remove three screws securing the motor and control unit together. Grasp the control unit and pull away from motor until both units are separated [Figure 13].



**Figure 13**

4. Disconnect the three-wire motor-to-control harness from the control [Figure 14] and remove control unit [Figure 13]. Inspect for bent, damaged, or recessed wires and terminals inside of connector.
  - Replace control unit if the three pin connector contains bent, damaged, or recessed terminals.

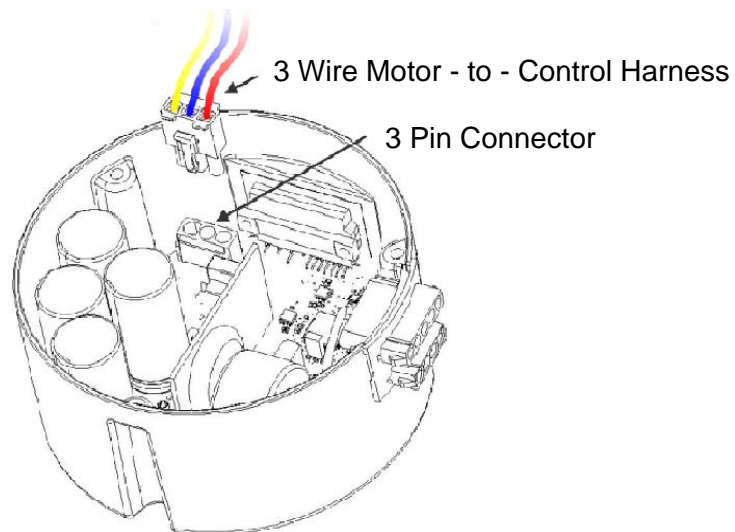

**Figure 14**

5. Inspect connector on back side of motor for bent, damaged, or recessed wires and terminals [Figure 15].
  - Replace motor if connector contains bent, damaged, or recessed wires or terminals.

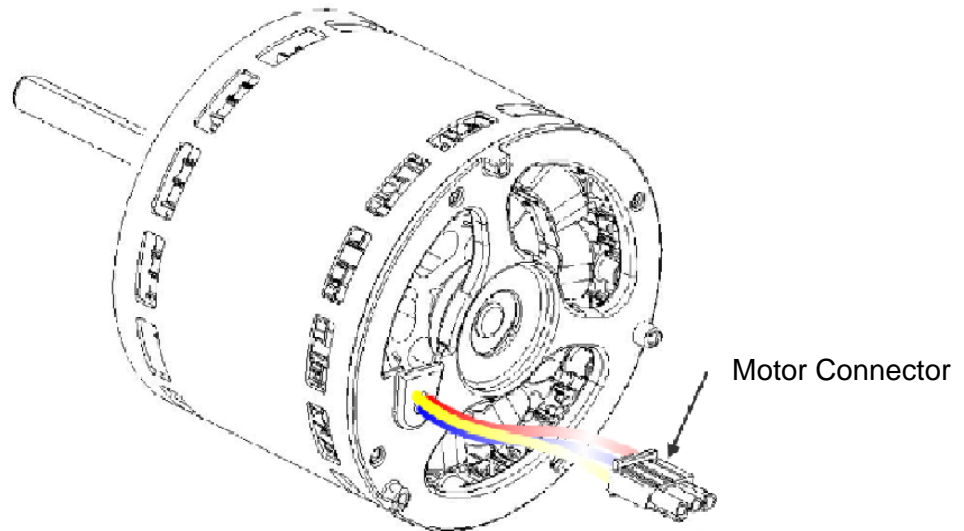

**Figure 15**

6. Check phase to phase resistance between each of the three phase terminals in the motor connector.

**Resistance levels between any two contacts should be equal.**

- If resistance levels are equal the motor is functioning properly.
- Replace motor if the resistance levels are not equal.
- Replace motor if the resistance levels are open circuited or short circuited.

7. Inspect the magnets through the back side of motor for broken or chipped magnets on the rotor core [Figure 16].
- Replace motor if magnets on the rotor core are broken or chipped.

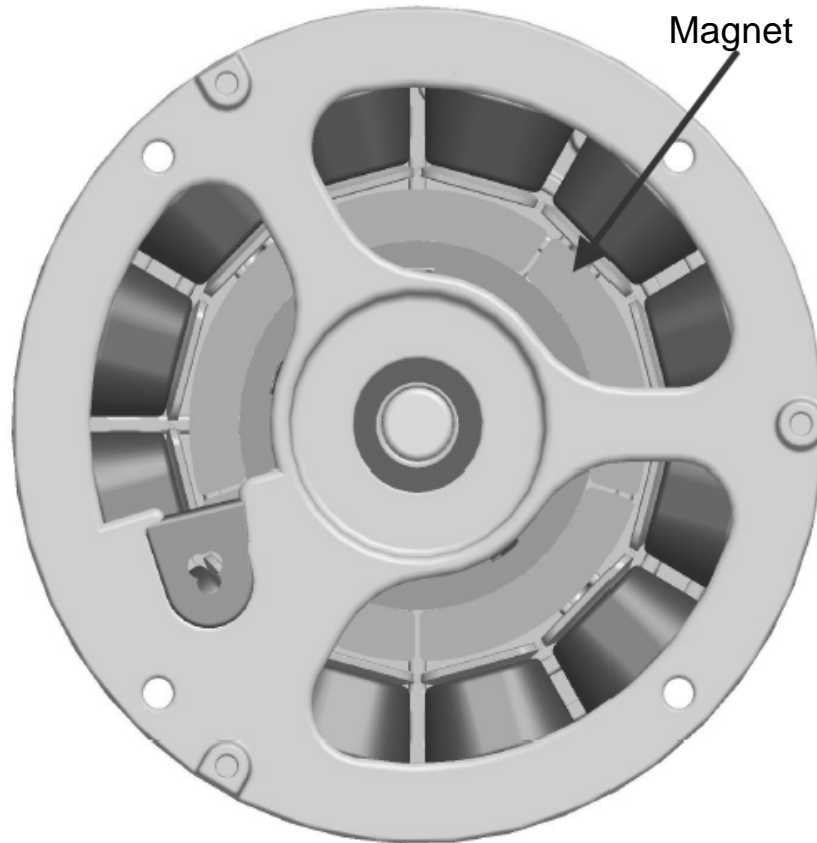

**Figure 16**

- If both motor and control unit appear to be functioning correctly, reassemble motor and control unit and contact HVAC system manufacturer.

## Final Checks

- Check mounting and fastening of motor and control. Make sure control unit and motor are securely attached together and mounted tightly in HVAC system.
- Check control unit connectors. Inspect for shorts, detached wiring, or loose connections.
- Check power cord and communication cable connections. Make sure both are securely connected to control unit connectors.
- Check blower motor and verify wheel rotation. Make sure it spins freely manually without effort or assisted means in both directions.
- Check circuit breakers.



**NIDEC MOTOR CORPORATION**

8050 W. Florissant Avenue | St. Louis, MO 63136

*†All marks shown within this document are properties of their respective owners.*



RP921

*Nidec Motor Corporation, 2012; All Rights Reserved. U.S. Motors®, PerfectSpeed®, and Ultracheck-EZ® are registered trademarks of Nidec Motor Corporation.*

*Nidec Motor Corporation trademarks followed by the ® symbol are registered with the U.S. Patent and Trademark Office.*