



A **NIBE** GROUP MEMBER



COMMERCIAL
TRANQUILITY® 24 (SY) COMPACT TWO-STAGE SERIES
PRODUCT CATALOG

Part#: LC3002 | Updated: August 8, 2024

Models: SY 024-060
60 Hz - R-454B

Table of Contents

Models:
SY
024-060

3	Introduction	28	Full Load Performance: Correction Tables
4	Features, Options, and Accessories	29	Antifreeze Correction Table
5	iGate 2 Communicating Controls Powered by DXM2.5	31	Physical Data
6	Communicating (AWC) Thermostat	32	Dimensional Data
7	myUplink: Web and Mobile Interface	34	Corner Weights
8	Selection Procedure	36	Horizontal Service Access
10	Model Nomenclature	38	Vertical Service Access
11	Performance Data: AHRI/ASHRAE/ISO 13256-1	39	Minimum Installation Area
13	Performance Data: Selection Notes	41	Electrical Data: (CV) EC Blower Motor Standard Unit
14	Performance Data	42	Engineering Specifications
26	Blower Performance: (CV) EC Standard Unit	51	Revision History
27	Part Load Performance: Correction Tables		

THE TRANQUILITY® 24 (SY) COMPACT TWO-STAGE SERIES

The Tranquility 24 (SY) Compact Two-Stage Series comes with all the reliability features for which the ClimateMaster Tranquility Series is known. They include superb efficiency ratings, quiet operation, and application flexibility. Tranquility SY surpasses ASHRAE 90.1 efficiency standards and utilizes R-454B low Global Warming Potential (GWP) refrigerant, setting a high standard for eco-friendly performance. The SY qualifies for LEED® (Leadership in Energy and Environmental Design) points due to its innovative and environmentally-conscious design. It also has one of the industry's smallest footprints, making it suitable for installation in tight places and for replacement/retrofit projects.

Available in sizes 2 tons (7.0 kW) through 5 tons (17.6 kW) with multiple cabinet options (vertical upflow and horizontal), the Tranquility SY offers a wide range of units for most any installation. The Tranquility SY has an extended range refrigerant circuit, capable of ground loop (geothermal) applications as well as water loop (boiler-tower) applications. Standard features are many. Ultra-efficient two-stage unloading scroll compressor, EC variable fan, microprocessor controls, galvanized steel cabinet, non-corrosive polymer drain pan, and acoustic type fiber insulation are just some of the features of the innovative Tranquility SY Series.

Recent EPA mandates require an industry transition to low-GWP refrigerants, such as R-454B which is a gas that is classified as having low-toxicity, low-flammability rating. Due to these characteristics, R-454B systems charged with over 62 ounces of refrigerant must contain an integrated Refrigerant Detection System (RDS). In the unlikely event of a system-refrigerant leak, the RDS shuts down compressor operation and runs the unit blower motor to disperse any concentration of leaked refrigerant in compliance with UL 60335-2-40 safety standards. For Tranquility SY products, only the 5-ton size (060) is required to have the RDS and the feature is optional on all other sizes.

ClimateMaster's exclusive double isolation compressor mounting system makes the Tranquility SY one of the quietest units on the market. Compressors are mounted on specially engineered sound tested EPDM grommets to a heavy gauge mounting plate, which is then isolated from the cabinet base with EPDM grommets to minimize vibration transmission and maximize sound attenuation. The easy access control box makes installing and maintaining the unit easier than any other water-source heat pump currently in production. Options such as coated air coil, DDC controls, and high efficiency MERV rated air filters allow customized design solutions.

iGate® 2 technology provides technicians an interface into the operation of the system in real time without the need for hard tooling. On-board advanced controls communicate the key operating system temperatures enabling technicians to startup, commission, and service the equipment remotely by smart phone or website via the cloud. Communication can also be done at the unit via a communicating thermostat or handheld service tool. Not only does iGate 2 monitor current performance, it also allows the functionality to make system adjustments and captures operating conditions at time of fault. All this information is displayed in an easy-to-read format maximizing the usability of the experience.

The Tranquility 24 (SY) Compact Two-Stage Series water-source heat pumps are designed to meet the challenges of today's HVAC demands with one of the most innovative products available on the market.

FEATURES

- Sizes 024 (2 ton, 7 kW) through 060 (5 tons, 17.6 kW)
- Exceeds ASHRAE 90.1 efficiency standards
- Environmentally-friendly R-454B low-GWP refrigerant
- Refrigerant Detection System (RDS) (mandatory on size 060, optional feature for sizes 024-048)
- Intelligent variable-speed Constant Volume (CV) EC blower motors for precise airflow control and soft-start feature
- Part-load operation significantly lowers annual operating costs
- Galvanized-steel cabinet construction
- Sound-absorbing glass-fiber insulation
- Insulated divider and separate compressor/air-handler compartments
- TXV metering device
- Field-convertible supply-air arrangement (horizontal configurations only)
- Unit Performance Sentinel performance-monitoring system
- Easy-access swing-out control box
- Unit Performance Sentinel performance-monitoring system
- Eight standard safety features
- Non-corrosive polymer drain pan
- External Connecting Port on front-left corner post facilitates service tool connectivity, thereby reducing startup, commissioning, and service time
- Communicating Controls Powered by DXM2.5:
 - Multiple communication pathways for unit access and diagnosis
 - Cloud-based remote monitoring via Wi-Fi communicating color-touchscreen thermostat
 - Connect directly to the system with a handheld service tool
 - Provides real-time unit operating conditions
 - Reduces startup, commissioning, and service time by providing key system temperatures electronically

- Captures operating conditions in the event of a safety shutdown

OPTIONS

- BACnet, Modbus, and Johnson Controls N2 compatibility options for Building Management Systems (BMS)
- Corrosion-resistant cupro-nickel water heat exchanger
- UltraQuiet sound-attenuation package
- Tin-plated air coils for added protection from formicary corrosion
- Easy-to-clean rust-prohibitive stainless-steel drain pans
- Integrated-power disconnect
- Extended-range insulation for geothermal applications

ACCESSORIES

- Wi-Fi communicating (AWC) thermostat with color touchscreen
- Wide variety of thermostat options to meet your application needs
- Braided-hose kits in various lengths with optional water valve, PT plugs, blowdown valve, flow regulator, and strainer
- Externally-mounted manual and motorized water valves
- 1-inch Merv 8 filter
- 2-inch Merv 8 or 13 filters
- Aesthetically-pleasing wall sensors for connection to BMS (MPC) controls

iGATE 2 COMMUNICATION – CLOUD CONNECTED, WEB-ENABLED INFORMATION GATEWAY TO MONITOR, CONTROL, AND DIAGNOSE YOUR SYSTEM

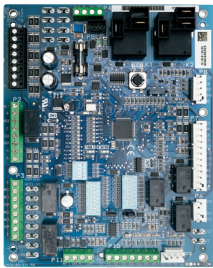

The Tranquility (SY) is equipped with industry-first, iGate 2 communication information gateway that allows users to interact with their water-source system in easy to read clear language AND delivers improved reliability and efficiency by precisely

controlling smart components.

Monitor/Configure – Installers can configure from the myUplink PRO website, mobile app, Communicating AWC Thermostat, or diagnostic tool, including: airflow, unit family, size, accessory configuration, and demand reduction (optional, to limit unit operation during peak times). Users can look up the current system status: temperature sensor readings and operational status of the blower.

Precise Control – The new DXM2.5 board enables intelligent, two-way communication between the DXM2.5 board and smart components like the communicating thermostat/diagnostic tool and constant volume CV EC blower motor. The advanced DXM2.5 board uses information received from the smart components and temperature sensors to precisely control operation of the variable speed CV EC fan to deliver higher efficiency, reliability and increased comfort.

Diagnostics – iGate 2 takes diagnosing water source heat pump units to a next level of simplicity, by providing a dashboard of system and fault information, in clear language, on the AWC Communicating Thermostat, handheld service tool and the web portal/mobile app on the internet.

iGate 2 Service Warnings notify the homeowner and contractor of a fault and displays fault descriptions by app notifications and email with possible causes. Additionally, the current system status can be viewed graphically on the web portal and mobile app.

In iGate 2 Service Mode, the service personnel can access fault description, possible causes and most importantly, the conditions (temp, flow, i/o conditions, configuration) at the time of the fault. Manual Operation mode allows the service personnel to manually command operation for any of the thermostat outputs, blower speed, to help troubleshoot specific components. This operation can either be conducted at the unit with a diagnostic tool or remotely with mobile app/website when the AWC Communicating Thermostat controls are used.

With an iGate 2 communicating system, users and contractors have a web-enabled gateway to system information never before available and exclusive to ClimateMaster products.

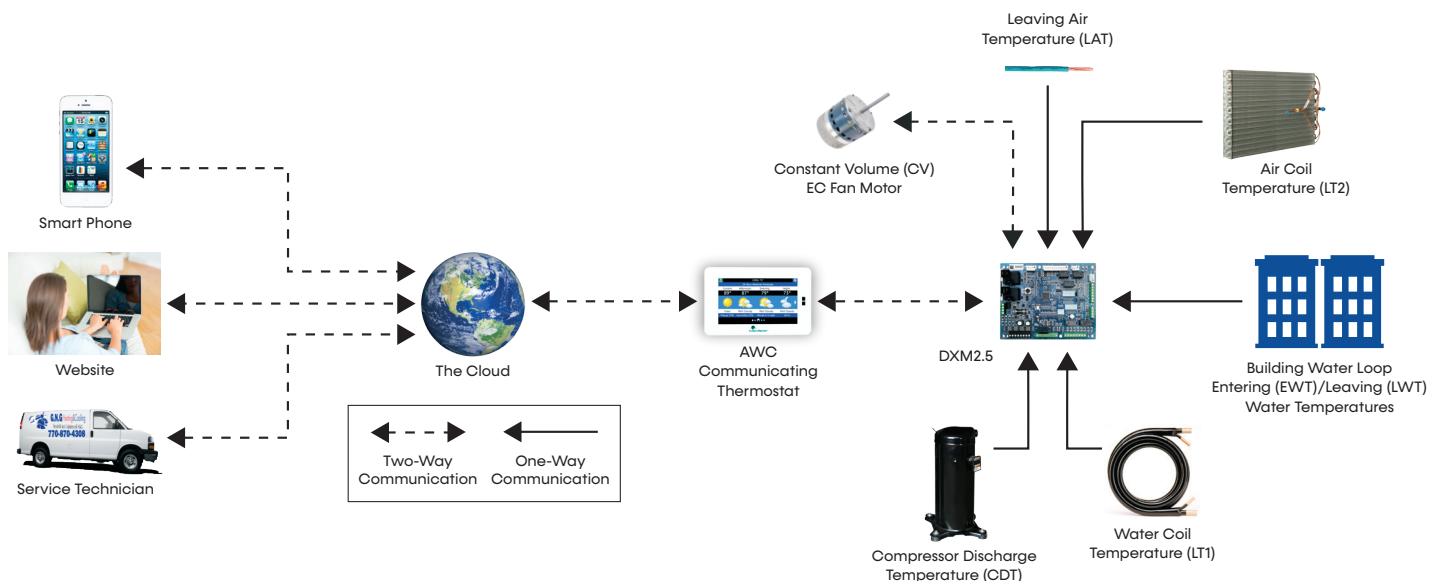

ClimateMaster works continually to improve its products. As a result, the design and specifications of each product at the time of order may be changed without notice and may not be as described herein. Please contact ClimateMaster's Customer Service Department at 800-299-9747 for specific information on the current design and specifications. Statements and other information contained herein are not express warranties and do not form the basis of any bargain between the parties, but are merely ClimateMaster's opinion or commendation of its products. The latest version of this document is available at www.climatemaster.com. Engineered and assembled in the USA. © ClimateMaster, Inc. All Rights Reserved 2024

IGATE 2 COMMUNICATION – CLOUD CONNECTED, WEB-ENABLED INFORMATION GATEWAY TO MONITOR, CONTROL, AND DIAGNOSE YOUR SYSTEM

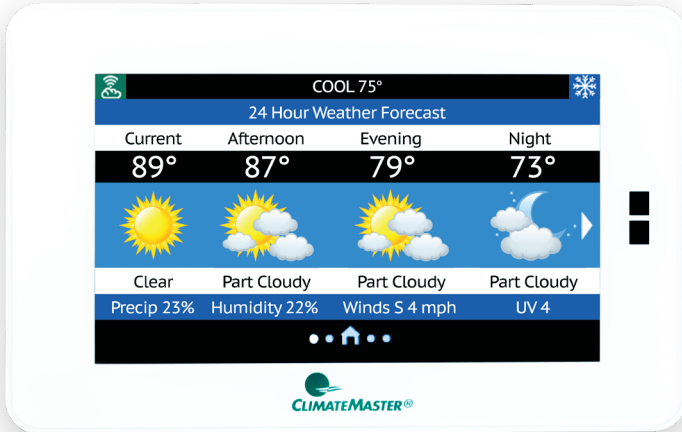

The Communicating (AWC) Thermostat is innovating the future of comfort technology, one building at a time. The inspired design of the touch screen interface allows you to see real-time data for the efficiency and health of your system, with early warnings for potential system faults. The cloud based information gateway allows technicians to remotely diagnose system issues before occupants even know there is a problem. Control and monitor the system in your home or business from anywhere in the world with an easy to use app on your phone.

Features with Efficiency in Mind



Touch Screen Interface

A brilliantly customizable touch screen monitor for simple control.



Seamless Integration

Between your Communicating (AWC) Thermostat and comfort system.



(Mobile) Remote System Control

Control temperature and schedule from anywhere in the world.



Early Fault Warnings

Alerts the building owner and the contractor of potential system faults in the future.



Remote Diagnostics

Enable the contractor to remotely diagnose system issues, adjust system settings, and reset faults.



Real-Time Operations Data and System Schematics

Access simply via the myUplink Pro Account and web portal to view system diagrams with current operating temperatures.



Revenue Stream

HVAC professionals can offer owners service contracts with remote monitoring and diagnostic capabilities without the large expense of a building management system.



ClimateMaster works continually to improve its products. As a result, the design and specifications of each product at the time of order may be changed without notice and may not be as described herein. Please contact ClimateMaster's Customer Service Department at 800-299-9747 for specific information on the current design and specifications. Statements and other information contained herein are not express warranties and do not form the basis of any bargain between the parties, but are merely ClimateMaster's opinion or commendation of its products. The latest version of this document is available at www.climatemaster.com. Engineered and assembled in the USA. © ClimateMaster, Inc. All Rights Reserved 2024

HVAC Professional | User Experience

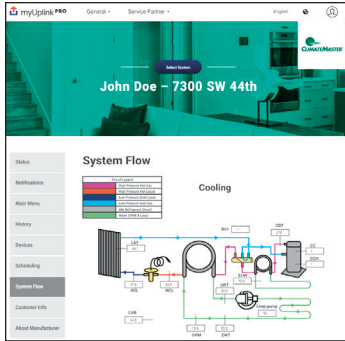

The iGate 2 establishes a two-way link between the communicating (AWC) thermostat and the cloud, adding significant value for both residential and commercial customers. Our new thermostat works

with your customers' Tranquility comfort systems to provide the most efficient link between their system and your services. The customizable monitoring from the myUplink PRO web portal or phone app account allows for continuous system monitoring, analysis, repair recognition, and early warnings for potential system faults that are sent to you and your customer.



Benefits

- Remote login from anywhere, anytime from any internet connected device
- View system fault history with possible root causes
- Information is available for contractors to troubleshoot and diagnose systems remotely
- Secure internet connection keeps homeowner information private
- Access thermostat(s) through Android and iPhone mobile apps

Homeowner | User Experience

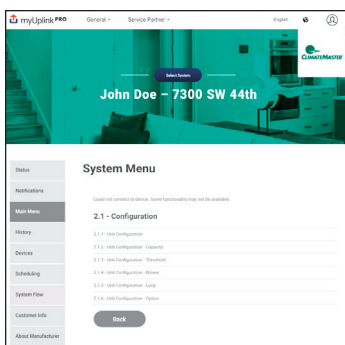

The iGate 2 advanced unit controls enable a two-way communication link for critical system information between the unit and the cloud. From any internet connected device or smart phone, building owners can control and monitor their systems

from anywhere in the world. iGate 2 offers building owners peace of mind their systems are operating at peak performance with advanced operational performance issue notifications. HVAC professionals get notifications when systems are operating out of range. They can log in remotely to check system faults, review current operating conditions, and diagnose issues remotely. This gives the HVAC technician the upper hand when showing up to perform service, saving time which in turn, saves money.



Benefits

- Communicates personal settings and reminders through the iGate 2 communication system
- Easy-to-use, full-color, high-resolution user interface
- Sleek, intuitive control panel
- Secure internet connection keeps your information private
- Contains unit model, serial number and your HVAC professionals contact information
- System monitoring automatically contacts HVAC system providers when service is needed

Reference Calculations

Heating	Cooling
$LWT = EWT - \frac{HE}{GPM \times \text{Constant}}$	$LWT = EWT + \frac{HR}{GPM \times \text{Constant}} \quad LC = TC - SC$
$LAT = EAT + \frac{HC}{CFM \times 1.08}$	$LAT (DB) = EAT (DB) - \frac{SC}{CFM \times 1.08} \quad S/T = \frac{SC}{TC}$

Constant = 500 for water, 485 for antifreeze

Conversion Table - to convert inch-pound (English) to S-I (Metric)

Airflow	Water Flow	External Static Pressure	Water Pressure Drop
Airflow (L/s) = CFM x 0.472	Water Flow (L/s) = GPM x 0.0631	ESP (Pa) = ESP (in of wg) x 249	PD (kPa) = PD (ft of hd) x 2.99

Legend and Glossary of Abbreviations

Abbreviations	Descriptions
Btuh	Btu (British Thermal Unit) per hour
BMS	Building Management System
CDT	Compressor discharge temperature
CFM	Airflow, cubic feet per minute
COP	Coefficient of performance = Btuh output/Btuh input
CT EC	Electronically commutated constant torque blower motor
CV EC	Electronically commutated constant volume blower motor
DB	Dry bulb temperature, °F
DT	Delta T
EAT	Entering air temperature
EER	Energy efficient ratio = Btuh output/Watt input
ESP	External static pressure, inches w.g.
EWT	Entering water temperature
FPT	Female pipe thread
GPM	Water flow in U.S., gallons per minute
HC	Air heating capacity, Btuh
HE	Total heat of extraction, Btuh
HR	Total heat of rejection, Btuh

Abbreviations	Descriptions
HWG	Hot water generator (desuperheater) capacity, MBtuh
kW	Total power unit input, kilowatts
LAT	Leaving air temperature, °F
LC	Latent cooling capacity, Btuh
LOC	Loss of charge
LWT	Leaving water temperature, °F
MBtuh	1,000 Btu per hour
MPT	Male pipe thread
MWV	Motorized water valve
PSC	Permanent split capacitor
RDS	Refrigerant Detection System
SC	Sensible cooling capacity, Btuh
S/T	Sensible to total cooling ratio
TC	Total cooling capacity, Btuh
TD or delta T	Temperature differential
VFD	Variable frequency drive
WB	Wet bulb temperature, °F
WPD	Waterside pressure drop, psi or feet of head
WSE	Waterside economizer

ClimateMaster works continually to improve its products. As a result, the design and specifications of each product at the time of order may be changed without notice and may not be as described herein. Please contact ClimateMaster's Customer Service Department at 800-299-9747 for specific information on the current design and specifications. Statements and other information contained herein are not express warranties and do not form the basis of any bargain between the parties, but are merely ClimateMaster's opinion or commendation of its products. The latest version of this document is available at www.climatemaster.com. Engineered and assembled in the USA. © ClimateMaster, Inc. All Rights Reserved 2024

USE THE FOLLOWING SELECTION STEPS

1. Determine the actual heating and cooling loads at the desired dry bulb and wet bulb conditions.
2. Obtain the following design parameters: Entering water temperature, water flow rate in GPM, airflow in CFM, water flow pressure drop and design wet and dry bulb temperatures. Airflow CFM should be between 300 and 450 CFM per ton. Unit water pressure drop should be kept as close as possible to each other to make water balancing easier. Go to the appropriate tables and find the proper indicated water flow and water temperature.
3. Select a unit based on total and sensible cooling conditions. Select a unit which is closest to, but no larger than, the actual cooling load.
4. Enter tables at the design water flow and water temperature. Read the total and sensible cooling capacities

Note: interpolation is permissible, extrapolation is not.

5. Read the heating capacity. If it exceeds the design criteria it is acceptable. It is quite normal for water-source heat pumps to be selected on cooling capacity only since the heating output is usually greater than the cooling capacity.
6. Determine the correction factors associated with the variable factors of dry bulb and wet bulb.

Corrected Total Cooling =
tabulated total cooling x wet bulb correction.

Corrected Sensible Cooling =
tabulated sensible cooling x wet/dry bulb correction.

7. Compare the corrected capacities to the load requirements. Normally if the capacities are within 10% of the loads, the equipment is acceptable. It is better to undersize than oversize, as undersizing improves humidity control, reduces sound levels and extends the life of the equipment.
8. When completed, calculate water temperature rise and assess the selection. If the units selected are not within 10% of the load calculations, then review what effect changing the GPM, water temperature and/or air flow and air temperature would have on the corrected capacities. If the desired capacity cannot be achieved, select the next larger or smaller unit and repeat the procedure. Remember, when in doubt, undersize slightly for best performance.

EXAMPLE EQUIPMENT SELECTION FOR COOLING

Step 1: Load Determination

Assume we have determined that the appropriate cooling load at the desired dry bulb 80°F and wet bulb 65°F conditions is as follows:

Total Cooling 22,000 Btuh
Sensible Cooling 18,200 Btuh
Entering Air Temp..... 80°F Dry Bulb / 65°F Wet Bulb

Step 2: Design Conditions

Similarly, we have also obtained the following design parameters:

Entering Water Temp 90°F
Water Flow (Based upon 10°F rise in temp) .4.5 GPM
Airflow 600 CFM

Steps 3, 4, and 5: HP Selection

After making our preliminary selection (SY024), we enter the tables at design water flow and water temperature and read Total Cooling, Sensible Cooling and Heat of Rejection capacities:

Total Cooling 22,500 Btuh
Sensible Cooling 16,500 Btuh
Heat of Rejection 28,800 Btuh

Steps 6 and 7: Entering Airflow Corrections

Next, we determine our correction factors.

Corrected Values	Table	Ent Air	Airflow	Corrected
Corrected Total Cooling	= 22,500 x	0.976 x	0.967 =	21,235
Corrected Sensible Cooling	= 16,500 x	0.919 x	1.089 =	16,513
Corrected Heat of Rejection	= 28,800 x	0.969 x	0.972 =	27,126

Step 8: Water Temperature Rise Calculation and Assessment

Actual Temperature Rise 12.1°F

When we compare the Corrected Total Cooling and Corrected Sensible Cooling figures with our load requirements stated in Step 1, we discover that our selection is within ±10% of our sensible load requirement. Furthermore, we see that our Corrected Total Cooling figure is within 1,000 Btuh the actual indicated load.

ClimateMaster works continually to improve its products. As a result, the design and specifications of each product at the time of order may be changed without notice and may not be as described herein. Please contact ClimateMaster's Customer Service Department at 800-299-9747 for specific information on the current design and specifications. Statements and other information contained herein are not express warranties and do not form the basis of any bargain between the parties, but are merely ClimateMaster's opinion or commendation of its products. The latest version of this document is available at www.climatemaster.com. Engineered and assembled in the USA. © ClimateMaster, Inc. All Rights Reserved 2024

Model Nomenclature

Models:
SY
024-060

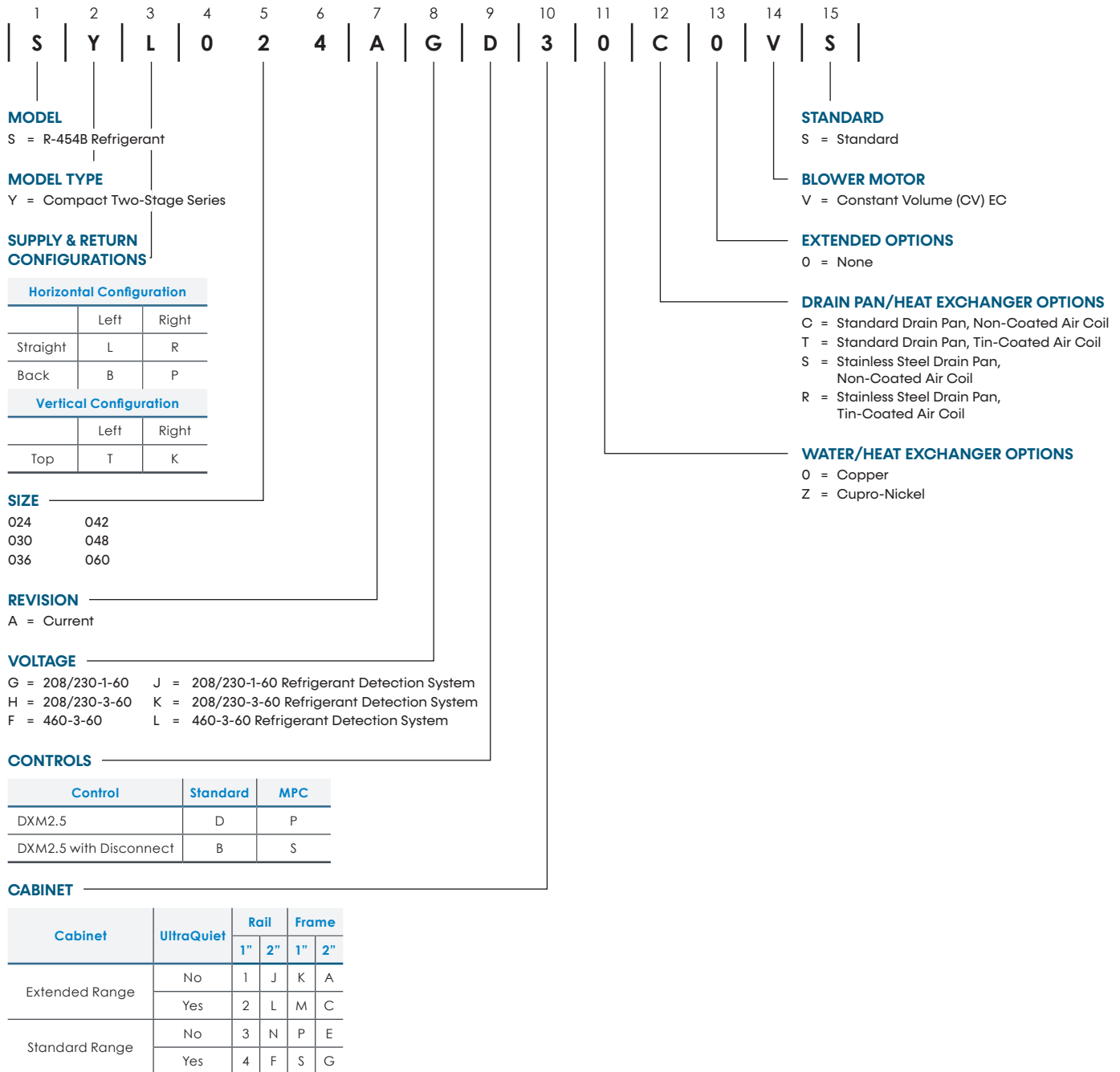

Use ClimateMaster's selection software at <https://climatemastersolutions.com/eRep/> to configure your Tranquility SY model.

Performance Data: AHRI/ASHRAE/ISO 13256-1

Models:
SY
024-060

ASHRAE/AHRI/ISO 13256-1 English (I-P) Units Part Load

Model	Motor Type	WSHP (Part Load)											
		Water Loop Heat Pump				Ground Water Heat Pump				Ground Loop Heat Pump			
		Cooling 86°F		Heating 68°F		Cooling 59°F		Heating 50°F		Cooling 68°F		Heating 41°F	
		Capacity Btuh	EER Btuh/W	Capacity Btuh	COP	Capacity Btuh	EER Btuh/W	Capacity Btuh	COP	Capacity Btuh	EER Btuh/W	Capacity Btuh	COP
SY024	EC	17,500	17.0	19,900	5.7	20,000	29.7	16,600	4.8	19,300	25.3	14,600	4.2
SY030	EC	21,200	15.2	24,400	5.1	24,700	26.4	20,800	4.4	23,400	22.0	18,700	4.0
SY036	EC	26,100	16.1	31,600	5.3	29,900	26.0	25,700	4.4	28,500	22.6	22,600	4.1
SY042	EC	32,500	17.0	36,000	5.1	36,000	28.5	29,800	4.5	35,000	23.5	26,400	4.0
SY048	EC	34,000	16.5	39,000	5.5	38,500	28.5	31,800	4.5	37,000	24.0	28,000	4.0
SY060	EC	42,000	17.5	47,300	5.5	47,000	29.0	38,500	4.7	45,500	24.9	34,000	4.2

Notes:

- Where dual voltages are available ratings are based on the lower voltage setting.
- Cooling capacities based upon 80.6°F DB, 66.2°F WB entering air temperature.
- Heating capacities based upon 68°F DB, 59°F WB entering air temperature.
- Ground Loop Heat Pump ratings based on 15% antifreeze solution.

ASHRAE/AHRI/ISO 13256-1 English (I-P) Units Full Load

Model	Motor Type	WSHP (Full Load)											
		Water Loop Heat Pump				Ground Water Heat Pump				Ground Loop Heat Pump			
		Cooling 86°F		Heating 68°F		Cooling 59°F		Heating 50°F		Full Cooling 77°F		Full Heating 32°F	
		Capacity Btuh	EER Btuh/W	Capacity Btuh	COP	Capacity Btuh	EER Btuh/W	Capacity Btuh	COP	Capacity Btuh	EER Btuh/W	Capacity Btuh	COP
SY024	EC	24,000	15.1	28,400	5.3	27,000	24.1	23,500	4.7	25,000	18.0	18,400	3.9
SY030	EC	28,700	14.0	33,200	4.6	32,900	21.7	28,700	4.1	30,200	16.3	23,200	3.6
SY036	EC	35,000	14.0	44,200	4.6	39,300	20.2	36,300	4.2	36,400	16.4	28,600	3.6
SY042	EC	43,000	15.5	49,500	4.7	47,500	22.8	41,000	4.2	44,500	17.3	32,500	3.5
SY048	EC	47,500	15.5	55,000	4.8	52,000	22.9	45,000	4.3	49,000	17.7	36,000	3.7
SY060	EC	59,000	15.5	67,200	5.0	65,000	22.8	55,700	4.4	61,500	17.8	44,600	3.7

Notes:

- Where dual voltages are available ratings are based on the lower voltage setting.
- Cooling capacities based upon 80.6°F DB, 66.2°F WB entering air temperature.
- Heating capacities based upon 68°F DB, 59°F WB entering air temperature.
- Ground Loop Heat Pump ratings based on 15% antifreeze solution.

Performance Data: AHRI/ASHRAE/ISO 13256-1

Models:
SY
024-060

ASHRAE/AHRI/ISO 13256-1 Metric (S-I) Units Part Load

Model	Motor Type	WSHP (Part Load)											
		Water Loop Heat Pump				Ground Water Heat Pump				Ground Loop Heat Pump			
		Cooling 30°C		Heating 20°C		Cooling 15°C		Heating 10°C		Cooling 25°F		Heating 0°F	
		Capacity kW	EER W/W	Capacity kW	COP	Capacity kW	EER W/W	Capacity kW	COP	Capacity kW	EER W/W	Capacity kW	COP
SY024	EC	5	5.0	6	5.7	6	8.7	5	4.8	6	7.4	4	4.2
SY030	EC	6	4.5	7	5.1	7	7.7	6	4.4	7	6.5	5	4.0
SY036	EC	8	4.7	9	5.3	9	7.6	8	4.4	8	6.6	7	4.1
SY042	EC	10	5.0	11	5.1	11	8.4	9	4.5	10	6.9	8	4.0
SY048	EC	10	4.8	11	5.5	11	8.4	9	4.5	11	7.0	8	4.0
SY060	EC	12	5.1	14	5.5	14	8.5	11	4.7	13	7.3	10	4.2

Notes:

- Where dual voltages are available ratings are based on the lower voltage setting.
- Cooling capacities based upon 20°C DB, 15°C WB entering air temperature.
- Heating capacities based upon 20°C DB, 15°C WB entering air temperature.
- Ground Loop Heat Pump ratings based on 15% antifreeze solution.

ASHRAE/AHRI/ISO 13256-1 Metric (S-I) Units Full Load

Model	Motor Type	WSHP (Full Load)											
		Water Loop Heat Pump				Ground Water Heat Pump				Ground Loop Heat Pump			
		Cooling 30°C		Heating 30°C		Cooling 15°C		Heating 10°C		Full Cooling 25°F		Full Heating 0°F	
		Capacity kW	EER W/W	Capacity kW	COP	Capacity kW	EER W/W	Capacity Btuh	COP	Capacity kW	EER W/W	Capacity kW	COP
SY024	EC	7	4.4	8	5.3	8	7.1	7	4.7	7	5.3	5	3.9
SY030	EC	8	4.1	10	4.6	10	6.4	8	4.1	9	4.8	7	3.6
SY036	EC	10	4.1	13	4.6	12	5.9	11	4.2	11	4.8	8	3.6
SY042	EC	13	4.5	15	4.7	14	6.7	12	4.2	13	5.1	10	3.5
SY048	EC	14	4.5	16	4.8	15	6.7	13	4.3	14	5.2	11	3.7
SY060	EC	17	4.5	20	5.0	19	6.7	16	4.4	18	5.2	13	3.7

Notes:

- Where dual voltages are available ratings are based on the lower voltage setting.
- Cooling capacities based upon 27°C DB, 19°C WB entering air temperature.
- Heating capacities based upon 20°C DB, 15°C WB entering air temperature.
- Ground Loop Heat Pump ratings based on 15% antifreeze solution.

Performance Data: Selection Notes

Models:
SY
024-060

For operation in the shaded area when water is used in lieu of an antifreeze solution, the LWT (Leaving Water Temperature) must be calculated. Flow must be maintained to a level such that the LWT is maintained above 40°F (4.4°C) when the JW3 jumper is not clipped (see example below). Otherwise, appropriate levels of a proper antifreeze solution should be used in systems with leaving water temperatures of 40°F (4.4°C) or below and the JW3 jumper should be clipped. This is due to the potential of the refrigerant temperature being as low as 32°F (0°C) with 40°F (4.4°C) LWT, which may lead to a nuisance cutout due to the activation of the Low Temperature Protection. JW3 should never be clipped for standard-range equipment or systems without antifreeze.

Example:

At 50°F EWT (Entering Water Temperature) and 1.5 GPM/ton, a 3-ton unit has a HE of 22,500 Btuh. To calculate LWT, rearrange the formula for HE as follows:

$HE = TD \times GPM \times 500$, where HE = Heat of Extraction (Btuh); TD = temperature difference (EWT - LWT) and GPM = U.S. Gallons per Minute.

$$TD = HE / (GPM \times 500)$$

$$TD = 22,500 / (1.5 \times 500)$$

$$TD = 10^\circ F$$

$$LWT = EWT - TD$$

$$LWT = 50 - 10 = 40^\circ F$$

In this example, as long as the EWT does not fall below 50°F, the system will operate as designed. For EWTs below 50°F, higher flow rates will be required (open loop systems, for example, require at least 2 GPM/ton when EWT is below 50°F).

Heating - EAT 70°F						
	EER	HC	Power kW	HE	LAT	COP
Not Recommended						
		4.0	0.45	2.5	84.6	2.6
8.6	27.4	4.6	0.46	3.0	86.8	2.9
8.6	31.0	4.8	0.47	3.2	87.8	3.0
8.6	33.0	4.9	0.47	3.3	88.3	3.1
8.4	23.3	5.4	0.48	3.8	90.2	3.3
8.5	26.3	5.7	0.49	4.0	91.4	3.4
8.6	27.9	5.9	0.49	4.2	92.1	3.5
8.2	19.8	6.2	0.50	4.5	93.6	3.7
4	22.3	6.6	0.50	4.9	95.0	3.8
	23.7	6.8	0.51	5.0	95.8	3.9
	16.7	7.0	0.51	5.3	96.9	4.0
	18.8	7.4	0.52	5.6	98.5	4.1
		7.6	0.52	5.8	99.3	4.2
			0.53	6.0	100.0	4.3

ClimateMaster works continually to improve its products. As a result, the design and specifications of each product at the time of order may be changed without notice and may not be as described herein. Please contact ClimateMaster's Customer Service Department at 800-299-9747 for specific information on the current design and specifications. Statements and other information contained herein are not express warranties and do not form the basis of any bargain between the parties, but are merely ClimateMaster's opinion or commendation of its products. The latest version of this document is available at www.climate-master.com. Engineered and assembled in the USA. © ClimateMaster, Inc. All Rights Reserved 2024

Performance Data SY*024 EC Blower Motor (Part Load)

Models:
SY
024-060

600 CFM Rated Airflow

EWT °F	GPM	WPD		COOLING - EAT 80/66.2 °F					GPM	WPD		HEATING - EAT 70°F				
		PSI	FT	TC	SC	KW	HR	EER		PSI	FT	HC	KW	HE	COP	
20	Operation Not Recommended									4.3	2.6	5.9	10.7	1.10	6.8	2.8
	2.2	0.8	1.9	20.4	14.5	0.59	22.4	34.7	2.2	0.8	1.9	12.2	1.11	8.2	3.2	
	3.2	1.4	3.3	19.9	14.0	0.54	21.8	36.8	3.2	1.4	3.3	12.7	1.12	8.7	3.3	
30	4.3	2.1	4.7	19.5	13.7	0.52	21.3	37.5	4.3	2.1	4.7	13.0	1.12	9.0	3.4	
	2.2	0.6	1.5	20.6	14.9	0.68	22.9	30.2	2.2	0.6	1.5	14.2	1.12	10.2	3.7	
	3.2	1.1	2.6	20.5	14.7	0.62	22.6	33.2	3.2	1.1	2.6	14.8	1.13	10.8	3.9	
40	4.3	1.7	3.9	20.4	14.5	0.59	22.4	34.6	4.3	1.7	3.9	15.2	1.13	11.2	3.9	
	2.2	0.5	1.1	20.2	14.9	0.76	22.9	26.5	2.2	0.5	1.1	16.2	1.14	12.2	4.2	
	3.2	0.9	2.1	20.5	15.0	0.69	22.9	29.7	3.2	0.9	2.1	16.9	1.14	12.9	4.4	
50	4.3	1.4	3.3	20.6	14.9	0.65	22.9	31.5	4.3	1.4	3.3	17.4	1.14	13.3	4.5	
	2.2	0.4	1.0	19.5	14.6	0.89	22.6	22.0	2.2	0.4	1.0	18.2	1.15	14.1	4.6	
	3.2	0.8	1.8	20.0	14.8	0.80	22.9	24.9	3.2	0.8	1.8	19.0	1.15	14.9	4.8	
60	4.3	1.3	2.9	20.2	14.9	0.76	22.9	26.6	4.3	1.3	2.9	19.5	1.16	15.4	4.9	
	2.2	0.4	0.9	18.5	14.2	1.03	22.1	18.0	2.2	0.4	0.9	20.1	1.16	15.9	5.1	
	3.2	0.7	1.7	19.2	14.5	0.93	22.5	20.5	3.2	0.7	1.7	20.9	1.16	16.8	5.3	
70	4.3	1.2	2.7	19.5	14.6	0.89	22.6	22.0	4.3	1.2	2.7	21.5	1.17	17.3	5.4	
	2.2	0.4	0.8	17.4	13.6	1.18	21.6	14.7	2.2	0.4	0.8	21.9	1.17	17.7	5.5	
	3.2	0.7	1.6	18.1	14.0	1.08	21.9	16.7	3.2	0.7	1.6	22.8	1.17	18.6	5.7	
80	4.3	1.1	2.6	18.5	14.2	1.03	22.1	18.0	4.3	1.1	2.6	23.4	1.18	19.2	5.8	
	2.2	0.3	0.8	16.1	13.0	1.35	20.9	12.0	2.2	0.3	0.8	23.6	1.23	19.4	5.6	
	3.2	0.7	1.5	16.9	13.4	1.25	21.3	13.6	3.2	0.7	1.5	24.6	1.23	20.4	5.8	
90	4.3	1.1	2.6	17.3	13.6	1.19	21.5	14.6	4.3	1.1	2.6	25.2	1.24	20.9	6.0	
	2.2	0.3	0.8	15.0	12.4	1.53	20.4	9.8	Operation Not Recommended							
	3.2	0.6	1.5	15.6	12.8	1.42	20.7	11.0								
4.3	1.1	2.5	16.1	13.0	1.36	20.9	11.8									
100	2.2	0.3	0.7	13.9	12.0	1.73	20.0	8.0								
	3.2	0.6	1.4	14.5	12.2	1.62	20.2	9.0								
	4.3	1.0	2.3	14.8	12.4	1.55	20.4	9.6								
110	2.2	0.2	0.5	13.0	11.7	1.95	19.9	6.7								
	3.2	0.5	1.1	13.4	11.8	1.83	19.9	7.4								
	4.3	0.9	2.0	13.8	11.9	1.76	20.0	7.8								

- Interpolation is permissible; extrapolation is not.
- All entering air conditions are 80°F (26.6°C) DB and 67°F (19.4°C) WB in cooling, and 70°F (21°C) DB in heating.
- AHRI/ISO certified conditions are 80.6°F (27°C) DB and 66.2°F (19°C) WB in cooling and 68°F (20°C) DB in heating.
- Table does not reflect fan or pump power corrections for AHRI/ISO conditions.
- All performance is based upon the lower voltage of dual voltage rated units.
- Performance stated is at the rated power supply; performance may vary as the power supply varies from the rated.
- Operation below 40°F (4.4°C) is based upon 20% methanol antifreeze solution.
- Operation below 60°F (15.5°C) EWT requires optional insulated water/refrigerant circuit.
- See performance correction tables for operating conditions other than those listed above.
- See Performance Data Selection Notes for operation in the shaded areas.
- For quiet operation and long term reliability, it is recommended that systems be designed to avoid continuous operation in the outlined areas.
- Performance capacities shown in thousands of Btuh

Performance Data SY*024 EC Blower Motor (Full Load)

Models:
SY
024-060

800 CFM Rated Airflow

EWT °F	GPM	WPD		COOLING - EAT 80/66.2 °F					GPM	WPD		HEATING - EAT 70°F				
		PSI	FT	TC	SC	KW	HR	EER		PSI	FT	HC	KW	HE	COP	
20	Operation Not Recommended									6.0	4.4	10.1	15.7	1.45	10.5	3.2
	3.0	1.3	3.1	27.8	19.6	1.08	31.5	25.6	3.0	1.3	3.1	17.4	1.48	12.1	3.4	
	4.5	2.4	5.6	27.6	19.3	1.02	31.1	27.0	4.5	2.4	5.6	18.2	1.49	12.9	3.6	
30	6.0	3.5	8.1	27.4	19.0	0.99	30.8	27.6	6.0	3.5	8.1	18.6	1.50	13.3	3.6	
	3.0	1.0	2.4	27.5	19.7	1.18	31.5	23.4	3.0	1.0	2.4	20.1	1.53	14.7	3.9	
	4.5	1.9	4.5	27.8	19.7	1.11	31.5	25.0	4.5	1.9	4.5	21.0	1.54	15.5	4.0	
40	6.0	2.9	6.6	27.8	19.6	1.08	31.5	25.7	6.0	2.9	6.6	21.5	1.55	16.0	4.1	
	3.0	0.8	1.9	26.8	19.4	1.23	31.2	21.8	3.0	0.8	1.9	22.8	1.58	17.2	4.2	
	4.5	1.6	3.7	27.3	19.7	1.16	31.5	23.6	4.5	1.6	3.7	23.9	1.60	18.2	4.4	
50	6.0	2.5	5.7	27.5	19.7	1.12	31.5	24.5	6.0	2.5	5.7	24.4	1.61	18.7	4.4	
	3.0	0.7	1.6	25.8	19.0	1.34	30.6	19.2	3.0	0.7	1.6	25.5	1.63	19.7	4.6	
	4.5	1.4	3.2	26.5	19.3	1.26	31.0	21.0	4.5	1.4	3.2	26.7	1.66	20.8	4.7	
60	6.0	2.2	5.1	26.8	19.5	1.22	31.2	21.9	6.0	2.2	5.1	27.4	1.67	21.4	4.8	
	3.0	0.6	1.5	24.5	18.3	1.49	29.8	16.5	3.0	0.6	1.5	28.1	1.69	22.1	4.9	
	4.5	1.3	3.0	25.4	18.8	1.39	30.3	18.3	4.5	1.3	3.0	29.5	1.72	23.4	5.0	
70	6.0	2.1	4.8	25.8	19.0	1.34	30.6	19.2	6.0	2.1	4.8	30.3	1.74	24.1	5.1	
	3.0	0.6	1.4	23.2	17.6	1.66	29.1	14.0	3.0	0.6	1.4	30.8	1.75	24.6	5.2	
	4.5	1.2	2.9	24.1	18.1	1.54	29.6	15.6	4.5	1.2	2.9	32.3	1.78	25.9	5.3	
80	6.0	2.0	4.6	24.5	18.3	1.49	29.8	16.5	6.0	2.0	4.6	33.1	1.80	26.7	5.4	
	3.0	0.6	1.4	21.8	17.0	1.87	28.5	11.7	3.0	0.6	1.4	33.4	1.89	27.0	5.2	
	4.5	1.2	2.8	22.7	17.4	1.73	28.9	13.1	4.5	1.2	2.8	35.0	1.93	28.5	5.3	
90	6.0	2.0	4.6	23.1	17.6	1.66	29.1	13.9	6.0	2.0	4.6	35.9	1.95	29.3	5.4	
	3.0	0.6	1.3	20.6	16.4	2.14	28.2	9.6	Operation Not Recommended							
	4.5	1.2	2.7	21.3	16.7	1.97	28.3	10.9								
6.0	1.9	4.5	21.8	16.9	1.89	28.5	11.5									
100	3.0	0.5	1.2	19.5	16.0	2.47	28.3	7.9								
	4.5	1.1	2.6	20.1	16.2	2.26	28.1	8.9								
	6.0	1.8	4.2	20.5	16.4	2.16	28.2	9.5								
110	3.0	0.4	1.0	18.8	16.0	2.89	29.0	6.5								
	4.5	0.9	2.2	19.2	16.0	2.61	28.5	7.3								
	6.0	1.6	3.8	19.4	16.0	2.49	28.3	7.8								

- Interpolation is permissible; extrapolation is not.
- All entering air conditions are 80°F (26.6°C) DB and 67°F (19.4°C) WB in cooling, and 70°F (21°C) DB in heating.
- AHRI/ISO certified conditions are 80.6°F (27°C) DB and 66.2°F (19°C) WB in cooling and 68°F (20°C) DB in heating.
- Table does not reflect fan or pump power corrections for AHRI/ISO conditions.
- All performance is based upon the lower voltage of dual voltage rated units.
- Performance stated is at the rated power supply; performance may vary as the power supply varies from the rated.
- Operation below 40°F (4.4°C) is based upon 20% methanol antifreeze solution.
- Operation below 60°F (15.5°C) EWT requires optional insulated water/refrigerant circuit.
- See performance correction tables for operating conditions other than those listed above.
- See Performance Data Selection Tables for operation in the shaded areas.
- For quiet operation and long term reliability, it is recommended that systems be designed to avoid continuous operation in the outlined areas.
- Performance capacities shown in thousands of Btuh

Performance Data SY*030 EC Blower Motor (Part Load)

Models:
SY
024-060

750 CFM Rated Airflow

EWT °F	GPM	WPD		COOLING - EAT 80/66.2 °F					GPM	WPD		HEATING - EAT 70°F									
		PSI	FT	TC	SC	KW	HR	EER		PSI	FT	HC	kW	HE	COP						
20	Operation Not Recommended								5.5	3.6	8.3	14.7	1.47	9.5	2.9						
	2.8	1.1	2.5	25.7	18.2	0.81	28.5	31.7	2.8	1.1	2.5	16.3	1.50	11.0	3.2						
	4.1	2.0	4.5	26.0	18.4	0.75	28.6	34.5	4.1	2.0	4.5	17.0	1.51	11.6	3.3						
30	5.5	2.9	6.6	26.1	18.5	0.73	28.6	35.8	5.5	2.9	6.6	17.3	1.51	12.0	3.4						
	2.8	0.8	1.8	25.1	18.0	0.92	28.2	27.3	2.8	0.8	1.8	18.7	1.53	13.2	3.6						
	4.1	1.5	3.5	25.5	18.2	0.85	28.4	30.2	4.1	1.5	3.5	19.4	1.54	13.9	3.7						
40	5.5	2.3	5.4	25.7	18.2	0.81	28.5	31.7	5.5	2.3	5.4	19.8	1.54	14.4	3.8						
	2.8	0.6	1.4	24.3	17.6	1.02	27.9	24.0	2.8	0.6	1.4	21.0	1.55	15.4	4.0						
	4.1	1.2	2.9	24.8	17.8	0.93	28.1	26.8	4.1	1.2	2.8	21.8	1.56	16.2	4.1						
50	5.5	2.0	4.6	25.1	18.0	0.88	28.2	28.4	5.5	2.0	4.6	22.3	1.56	16.7	4.2						
	2.8	0.5	1.1	23.4	17.2	1.17	27.6	20.0	2.8	0.5	1.1	23.2	1.57	17.6	4.3						
	4.1	1.1	2.4	24.0	17.5	1.07	27.8	22.4	4.1	1.1	2.4	24.1	1.57	18.5	4.5						
60	5.5	1.8	4.1	24.3	17.6	1.02	27.9	23.9	5.5	1.8	4.1	24.6	1.57	19.0	4.6						
	2.8	0.4	1.0	22.4	16.8	1.35	27.2	16.6	2.8	0.4	1.0	25.3	1.58	19.7	4.7						
	4.1	1.0	2.2	23.1	17.0	1.24	27.5	18.6	4.1	1.0	2.2	26.3	1.58	20.7	4.9						
70	5.5	1.7	3.8	23.4	17.2	1.18	27.6	19.9	5.5	1.7	3.8	26.9	1.58	21.3	5.0						
	2.8	0.4	0.9	21.3	16.3	1.55	26.8	13.7	2.8	0.4	0.9	27.4	1.59	21.8	5.1						
	4.1	0.9	2.1	22.0	16.6	1.43	27.1	15.4	4.1	0.9	2.1	28.5	1.60	22.8	5.2						
80	5.5	1.6	3.7	22.4	16.7	1.36	27.2	16.4	5.5	1.6	3.7	29.1	1.60	23.4	5.3						
	2.8	0.4	0.9	20.2	15.7	1.77	26.4	11.4	2.8	0.4	0.9	29.5	1.67	23.8	5.2						
	4.1	0.9	2.0	20.9	16.1	1.64	26.7	12.8	4.1	0.9	2.0	30.7	1.69	24.9	5.3						
90	5.5	1.6	3.6	21.3	16.2	1.56	26.8	13.6	5.5	1.6	3.6	31.3	1.70	25.5	5.4						
	2.8	0.4	0.9	18.9	15.2	2.01	26.1	9.4	Operation Not Recommended												
	4.1	0.9	2.0	19.7	15.5	1.86	26.3	10.6													
5.5	1.5	3.5	20.1	15.7	1.79	26.4	11.2														
100	2.8	0.3	0.8	17.7	14.6	2.26	25.7	7.8													
	4.1	0.8	1.8	18.4	14.9	2.11	25.9	8.7													
	5.5	1.4	3.2	18.8	15.1	2.03	26.0	9.3													
110	2.8	0.2	0.5	16.4	14.0	2.52	25.4	6.5													
	4.1	0.6	1.5	17.2	14.3	2.37	25.6	7.2													
	5.5	1.2	2.7	17.6	14.5	2.28	25.7	7.7													
120																					

- Interpolation is permissible; extrapolation is not.
- All entering air conditions are 80°F (26.6°C) DB and 67°F (19.4°C) WB in cooling, and 70°F (21°C) DB in heating.
- AHRI/ISO certified conditions are 80.6°F (27°C) DB and 66.2°F (19°C) WB in cooling and 68°F (20°C) DB in heating.
- Table does not reflect fan or pump power corrections for AHRI/ISO conditions.
- All performance is based upon the lower voltage of dual voltage rated units.
- Performance stated is at the rated power supply; performance may vary as the power supply varies from the rated.
- Operation below 40°F (4.4°C) is based upon 20% methanol antifreeze solution.
- Operation below 60°F (15.5°C) EWT requires optional insulated water/refrigerant circuit.
- See performance correction tables for operating conditions other than those listed above.
- See Performance Data Selection Notes for operation in the shaded areas.
- For quiet operation and long term reliability, it is recommended that systems be designed to avoid continuous operation in the outlined areas.
- Performance capacities shown in thousands of Btuh

Performance Data SY*030 EC Blower Motor (Full Load)

Models:
SY
024-060

900 CFM Rated Airflow

EWT °F	GPM	WPD		COOLING - EAT 80/66.2 °F					GPM	WPD		HEATING - EAT 70°F			
		PSI	FT	TC	SC	KW	HR	EER		PSI	FT	HC	kW	HE	COP
20	Operation Not Recommended								7.5	6.0	13.8	20.9	1.93	14.0	3.2
	3.8	1.8	4.1	34.3	23.2	1.39	39.1	24.8	3.8	1.8	4.1	22.8	1.98	15.8	3.4
30	5.6	3.3	7.5	34.8	23.4	1.31	39.2	26.5	5.6	3.3	7.5	23.6	2.01	16.5	3.5
	7.5	4.8	11.0	35.0	23.5	1.28	39.3	27.4	7.5	4.8	11.0	24.1	2.02	16.9	3.5
40	3.8	1.3	3.1	33.5	22.8	1.51	38.7	22.1	3.8	1.3	3.1	25.8	2.07	18.5	3.7
	5.6	2.6	5.9	34.1	23.1	1.43	39.0	23.9	5.6	2.6	5.9	26.8	2.10	19.3	3.7
50	7.5	3.9	9.0	34.3	23.2	1.38	39.1	24.8	7.5	3.9	9.0	27.4	2.11	19.8	3.8
	3.8	1.0	2.4	32.6	22.4	1.60	38.3	20.4	3.8	1.0	2.4	28.8	2.15	21.2	3.9
60	5.6	2.1	4.8	33.2	22.7	1.50	38.6	22.1	5.6	2.1	4.8	29.9	2.19	22.2	4.0
	7.5	3.3	7.6	33.6	22.8	1.45	38.7	23.1	7.5	3.3	7.6	30.6	2.20	22.8	4.1
70	3.8	0.9	2.0	31.5	22.0	1.77	37.8	17.8	3.8	0.9	2.0	31.8	2.24	23.9	4.2
	5.6	1.8	4.2	32.2	22.3	1.66	38.1	19.4	5.6	1.8	4.2	33.1	2.27	25.0	4.3
80	7.5	3.0	6.8	32.6	22.4	1.60	38.3	20.3	7.5	3.0	6.8	33.8	2.29	25.6	4.3
	3.8	0.8	1.8	30.3	21.5	1.97	37.3	15.4	3.8	0.8	1.8	34.8	2.32	26.5	4.4
90	5.6	1.7	3.8	31.1	21.8	1.84	37.6	16.9	5.6	1.7	3.8	36.1	2.36	27.7	4.5
	7.5	2.8	6.4	31.5	22.0	1.78	37.8	17.7	7.5	2.8	6.4	36.9	2.38	28.5	4.5
100	3.8	0.7	1.7	28.9	20.9	2.20	36.8	13.1	3.8	0.7	1.7	37.7	2.40	29.1	4.6
	5.6	1.6	3.7	29.8	21.3	2.05	37.1	14.5	5.6	1.6	3.7	39.1	2.45	30.4	4.7
110	7.5	2.7	6.3	30.2	21.4	1.98	37.3	15.3	7.5	2.7	6.3	40.0	2.47	31.2	4.7
	3.8	0.7	1.7	27.5	20.3	2.46	36.2	11.2	3.8	0.7	1.7	40.5	2.59	31.7	4.6
120	5.6	1.6	3.7	28.4	20.7	2.30	36.6	12.4	5.6	1.6	3.6	42.0	2.63	33.1	4.7
	7.5	2.7	6.2	28.9	20.9	2.21	36.7	13.1	7.5	2.7	6.2	42.9	2.66	33.8	4.7
130	3.8	0.7	1.7	25.9	19.6	2.76	35.7	9.4	Operation Not Recommended						
	5.6	1.5	3.6	26.9	20.0	2.57	36.0	10.4							
140	7.5	2.6	6.1	27.4	20.2	2.48	36.2	11.0							
	3.8	0.7	1.5	24.3	18.8	3.10	35.3	7.8							
150	5.6	1.4	3.3	25.3	19.3	2.89	35.6	8.7							
	7.5	2.5	5.8	25.8	19.5	2.78	35.7	9.3							
160	3.8	0.5	1.2	22.6	17.9	3.48	34.9	6.5							
	5.6	1.2	2.9	23.6	18.4	3.25	35.1	7.3							
170	7.5	2.2	5.1	24.1	18.7	3.13	35.3	7.7							

- Interpolation is permissible; extrapolation is not.
- All entering air conditions are 80°F (26.6°C) DB and 67°F (19.4°C) WB in cooling, and 70°F (21°C) DB in heating.
- AHRI/ISO certified conditions are 80.6°F (27°C) DB and 66.2°F (19°C) WB in cooling and 68°F (20°C) DB in heating.
- Table does not reflect fan or pump power corrections for AHRI/ISO conditions.
- All performance is based upon the lower voltage of dual voltage rated units.
- Performance stated is at the rated power supply; performance may vary as the power supply varies from the rated.
- Operation below 40°F (4.4°C) is based upon 20% methanol antifreeze solution.
- Operation below 60°F (15.5°C) EWT requires optional insulated water/refrigerant circuit.
- See performance correction tables for operating conditions other than those listed above.
- See Performance Data Selection Notes for operation in the shaded areas.
- For quiet operation and long term reliability, it is recommended that systems be designed to avoid continuous operation in the outlined areas.
- Performance capacities shown in thousands of Btuh

Performance Data SY*036 EC Blower Motor (Part Load)

Models:
SY
024-060

950 CFM Rated Airflow

EWT °F	GPM	WPD		COOLING - EAT 80/66.2 °F					GPM	WPD		HEATING - EAT 70°F			
		PSI	FT	TC	SC	KW	HR	EER		PSI	FT	HC	kW	HE	COP
20	Operation Not Recommended								6.8	3.3	7.7	17.3	1.67	11.3	3.0
	3.4	1.0	2.3	31.0	22.7	1.02	34.5	30.5	3.4	1.0	2.3	19.2	1.70	13.1	3.3
30	5.1	1.9	4.3	31.3	22.7	0.96	34.6	32.7	5.1	1.9	4.3	19.9	1.71	13.9	3.4
	6.8	2.8	6.5	31.4	22.6	0.93	34.6	33.7	6.8	2.8	6.5	20.4	1.71	14.3	3.5
40	3.4	0.8	1.9	30.4	22.4	1.13	34.2	26.9	3.4	0.8	1.9	22.1	1.73	15.9	3.7
	5.1	1.6	3.6	30.8	22.6	1.05	34.4	29.3	5.1	1.6	3.6	23.1	1.74	16.9	3.9
50	6.8	2.4	5.6	31.0	22.7	1.02	34.5	30.5	6.8	2.4	5.6	23.6	1.75	17.4	4.0
	3.4	0.7	1.7	29.4	22.0	1.21	33.7	24.3	3.4	0.7	1.7	25.1	1.76	18.9	4.2
60	5.1	1.4	3.1	30.1	22.3	1.12	34.1	26.8	5.1	1.4	3.1	26.4	1.77	20.1	4.4
	6.8	2.1	4.9	30.4	22.4	1.08	34.2	28.1	6.8	2.1	4.9	27.0	1.78	20.7	4.5
70	3.4	0.7	1.6	28.3	21.4	1.36	33.2	20.8	3.4	0.7	1.6	28.3	1.79	21.9	4.6
	5.1	1.2	2.8	29.1	21.8	1.26	33.6	23.0	5.1	1.2	2.8	29.7	1.80	23.3	4.8
80	6.8	1.9	4.5	29.4	22.0	1.21	33.7	24.3	6.8	1.9	4.5	30.5	1.80	24.1	5.0
	3.4	0.6	1.5	27.0	20.8	1.54	32.5	17.6	3.4	0.6	1.5	31.4	1.81	25.0	5.1
90	5.1	1.2	2.7	27.9	21.2	1.42	32.9	19.6	5.1	1.2	2.7	33.1	1.82	26.6	5.3
	6.8	1.8	4.2	28.3	21.4	1.37	33.1	20.7	6.8	1.8	4.2	34.0	1.83	27.4	5.4
100	3.4	0.6	1.4	25.6	20.1	1.74	31.8	14.7	3.4	0.6	1.4	34.6	1.84	28.0	5.5
	5.1	1.1	2.6	26.5	20.5	1.61	32.2	16.5	5.1	1.1	2.6	36.4	1.85	29.8	5.8
110	6.8	1.7	4.0	27.0	20.7	1.55	32.5	17.4	6.8	1.7	4.0	37.3	1.86	30.7	5.9
	3.4	0.6	1.4	24.1	19.4	1.96	31.1	12.3	3.4	0.6	1.4	37.6	1.94	31.0	5.7
120	5.1	1.1	2.5	25.1	19.8	1.82	31.5	13.8	5.1	1.1	2.5	39.6	1.96	32.9	5.9
	6.8	1.7	3.9	25.5	20.1	1.75	31.7	14.6	6.8	1.7	3.9	40.6	1.98	33.9	6.0
130	3.4	0.6	1.4	22.6	18.8	2.20	30.4	10.2	Operation Not Recommended						
	5.1	1.1	2.5	23.5	19.2	2.05	30.8	11.5							
140	6.8	1.7	3.9	24.0	19.4	1.98	31.0	12.1							
	3.4	0.6	1.3	21.0	18.3	2.47	29.8	8.5							
150	5.1	1.0	2.4	21.9	18.6	2.31	30.2	9.5							
	6.8	1.6	3.8	22.4	18.7	2.23	30.3	10.0							
160	3.4	0.5	1.3	19.5	17.8	2.77	29.3	7.0							
	5.1	1.0	2.2	20.4	18.1	2.59	29.6	7.9							
170	6.8	1.5	3.6	20.8	18.2	2.51	29.8	8.3							

- Interpolation is permissible; extrapolation is not.
- All entering air conditions are 80°F (26.6°C) DB and 67°F (19.4°C) WB in cooling, and 70°F (21°C) DB in heating.
- AHRI/ISO certified conditions are 80.6°F (27°C) DB and 66.2°F (19°C) WB in cooling and 68°F (20°C) DB in heating.
- Table does not reflect fan or pump power corrections for AHRI/ISO conditions.
- All performance is based upon the lower voltage of dual voltage rated units.
- Performance stated is at the rated power supply; performance may vary as the power supply varies from the rated.
- Operation below 40°F (4.4°C) is based upon 20% methanol antifreeze solution.
- Operation below 60°F (15.5°C) EWT requires optional insulated water/refrigerant circuit.
- See performance correction tables for operating conditions other than those listed above.
- See Performance Data Selection Notes for operation in the shaded areas.
- For quiet operation and long term reliability, it is recommended that systems be designed to avoid continuous operation in the outlined areas.
- Performance capacities shown in thousands of Btuh

Performance Data SY*036 EC Blower Motor (Full Load)

Models:
SY
024-060

1150 CFM Rated Airflow

EWT °F	GPM	WPD		COOLING - EAT 80/66.2 °F					GPM	WPD		HEATING - EAT 70°F									
		PSI	FT	TC	SC	KW	HR	EER		PSI	FT	HC	kW	HE	COP						
20	Operation Not Recommended									9.0	5.2	12.1	25.1	2.26	17.0	3.3					
	4.5	1.6	3.6	40.6	28.9	1.74	46.8	23.3	4.5	1.6	3.6	27.4	2.32	19.2	3.5						
	6.8	3.0	6.8	41.1	29.3	1.70	47.2	24.2	6.8	3.0	6.8	28.6	2.35	20.3	3.6						
30	9.0	4.4	10.1	41.3	29.6	1.69	47.4	24.5	9.0	4.4	10.1	29.2	2.36	20.8	3.6						
	4.5	1.3	3.0	39.7	28.2	1.83	46.2	21.6	4.5	1.3	3.0	31.4	2.42	22.8	3.8						
	6.8	2.4	5.5	40.4	28.7	1.77	46.6	22.9	6.8	2.4	5.5	32.9	2.46	24.1	3.9						
40	9.0	3.7	8.6	40.6	28.9	1.74	46.8	23.4	9.0	3.7	8.6	33.7	2.48	24.8	4.0						
	4.5	1.1	2.6	38.6	27.4	1.96	45.6	19.7	4.5	1.1	2.6	35.5	2.53	26.5	4.1						
	6.8	2.0	4.7	39.4	27.9	1.87	46.0	21.1	6.8	2.0	4.7	37.3	2.58	28.1	4.2						
50	9.0	3.3	7.6	39.7	28.2	1.83	46.3	21.7	9.0	3.3	7.6	38.2	2.60	29.0	4.3						
	4.5	1.0	2.4	37.4	26.7	2.13	45.0	17.5	4.5	1.0	2.4	39.7	2.64	30.4	4.4						
	6.8	1.8	4.2	38.2	27.2	2.01	45.4	19.0	6.8	1.8	4.2	41.8	2.70	32.2	4.5						
60	9.0	3.0	6.9	38.6	27.4	1.96	45.6	19.7	9.0	3.0	6.9	42.9	2.73	33.2	4.6						
	4.5	1.0	2.2	35.9	26.0	2.34	44.3	15.4	4.5	1.0	2.2	44.0	2.77	34.2	4.7						
	6.8	1.7	4.0	36.9	26.4	2.20	44.7	16.8	6.8	1.7	4.0	46.3	2.84	36.3	4.8						
70	9.0	2.8	6.5	37.4	26.7	2.13	45.0	17.5	9.0	2.8	6.5	47.6	2.88	37.3	4.8						
	4.5	0.9	2.1	34.4	25.3	2.58	43.6	13.3	4.5	0.9	2.1	48.3	2.90	38.0	4.9						
	6.8	1.7	4.0	35.4	25.7	2.42	44.0	14.7	6.8	1.7	4.0	50.8	2.99	40.2	5.0						
80	9.0	2.7	6.3	35.9	25.9	2.34	44.2	15.3	9.0	2.7	6.3	52.1	3.04	41.3	5.0						
	4.5	0.9	2.1	32.7	24.6	2.86	42.8	11.4	4.5	0.9	2.1	52.5	3.05	41.6	5.0						
	6.8	1.7	3.9	33.8	25.0	2.67	43.3	12.6	6.8	1.7	3.9	55.2	3.15	44.0	5.1						
90	9.0	2.7	6.2	34.3	25.2	2.59	43.5	13.3	9.0	2.7	6.2	56.6	3.21	45.2	5.2						
	4.5	0.9	2.1	30.8	24.0	3.18	42.1	9.7	Operation Not Recommended												
	6.8	1.7	3.9	32.0	24.4	2.97	42.6	10.8													
9.0	2.7	6.1	32.6	24.6	2.88	42.8	11.3														
100	4.5	0.9	2.0	28.9	23.3	3.53	41.4	8.2													
	6.8	1.6	3.6	30.1	23.7	3.30	41.8	9.1													
	9.0	2.6	5.9	30.7	23.9	3.20	42.1	9.6													
110	4.5	0.8	1.8	26.8	22.7	3.91	40.7	6.8													
	6.8	1.4	3.1	28.1	23.1	3.67	41.1	7.6													
	9.0	2.4	5.6	28.7	23.3	3.56	41.3	8.1													
120																					

- Interpolation is permissible; extrapolation is not.
- All entering air conditions are 80°F (26.6°C) DB and 67°F (19.4°C) WB in cooling, and 70°F (21°C) DB in heating.
- AHRI/ISO certified conditions are 80.6°F (27°C) DB and 66.2°F (19°C) WB in cooling and 68°F (20°C) DB in heating.
- Table does not reflect fan or pump power corrections for AHRI/ISO conditions.
- All performance is based upon the lower voltage of dual voltage rated units.
- Performance stated is at the rated power supply; performance may vary as the power supply varies from the rated.
- Operation below 40°F (4.4°C) is based upon 20% methanol antifreeze solution.
- Operation below 60°F (15.5°C) EWT requires optional insulated water/refrigerant circuit.
- See performance correction tables for operating conditions other than those listed above.
- See Performance Data Selection Notes for operation in the shaded areas.
- For quiet operation and long term reliability, it is recommended that systems be designed to avoid continuous operation in the outlined areas.
- Performance capacities shown in thousands of Btuh

Performance Data SY*042 EC Blower Motor (Part Load)

Models:
SY
024-060

1050 CFM Rated Airflow

EWT °F	GPM	WPD		COOLING - EAT 80/66.2 °F					GPM	WPD		HEATING - EAT 70°F									
		PSI	FT	TC	SC	KW	HR	EER		PSI	FT	HC	kW	HE	COP						
20	Operation Not Recommended								8.5	3.3	7.7	19.2	2.06	11.9	2.7						
	4.3	0.9	2.2	34.3	24.1	1.18	38.3	29.0	4.3	0.9	2.2	21.4	2.09	14.0	3.0						
	6.4	1.9	4.3	32.9	22.5	1.11	36.7	29.5	6.4	1.9	4.3	22.2	2.10	14.7	3.1						
30	8.5	3.0	6.9	32.0	21.6	1.09	35.7	29.4	8.5	3.0	6.9	22.6	2.10	15.1	3.2						
	4.3	0.9	2.0	35.6	25.7	1.33	40.2	26.8	4.3	0.9	2.0	24.9	2.12	17.4	3.4						
	6.4	1.7	3.9	35.0	24.8	1.23	39.2	28.3	6.4	1.7	3.9	26.0	2.13	18.4	3.6						
40	8.5	2.8	6.4	34.5	24.3	1.19	38.5	28.9	8.5	2.8	6.4	26.6	2.14	19.0	3.6						
	4.3	0.8	1.9	35.9	26.4	1.45	41.0	24.8	4.3	0.8	1.9	28.7	2.15	21.1	3.9						
	6.4	1.6	3.7	35.8	26.0	1.33	40.6	26.9	6.4	1.6	3.7	30.1	2.16	22.4	4.1						
50	8.5	2.6	6.0	35.7	25.8	1.28	40.2	27.8	8.5	2.6	6.0	30.9	2.16	23.2	4.2						
	4.3	0.8	1.9	35.3	26.3	1.66	41.2	21.3	4.3	0.8	1.9	32.6	2.18	24.9	4.4						
	6.4	1.6	3.6	35.8	26.4	1.52	41.2	23.6	6.4	1.6	3.6	34.3	2.19	26.5	4.6						
60	8.5	2.5	5.8	35.9	26.4	1.46	41.1	24.6	8.5	2.5	5.8	35.1	2.19	27.4	4.7						
	4.3	0.8	1.9	34.1	25.8	1.89	40.9	18.0	4.3	0.8	1.9	36.5	2.20	28.7	4.9						
	6.4	1.5	3.5	35.0	26.2	1.74	41.1	20.1	6.4	1.5	3.5	38.2	2.21	30.4	5.1						
70	8.5	2.4	5.6	35.3	26.3	1.66	41.2	21.2	8.5	2.4	5.6	39.1	2.21	31.3	5.2						
	4.3	0.8	1.9	32.5	24.9	2.16	40.2	15.0	4.3	0.8	1.9	40.0	2.22	32.1	5.3						
	6.4	1.5	3.5	33.6	25.5	1.99	40.7	16.9	6.4	1.5	3.5	41.8	2.23	33.8	5.5						
80	8.5	2.4	5.5	34.1	25.7	1.90	40.8	17.9	8.5	2.4	5.5	42.6	2.24	34.6	5.6						
	4.3	0.8	1.9	30.6	23.9	2.46	39.3	12.4	4.3	0.8	1.9	43.1	2.34	35.1	5.4						
	6.4	1.5	3.4	31.8	24.6	2.27	39.9	14.0	6.4	1.5	3.4	44.5	2.36	36.5	5.5						
90	8.5	2.3	5.4	32.4	24.9	2.18	40.1	14.9	8.5	2.3	5.4	45.2	2.37	37.1	5.6						
	4.3	0.8	1.8	28.4	22.9	2.78	38.3	10.2	Operation Not Recommended												
	6.4	1.4	3.3	29.8	23.5	2.58	38.9	11.5													
8.5	2.3	5.2	30.4	23.8	2.48	39.2	12.3														
100	4.3	0.7	1.7	26.2	21.9	3.14	37.4	8.3													
	6.4	1.3	3.1	27.5	22.5	2.92	37.9	9.4													
	8.5	2.1	5.0	28.2	22.8	2.82	38.2	10.0													
110	4.3	0.6	1.4	24.0	21.1	3.54	36.6	6.8													
	6.4	1.2	2.7	25.3	21.6	3.30	37.0	7.7													
	8.5	2.0	4.5	25.9	21.8	3.19	37.3	8.1													
120																					

- Interpolation is permissible; extrapolation is not.
- All entering air conditions are 80°F (26.6°C) DB and 67°F (19.4°C) WB in cooling, and 70°F (21°C) DB in heating.
- AHRI/ISO certified conditions are 80.6°F (27°C) DB and 66.2°F (19°C) WB in cooling and 68°F (20°C) DB in heating.
- Table does not reflect fan or pump power corrections for AHRI/ISO conditions.
- All performance is based upon the lower voltage of dual voltage rated units.
- Performance stated is at the rated power supply; performance may vary as the power supply varies from the rated.
- Operation below 40°F (4.4°C) is based upon 20% methanol antifreeze solution.
- Operation below 60°F (15.5°C) EWT requires optional insulated water/refrigerant circuit.
- See performance correction tables for operating conditions other than those listed above.
- See Performance Data Selection Notes for operation in the shaded areas.
- For quiet operation and long term reliability, it is recommended that systems be designed to avoid continuous operation in the outlined areas.
- Performance capacities shown in thousands of Btuh

Performance Data SY*042 EC Blower Motor (Full Load)

Models:
SY
024-060

1350 CFM Rated Airflow

EWT °F	GPM	WPD		COOLING - EAT 80/66.2 °F					GPM	WPD		HEATING - EAT 70°F			
		PSI	FT	TC	SC	KW	HR	EER		PSI	FT	HC	kW	HE	COP
20	Operation Not Recommended								10.5	4.9	11.2	27.7	2.78	17.8	2.9
30	5.3	1.4	3.1	44.1	29.7	1.96	50.8	22.5	5.3	1.4	3.1	30.1	2.85	19.9	3.1
	7.9	2.7	6.3	42.2	27.9	1.84	48.4	23.0	7.9	2.7	6.3	31.1	2.87	20.9	3.2
	10.5	4.3	10.0	41.1	26.9	1.78	47.1	23.1	10.5	4.3	10.0	31.7	2.88	21.5	3.2
40	5.3	1.2	2.9	45.9	31.6	2.16	53.3	21.3	5.3	1.2	2.9	34.3	2.93	23.9	3.4
	7.9	2.5	5.7	44.9	30.5	2.02	51.8	22.2	7.9	2.5	5.7	35.8	2.96	25.3	3.6
	10.5	4.0	9.2	44.2	29.8	1.96	50.9	22.5	10.5	4.0	9.2	36.7	2.97	26.1	3.6
50	5.3	1.2	2.7	46.5	32.5	2.27	54.6	20.5	5.3	1.2	2.7	39.1	3.01	28.4	3.8
	7.9	2.3	5.3	46.2	32.0	2.13	53.8	21.7	7.9	2.3	5.3	41.0	3.04	30.2	4.0
	10.5	3.7	8.6	45.9	31.6	2.07	53.2	22.2	10.5	3.7	8.6	42.1	3.06	31.2	4.0
60	5.3	1.1	2.6	46.2	32.6	2.50	55.1	18.5	5.3	1.1	2.6	44.1	3.09	33.1	4.2
	7.9	2.2	5.1	46.5	32.6	2.34	54.8	19.9	7.9	2.2	5.1	46.4	3.13	35.3	4.4
	10.5	3.6	8.2	46.5	32.5	2.26	54.6	20.5	10.5	3.6	8.2	47.7	3.15	36.5	4.4
70	5.3	1.1	2.6	45.1	32.1	2.77	54.9	16.3	5.3	1.1	2.6	49.2	3.17	37.9	4.5
	7.9	2.1	4.9	45.9	32.5	2.58	55.1	17.8	7.9	2.1	4.9	51.7	3.22	40.3	4.7
	10.5	3.5	8.0	46.2	32.6	2.49	55.1	18.6	10.5	3.5	8.0	53.1	3.25	41.5	4.8
80	5.3	1.1	2.6	43.5	31.2	3.08	54.4	14.1	5.3	1.1	2.6	54.1	3.27	42.4	4.8
	7.9	2.1	4.9	44.7	31.9	2.85	54.8	15.7	7.9	2.1	4.9	56.7	3.33	44.8	5.0
	10.5	3.4	7.8	45.2	32.1	2.75	55.0	16.4	10.5	3.4	7.8	58.0	3.36	46.0	5.1
90	5.3	1.1	2.6	41.4	30.2	3.45	53.6	12.0	5.3	1.1	2.6	58.5	3.52	46.5	4.9
	7.9	2.1	4.8	42.9	30.9	3.18	54.2	13.5	7.9	2.1	4.8	60.9	3.60	48.6	5.0
	10.5	3.3	7.7	43.5	31.3	3.07	54.4	14.2	10.5	3.3	7.7	62.0	3.65	49.5	5.0
100	5.3	1.1	2.5	38.9	28.9	3.88	52.7	10.0	Operation Not Recommended						
	7.9	2.0	4.6	40.6	29.8	3.58	53.3	11.4							
	10.5	3.2	7.5	41.4	30.2	3.44	53.6	12.0							
110	5.3	1.0	2.3	36.3	27.7	4.40	51.9	8.2							
	7.9	1.9	4.4	38.1	28.5	4.05	52.5	9.4							
	10.5	3.1	7.1	39.0	28.9	3.88	52.7	10.0							
120	5.3	0.8	1.9	33.5	26.5	5.01	51.3	6.7							
	7.9	1.7	3.9	35.4	27.3	4.60	51.7	7.7							
	10.5	2.9	6.6	36.3	27.7	4.41	51.9	8.2							

- Interpolation is permissible; extrapolation is not.
- All entering air conditions are 80°F (26.6°C) DB and 67°F (19.4°C) WB in cooling, and 70°F (21°C) DB in heating.
- AHRI/ISO certified conditions are 80.6°F (27°C) DB and 66.2°F (19°C) WB in cooling and 68°F (20°C) DB in heating.
- Table does not reflect fan or pump power corrections for AHRI/ISO conditions.
- All performance is based upon the lower voltage of dual voltage rated units.
- Performance stated is at the rated power supply; performance may vary as the power supply varies from the rated.
- Operation below 40°F (4.4°C) is based upon 20% methanol antifreeze solution.
- Operation below 60°F (15.5°C) EWT requires optional insulated water/refrigerant circuit.
- See performance correction tables for operating conditions other than those listed above.
- See Performance Data Selection Notes for operation in the shaded areas.
- For quiet operation and long term reliability, it is recommended that systems be designed to avoid continuous operation in the outlined areas.
- Performance capacities shown in thousands of Btuh

Performance Data SY*048 EC Blower Motor (Part Load)

Models:
SY
024-060

1250 CFM Rated Airflow

EWT °F	GPM	WPD		COOLING - EAT 80/66.2 °F					GPM	WPD		HEATING - EAT 70°F			
		PSI	FT	TC	SC	KW	HR	EER		PSI	FT	HC	kW	HE	COP
20	Operation Not Recommended								8.5	2.7	6.2	22.0	2.19	14.2	2.9
	4.2	0.6	1.5	39.3	29.7	1.23	43.5	31.9	4.2	0.6	1.5	24.2	2.19	16.4	3.2
	6.3	1.5	3.6	39.2	29.6	1.12	43.0	35.0	6.3	1.5	3.6	25.2	2.19	17.4	3.4
30	8.5	2.5	5.8	39.1	29.4	1.07	42.7	36.5	8.5	2.5	5.8	25.7	2.20	17.9	3.4
	4.2	0.6	1.5	38.9	29.7	1.41	43.7	27.5	4.2	0.6	1.5	27.9	2.22	20.0	3.7
	6.3	1.4	3.3	39.2	29.8	1.29	43.6	30.5	6.3	1.4	3.3	29.2	2.23	21.2	3.8
40	8.5	2.4	5.5	39.3	29.7	1.23	43.5	32.1	8.5	2.4	5.5	29.9	2.24	21.9	3.9
	4.2	0.6	1.5	38.0	29.5	1.56	43.6	24.4	4.2	0.6	1.5	31.8	2.27	23.7	4.1
	6.3	1.3	3.1	38.7	29.7	1.42	43.7	27.3	6.3	1.3	3.1	33.3	2.29	25.2	4.3
50	8.5	2.3	5.2	38.9	29.7	1.35	43.7	28.9	8.5	2.3	5.2	34.2	2.30	26.1	4.4
	4.2	0.7	1.5	36.8	29.0	1.78	43.1	20.7	4.2	0.7	1.5	35.7	2.32	27.5	4.5
	6.3	1.2	2.9	37.7	29.4	1.62	43.4	23.2	6.3	1.2	2.9	37.6	2.35	29.2	4.7
60	8.5	2.2	5.0	38.1	29.5	1.55	43.6	24.6	8.5	2.2	5.0	38.6	2.36	30.2	4.8
	4.2	0.7	1.6	35.1	28.4	2.03	42.3	17.3	4.2	0.7	1.6	39.7	2.38	31.2	4.9
	6.3	1.2	2.7	36.3	28.9	1.86	42.9	19.5	6.3	1.2	2.7	41.7	2.40	33.2	5.1
70	8.5	2.1	4.8	36.8	29.1	1.77	43.1	20.8	8.5	2.1	4.8	42.8	2.41	34.2	5.2
	4.2	0.7	1.6	33.2	27.7	2.30	41.4	14.4	4.2	0.7	1.6	43.4	2.41	34.9	5.3
	6.3	1.1	2.6	34.5	28.2	2.11	42.0	16.3	6.3	1.1	2.6	45.5	2.42	36.9	5.5
80	8.5	2.0	4.6	35.2	28.4	2.02	42.3	17.4	8.5	2.0	4.6	46.5	2.42	37.9	5.6
	4.2	0.7	1.5	31.1	26.7	2.60	40.3	11.9	4.2	0.7	1.5	46.8	2.52	38.2	5.4
	6.3	1.1	2.5	32.5	27.4	2.40	41.0	13.5	6.3	1.1	2.5	48.7	2.50	40.2	5.7
90	8.5	1.9	4.4	33.2	27.6	2.30	41.4	14.4	8.5	1.9	4.4	49.7	2.48	41.2	5.9
	4.2	0.6	1.4	28.8	25.7	2.93	39.2	9.8	Operation Not Recommended						
	6.3	1.1	2.5	30.2	26.4	2.72	39.9	11.1							
8.5	1.8	4.2	31.0	26.7	2.61	40.3	11.9								
110	4.2	0.5	1.2	26.3	24.5	3.30	38.0	8.0							
	6.3	1.0	2.4	27.8	25.3	3.07	38.7	9.1							
	8.5	1.7	4.0	28.6	25.6	2.96	39.1	9.7							
120	4.2	0.4	0.9	23.7	23.2	3.69	36.8	6.4							
	6.3	1.0	2.3	25.3	24.0	3.45	37.5	7.3							
	8.5	1.7	3.9	26.1	24.4	3.33	37.9	7.8							

- Interpolation is permissible; extrapolation is not.
- All entering air conditions are 80°F (26.6°C) DB and 67°F (19.4°C) WB in cooling, and 70°F (21°C) DB in heating.
- AHRI/ISO certified conditions are 80.6°F (27°C) DB and 66.2°F (19°C) WB in cooling and 68°F (20°C) DB in heating.
- Table does not reflect fan or pump power corrections for AHRI/ISO conditions.
- All performance is based upon the lower voltage of dual voltage rated units.
- Performance stated is at the rated power supply; performance may vary as the power supply varies from the rated.
- Operation below 40°F (4.4°C) is based upon 20% methanol antifreeze solution.
- Operation below 60°F (15.5°C) EWT requires optional insulated water/refrigerant circuit.
- See performance correction tables for operating conditions other than those listed above.
- See Performance Data Selection Notes for operation in the shaded areas.
- For quiet operation and long term reliability, it is recommended that systems be designed to avoid continuous operation in the outlined areas.
- Performance capacities shown in thousands of Btu/h

Performance Data SY*048 EC Blower Motor (Full Load)

Models:
SY
024-060

1550 CFM Rated Airflow

EWT °F	GPM	WPD		COOLING - EAT 80/66.2 °F					GPM	WPD		HEATING - EAT 70°F			
		PSI	FT	TC	SC	KW	HR	EER		PSI	FT	HC	kW	HE	COP
20	Operation Not Recommended								12.0	5.2	12.1	33.3	3.03	22.5	3.2
	6.0	1.4	3.2	52.9	38.7	2.09	60.1	25.3	6.0	1.4	3.2	36.5	3.13	25.4	3.4
	9.0	3.0	6.8	52.8	38.9	1.85	59.1	28.5	9.0	3.0	6.8	37.9	3.17	26.7	3.5
30	12.0	4.9	11.3	52.6	39.0	1.72	58.5	30.6	12.0	4.9	11.3	38.7	3.19	27.4	3.6
	6.0	1.3	3.0	52.6	38.3	2.39	60.7	22.0	6.0	1.3	3.0	41.3	3.26	29.8	3.7
	9.0	2.8	6.4	52.9	38.5	2.20	60.4	24.1	9.0	2.8	6.4	43.0	3.30	31.3	3.8
40	12.0	4.6	10.6	52.9	38.7	2.09	60.1	25.3	12.0	4.6	10.6	43.9	3.32	32.0	3.9
	6.0	1.2	2.9	51.6	37.8	2.54	60.6	20.3	6.0	1.2	2.9	46.0	3.37	34.0	4.0
	9.0	2.6	6.0	52.3	38.1	2.38	60.7	22.0	9.0	2.6	6.0	47.8	3.42	35.7	4.1
50	12.0	4.4	10.1	52.6	38.3	2.29	60.7	22.9	12.0	4.4	10.1	48.8	3.44	36.6	4.2
	6.0	1.2	2.7	50.1	37.3	2.77	60.0	18.1	6.0	1.2	2.7	50.5	3.48	38.2	4.3
	9.0	2.4	5.6	51.2	37.7	2.61	60.4	19.6	9.0	2.4	5.6	52.5	3.52	40.0	4.4
60	12.0	4.2	9.6	51.6	37.9	2.53	60.6	20.4	12.0	4.2	9.6	53.6	3.55	41.0	4.4
	6.0	1.1	2.6	48.3	36.7	3.01	59.0	16.0	6.0	1.1	2.6	55.0	3.58	42.3	4.5
	9.0	2.3	5.4	49.6	37.1	2.85	59.7	17.4	9.0	2.3	5.4	57.3	3.63	44.4	4.6
70	12.0	4.0	9.2	50.1	37.3	2.77	60.0	18.1	12.0	4.0	9.2	58.5	3.66	45.5	4.7
	6.0	1.1	2.5	46.2	35.9	3.30	57.9	14.0	6.0	1.1	2.4	59.6	3.69	46.5	4.7
	9.0	2.2	5.2	47.6	36.5	3.11	58.6	15.3	9.0	2.2	5.2	62.1	3.75	48.8	4.9
80	12.0	3.8	8.8	48.3	36.7	3.02	59.0	16.0	12.0	3.8	8.8	63.5	3.79	50.1	4.9
	6.0	1.0	2.4	43.8	35.0	3.66	56.8	12.0	6.0	1.0	2.4	64.3	3.97	50.8	4.8
	9.0	2.1	5.0	45.4	35.6	3.42	57.5	13.3	9.0	2.1	4.9	67.2	4.05	53.4	4.9
90	12.0	3.6	8.4	46.1	35.9	3.31	57.9	13.9	12.0	3.6	8.4	68.9	4.10	54.9	4.9
	6.0	1.0	2.3	41.3	33.8	4.11	55.9	10.1	Operation Not Recommended						
	9.0	2.1	4.8	42.9	34.5	3.81	56.5	11.3							
12.0	3.5	8.0	43.7	34.9	3.68	56.8	11.9								
100	6.0	1.0	2.3	38.7	32.4	4.69	55.4	8.3							
	9.0	2.0	4.5	40.3	33.3	4.31	55.7	9.4							
	12.0	3.3	7.6	41.2	33.7	4.14	55.9	9.9							
110	6.0	1.0	2.3	36.1	30.7	5.43	55.4	6.6							
	9.0	1.9	4.3	37.7	31.8	4.95	55.3	7.6							
	12.0	3.1	7.1	38.5	32.2	4.74	55.4	8.1							

- Interpolation is permissible; extrapolation is not.
- All entering air conditions are 80°F (26.6°C) DB and 67°F (19.4°C) WB in cooling, and 70°F (21°C) DB in heating.
- AHRI/ISO certified conditions are 80.6°F (27°C) DB and 66.2°F (19°C) WB in cooling and 68°F (20°C) DB in heating.
- Table does not reflect fan or pump power corrections for AHRI/ISO conditions.
- All performance is based upon the lower voltage of dual voltage rated units.
- Performance stated is at the rated power supply; performance may vary as the power supply varies from the rated.
- Operation below 40°F (4.4°C) is based upon 20% methanol antifreeze solution.
- Operation below 60°F (15.5°C) EWT requires optional insulated water/refrigerant circuit.
- See performance correction tables for operating conditions other than those listed above.
- See Performance Data Selection Notes for operation in the shaded areas.
- For quiet operation and long term reliability, it is recommended that systems be designed to avoid continuous operation in the outlined areas.
- Performance capacities shown in thousands of Btuh

Performance Data SY*060 EC Blower Motor (Part Load)

Models:
SY
024-060

1500 CFM Rated Airflow

EWT °F	GPM	WPD		COOLING - EAT 80/66.2 °F					GPM	WPD		HEATING - EAT 70°F			
		PSI	FT	TC	SC	KW	HR	EER		PSI	FT	HC	kW	HE	COP
20	Operation Not Recommended								10.5	4.9	11.3	25.9	2.59	16.6	2.9
	5.3	1.6	3.6	48.1	34.3	1.57	53.4	30.7	5.3	1.6	3.6	28.9	2.63	19.5	3.2
	7.9	2.9	6.6	48.3	34.2	1.50	53.4	32.2	7.9	2.9	6.6	30.1	2.64	20.7	3.3
30	10.5	4.5	10.3	48.3	34.1	1.48	53.3	32.7	10.5	4.5	10.4	30.7	2.65	21.3	3.4
	5.3	1.4	3.3	47.4	34.2	1.72	53.3	27.6	5.3	1.4	3.3	33.4	2.67	23.9	3.7
	7.9	2.6	6.0	47.9	34.3	1.61	53.4	29.8	7.9	2.7	6.1	34.8	2.68	25.3	3.8
40	10.5	4.2	9.6	48.1	34.3	1.56	53.4	30.8	10.5	4.2	9.7	35.6	2.69	26.0	3.9
	5.3	1.3	3.0	46.4	33.9	1.85	53.0	25.0	5.3	1.3	3.0	37.8	2.70	28.2	4.1
	7.9	2.5	5.8	47.1	34.1	1.71	53.2	27.5	7.9	2.5	5.8	39.5	2.71	29.9	4.3
50	10.5	4.0	9.2	47.4	34.2	1.65	53.3	28.8	10.5	4.0	9.2	40.4	2.72	30.8	4.4
	5.3	1.2	2.8	45.0	33.3	2.11	52.5	21.3	5.3	1.2	2.8	42.2	2.73	32.5	4.5
	7.9	2.4	5.5	45.9	33.7	1.93	52.8	23.8	7.9	2.4	5.5	44.1	2.74	34.4	4.7
60	10.5	3.8	8.7	46.4	33.9	1.85	53.0	25.0	10.5	3.8	8.7	45.2	2.74	35.4	4.8
	5.3	1.2	2.7	43.2	32.6	2.41	51.8	18.0	5.3	1.2	2.7	46.5	2.75	36.8	5.0
	7.9	2.3	5.2	44.4	33.1	2.20	52.2	20.2	7.9	2.3	5.2	48.6	2.76	38.8	5.2
70	10.5	3.6	8.4	45.0	33.3	2.11	52.5	21.3	10.5	3.6	8.4	49.7	2.76	39.9	5.3
	5.3	1.1	2.6	41.2	31.7	2.74	50.9	15.0	5.3	1.1	2.6	50.7	2.76	40.9	5.4
	7.9	2.2	5.0	42.5	32.3	2.52	51.5	16.9	7.9	2.2	5.0	52.8	2.77	43.0	5.6
80	10.5	3.5	8.1	43.2	32.6	2.41	51.8	17.9	10.5	3.5	8.1	54.0	2.77	44.1	5.7
	5.3	1.1	2.5	38.8	30.7	3.11	49.9	12.5	5.3	1.0	2.4	54.6	2.89	44.7	5.5
	7.9	2.1	4.8	40.4	31.4	2.87	50.6	14.1	7.9	2.0	4.7	56.8	2.90	46.9	5.7
90	10.5	3.4	7.9	41.1	31.7	2.75	50.9	14.9	10.5	3.3	7.6	57.9	2.91	48.0	5.8
	5.3	1.1	2.4	36.2	29.6	3.51	48.7	10.3	Operation Not Recommended						
	7.9	2.0	4.7	37.9	30.3	3.26	49.5	11.6							
10.5	3.3	7.6	38.7	30.7	3.13	49.8	12.4								
110	5.3	1.0	2.4	33.4	28.4	3.93	47.3	8.5							
	7.9	2.0	4.5	35.1	29.1	3.67	48.2	9.6							
	10.5	3.2	7.4	36.0	29.5	3.54	48.6	10.2							
120	5.3	1.0	2.2	30.3	26.9	4.36	45.8	6.9							
	7.9	1.9	4.4	32.1	27.8	4.10	46.7	7.8							
	10.5	3.1	7.1	33.1	28.2	3.97	47.2	8.3							

- Interpolation is permissible; extrapolation is not.
- All entering air conditions are 80°F (26.6°C) DB and 67°F (19.4°C) WB in cooling, and 70°F (21°C) DB in heating.
- AHRI/ISO certified conditions are 80.6°F (27°C) DB and 66.2°F (19°C) WB in cooling and 68°F (20°C) DB in heating.
- Table does not reflect fan or pump power corrections for AHRI/ISO conditions.
- All performance is based upon the lower voltage of dual voltage rated units.
- Performance stated is at the rated power supply; performance may vary as the power supply varies from the rated.
- Operation below 40°F (4.4°C) is based upon 20% methanol antifreeze solution.
- Operation below 60°F (15.5°C) EWT requires optional insulated water/refrigerant circuit.
- See performance correction tables for operating conditions other than those listed above.
- See Performance Data Selection Notes for operation in the shaded areas.
- For quiet operation and long term reliability, it is recommended that systems be designed to avoid continuous operation in the outlined areas.
- Performance capacities shown in thousands of Btuh

Performance Data SY*060 EC Blower Motor (Full Load)

Models:
SY
024-060

1900 CFM Rated Airflow

EWT °F	GPM	WPD		COOLING - EAT 80/66.2 °F					GPM	WPD		HEATING - EAT 70°F									
		PSI	FT	TC	SC	KW	HR	EER		PSI	FT	HC	kW	HE	COP						
20	Operation Not Recommended								15.0	9.0	20.7	38.8	3.58	26.1	3.2						
	7.5	2.6	6.1	64.1	44.3	2.76	73.5	23.2	7.5	2.6	6.1	42.3	3.65	29.3	3.4						
	11.3	5.1	11.8	63.4	44.1	2.62	72.3	24.2	11.3	5.1	11.8	43.8	3.69	30.7	3.5						
30	15.0	8.2	19.0	62.9	43.8	2.56	71.6	24.6	15.0	8.2	19.0	44.6	3.70	31.5	3.5						
	7.5	2.4	5.6	64.3	44.4	2.99	74.5	21.5	7.5	2.4	5.6	47.9	3.77	34.5	3.7						
	11.3	4.8	11.0	64.2	44.4	2.83	73.9	22.7	11.3	4.8	11.0	49.8	3.81	36.3	3.8						
40	15.0	7.6	17.6	64.1	44.3	2.76	73.5	23.2	15.0	7.6	17.6	50.8	3.84	37.2	3.9						
	7.5	2.3	5.2	63.6	44.0	3.11	74.7	20.5	7.5	2.3	5.2	53.8	3.90	39.9	4.0						
	11.3	4.4	10.3	64.2	44.3	2.94	74.6	21.8	11.3	4.4	10.3	56.0	3.95	42.0	4.2						
50	15.0	7.2	16.5	64.3	44.4	2.87	74.5	22.4	15.0	7.2	16.5	57.2	3.98	43.1	4.2						
	7.5	2.1	4.9	62.3	43.5	3.39	74.3	18.4	7.5	2.1	4.9	59.8	4.03	45.5	4.3						
	11.3	4.2	9.7	63.3	43.9	3.20	74.6	19.8	11.3	4.2	9.7	62.4	4.09	47.8	4.5						
60	15.0	6.8	15.7	63.6	44.0	3.11	74.7	20.5	15.0	6.8	15.7	63.7	4.12	49.1	4.5						
	7.5	2.0	4.7	60.3	42.6	3.71	73.5	16.3	7.5	2.0	4.7	65.8	4.17	51.0	4.6						
	11.3	4.0	9.2	61.7	43.2	3.49	74.1	17.7	11.3	4.0	9.2	68.7	4.24	53.6	4.7						
70	15.0	6.5	15.0	62.3	43.4	3.39	74.3	18.4	15.0	6.5	15.0	70.2	4.28	55.0	4.8						
	7.5	2.0	4.5	57.8	41.6	4.08	72.4	14.2	7.5	2.0	4.5	71.8	4.32	56.5	4.9						
	11.3	3.8	8.8	59.5	42.3	3.83	73.1	15.5	11.3	3.8	8.8	74.9	4.40	59.3	5.0						
80	15.0	6.3	14.5	60.3	42.6	3.72	73.5	16.2	15.0	6.3	14.4	76.5	4.44	60.8	5.1						
	7.5	1.9	4.3	55.0	40.4	4.51	71.0	12.2	7.5	1.9	4.3	77.6	4.66	61.7	4.9						
	11.3	3.7	8.5	56.9	41.2	4.23	71.9	13.4	11.3	3.7	8.5	80.9	4.75	64.7	5.0						
90	15.0	6.1	14.0	57.8	41.6	4.10	72.3	14.1	15.0	6.1	14.0	82.6	4.80	66.2	5.0						
	7.5	1.8	4.2	51.8	39.1	5.01	69.6	10.3	Operation Not Recommended												
	11.3	3.6	8.2	53.8	39.9	4.69	70.5	11.5													
15.0	5.9	13.5	54.8	40.3	4.54	71.0	12.1														
100	7.5	1.7	4.0	48.4	37.6	5.59	68.3	8.7													
	11.3	3.4	7.9	50.5	38.5	5.22	69.1	9.7													
	15.0	5.6	13.0	51.6	39.0	5.05	69.5	10.2													
110	7.5	1.6	3.8	44.9	35.9	6.25	67.1	7.2													
	11.3	3.3	7.5	47.0	36.9	5.84	67.8	8.1													
	15.0	5.4	12.5	48.1	37.4	5.64	68.2	8.5													
120																					

- Interpolation is permissible; extrapolation is not.
- All entering air conditions are 80°F (26.6°C) DB and 67°F (19.4°C) WB in cooling, and 70°F (21°C) DB in heating.
- AHRI/ISO certified conditions are 80.6°F (27°C) DB and 66.2°F (19°C) WB in cooling and 68°F (20°C) DB in heating.
- Table does not reflect fan or pump power corrections for AHRI/ISO conditions.
- All performance is based upon the lower voltage of dual voltage rated units.
- Performance stated is at the rated power supply; performance may vary as the power supply varies from the rated.
- Operation below 40°F (4.4°C) is based upon 20% methanol antifreeze solution.
- Operation below 60°F (15.5°C) EWT requires optional insulated water/refrigerant circuit.
- See performance correction tables for operating conditions other than those listed above.
- See Performance Data Selection Tables for operation in the shaded areas.
- For quiet operation and long term reliability, it is recommended that systems be designed to avoid continuous operation in the outlined areas.
- Performance capacities shown in thousands of Btuh

Blower Performance: CV EC Standard Unit

Models:
SY
024-060

CV EC MOTOR ADVANTAGE

A major benefit of the CV EC motor over other blower motor types is its ability to adjust airflow remotely through the iGate 2 web portal/mobile app or directly at the unit with a communicating diagnostic service tool. Airflow levels can be adjusted in increments of 25 CFM from the unit's minimum and maximum CFM range (see the Blower Performance: CV EC Blower Motor Standard Unit table for details).

Blower Performance: CV EC Blower Motor Standard Unit

Model	Max ESP (in wg)	Fan Motor (hp)	Range	Cooling Mode		Heating Mode		Dehumid Mode		Fan Only Mode	Aux Emergency Mode
				Stg 2	Stg 1	Stg 2	Stg 1	Stg 2	Stg 1		
SY024	0.75	1/2	Minimum	600	450	600	450	600	450	300	600
			Default	750	600	750	600	650	500	350	750
			Maximum	850	650	850	650	800	600	850	850
SY030	0.5	1/2	Minimum	750	550	750	550	750	550	375	750
			Default	925	750	925	750	800	625	425	925
			Maximum	1050	800	1050	800	1000	750	1050	1050
SY036	0.6	3/4	Minimum	900	675	900	675	900	675	450	900
			Default	1125	900	1125	900	975	750	525	1125
			Maximum	1275	975	1275	975	1200	900	1275	1275
SY042	0.6	3/4	Minimum	1050	775	1050	775	1050	775	525	1050
			Default	1300	1050	1300	1050	1125	875	600	1300
			Maximum	1475	1125	1475	1125	1400	1050	1475	1475
SY048	0.6	3/4	Minimum	1200	900	1200	900	1200	900	600	1200
			Default	1500	1200	1500	1200	1300	1000	700	1500
			Maximum	1700	1300	1700	1300	1600	1200	1700	1700
SY060	0.75	1	Minimum	1500	1125	1500	1125	1500	1125	750	1500
			Default	1875	1500	1875	1500	1625	1250	875	1875
			Maximum	2125	1625	2125	1625	2000	1500	2125	2125

- Blower performance data is based on the lowest nameplate voltage setting.
- Blower performance is based on a wet coil with clean 1-inch filter.
- Blower performance is based on operating conditions of 80°F DB and 67°F WB.
- CFM Tolerance is ±7%

Part Load Performance: Correction Tables

Models:
SY
024-060

Cooling Correction

Entering Air WB °F	Total Capacity	Sensible Cooling Capacity Multipliers - Entering DB °F						Power	Heat of Rejection
		65	70	75	80	85	90		
45	0.623	*	*	*	*	*	*	1.020	0.720
50	0.708	*	*	*	*	*	*	1.015	0.783
55	0.794	*	*	*	*	*	*	1.011	0.847
60	0.880	0.671	0.883	*	*	*	*	1.006	0.911
65	0.966		0.662	0.868	1.088	1.279	*	1.002	0.975
67	1.000		0.574	0.779	1.000	1.190	1.396	1.000	1.000
70	1.051			0.646	0.868	1.057	1.263	0.997	1.038
75	1.137				0.648	0.835	1.041	0.993	1.102

Notes:

- AHRI/ISO/ASHRAE 13256-1 uses entering air conditions of Cooling - 80.6°F (27°C) DB/ 66.2°F (19°C) WB, and Heating 68°F (20°C) DB/ 59°F (15°C) WB entering air temperature.
- Asterisks indicate that no correction factor is needed, Total Capacity equals Sensible capacity.
- Entering DB temperature range is based on operating limits, not on commission limits.
- Cooling and heating air corrections based on rated airflow.

Entering Air Heating Correction

Entering Air WB °F	Heating Capacity	Power	Heat of Rejection
50	1.020	0.763	1.102
55	1.015	0.822	1.076
60	1.010	0.882	1.051
65	1.005	0.941	1.025
70	1.000	1.000	1.000
75	0.995	1.059	0.975
80	0.990	1.118	0.949

Airflow Correction

% of Rated	Heating			Cooling				
	Heating Capacity	Power	Heat of Extraction	Total Capacity	Sensible Capacity	S/T	Power	Heat of Rejection
80	0.969	1.009	0.974	0.979	0.905	0.924	0.947	0.979
85	0.977	1.007	0.980	0.984	0.929	0.944	0.961	0.984
90	0.984	1.005	0.987	0.989	0.952	0.963	0.974	0.989
95	0.992	1.002	0.993	0.995	0.976	0.981	0.987	0.995
100	1.000	1.000	1.000	1.000	1.000	1.000	1.000	1.000
105	1.008	0.998	1.007	1.005	1.024	1.018	1.013	1.005
110	1.016	0.995	1.013	1.011	1.048	1.037	1.026	1.011

ClimateMaster works continually to improve its products. As a result, the design and specifications of each product at the time of order may be changed without notice and may not be as described herein. Please contact ClimateMaster's Customer Service Department at 800-299-9747 for specific information on the current design and specifications. Statements and other information contained herein are not express warranties and do not form the basis of any bargain between the parties, but are merely ClimateMaster's opinion or commendation of its products. The latest version of this document is available at www.climatemaster.com. Engineered and assembled in the USA. © ClimateMaster, Inc. All Rights Reserved 2024

Full Load Performance: Correction Tables

Cooling Correction

Entering Air WB °F	Total Capacity	Sensible Cooling Capacity Multipliers - Entering DB °F						Power	Heat of Rejection
		65	70	75	80	85	90		
45	0.651	*	*	*	*	*	*	0.927	0.723
50	0.730	*	*	*	*	*	*	0.944	0.786
55	0.809	*	*	*	*	*	*	0.960	0.849
60	0.889	0.689	0.894	*	*	*	*	0.977	0.912
65	0.968		0.672	0.877	1.087	1.287	*	0.993	0.975
67	1.000		0.583	0.788	1.000	1.199	1.404	1.000	1.000
70	1.048			0.655	0.869	1.067	1.272	1.010	1.038
75	1.127				0.650	0.847	1.053	1.027	1.101

Notes:

- AHRI/ISO/ASHRAE 13256-1 uses entering air conditions of Cooling - 80.6°F (27°C) DB/ 66.2°F (19°C) WB, and Heating 68°F (20°C) DB/ 59°F (15°C) WB entering air temperature.
- Asterisks indicate that no correction factor is needed, Total Capacity equals Sensible capacity.
- Entering DB temperature range is based on operating limits, not on commission limits.
- Cooling and heating air corrections based on rated airflow.

Entering Air Heating Correction

Entering Air WB °F	Heating Capacity	Power	Heat of Rejection
50	1.026	0.807	1.103
55	1.019	0.855	1.077
60	1.013	0.904	1.052
65	1.006	0.952	1.026
70	1.000	1.000	1.000
75	0.994	1.048	0.974
80	0.987	1.096	0.948

Airflow Correction

% of Rated	Heating			Cooling				
	Heating Capacity	Power	Heat of Extraction	Total Capacity	Sensible Capacity	S/T	Power	Heat of Rejection
80	0.963	1.008	0.965	0.975	0.913	0.936	0.937	0.974
85	0.972	1.006	0.974	0.981	0.935	0.952	0.952	0.980
90	0.981	1.004	0.983	0.988	0.956	0.968	0.968	0.987
95	0.991	1.002	0.991	0.994	0.978	0.984	0.984	0.993
100	1.000	1.000	1.000	1.000	1.000	1.000	1.000	1.000
105	1.009	0.998	1.009	1.006	1.022	1.015	1.016	1.007
110	1.019	0.996	1.017	1.012	1.044	1.031	1.032	1.013

ClimateMaster works continually to improve its products. As a result, the design and specifications of each product at the time of order may be changed without notice and may not be as described herein. Please contact ClimateMaster's Customer Service Department at 800-299-9747 for specific information on the current design and specifications. Statements and other information contained herein are not express warranties and do not form the basis of any bargain between the parties, but are merely ClimateMaster's opinion or commendation of its products. The latest version of this document is available at www.climatemaster.com. Engineered and assembled in the USA. © ClimateMaster, Inc. All Rights Reserved 2024

Antifreeze Correction Table

Models:
SY
024-060

EWT (°F)	Antifreeze Type	Antifreeze %	Cooling			Heating		WPD
			Total Cap	Sensible Cap	Watts	Total Cap	Watts	
90	Water	0%	1.000	1.000	1.000	1.000	1.000	1.000
	Ethanol	5%	0.998	0.998	1.002	0.996	0.999	1.025
		10%	0.996	0.996	1.003	0.991	0.997	1.048
		15%	0.994	0.994	1.005	0.987	0.996	1.098
		20%	0.991	0.991	1.006	0.982	0.994	1.142
		25%	0.986	0.986	1.009	0.972	0.991	1.207
		30%	0.981	0.981	1.012	0.962	0.988	1.265
		35%	0.977	0.977	1.015	0.953	0.985	1.312
		40%	0.972	0.972	1.018	0.943	0.982	1.370
		45%	0.966	0.966	1.023	0.931	0.978	1.431
		50%	0.959	0.959	1.027	0.918	0.974	1.494
	Ethylene Glycol	5%	0.998	0.998	1.002	0.996	0.999	1.021
		10%	0.996	0.996	1.003	0.991	0.997	1.040
		15%	0.994	0.994	1.004	0.987	0.996	1.079
		20%	0.991	0.991	1.005	0.982	0.995	1.114
		25%	0.988	0.988	1.008	0.976	0.993	1.146
		30%	0.985	0.985	1.010	0.969	0.990	1.175
		35%	0.982	0.982	1.012	0.963	0.988	1.208
		40%	0.979	0.979	1.014	0.956	0.986	1.243
		45%	0.976	0.976	1.016	0.950	0.984	1.278
		50%	0.972	0.972	1.018	0.943	0.982	1.314
	Methanol	5%	0.997	0.997	1.002	0.993	0.998	1.039
		10%	0.993	0.993	1.004	0.986	0.996	1.075
		15%	0.990	0.990	1.007	0.979	0.994	1.116
		20%	0.986	0.986	1.009	0.972	0.991	1.154
		25%	0.982	0.982	1.012	0.964	0.989	1.189
		30%	0.978	0.978	1.014	0.955	0.986	1.221
		35%	0.974	0.974	1.017	0.947	0.984	1.267
		40%	0.970	0.970	1.020	0.939	0.981	1.310
		45%	0.966	0.966	1.023	0.930	0.978	1.353
		50%	0.961	0.961	1.026	0.920	0.975	1.398
	Propylene Glycol	5%	0.995	0.995	1.003	0.990	0.997	1.065
		10%	0.990	0.990	1.006	0.980	0.994	1.119
		15%	0.986	0.986	1.009	0.971	0.991	1.152
		20%	0.981	0.981	1.012	0.962	0.988	1.182
		25%	0.978	0.978	1.014	0.956	0.986	1.227
		30%	0.975	0.975	1.016	0.950	0.984	1.267
		35%	0.972	0.972	1.018	0.944	0.982	1.312
		40%	0.969	0.969	1.020	0.938	0.980	1.356
		45%	0.965	0.965	1.023	0.929	0.977	1.402
		50%	0.960	0.960	1.026	0.919	0.974	1.450

Table continued on next page

ClimateMaster works continually to improve its products. As a result, the design and specifications of each product at the time of order may be changed without notice and may not be as described herein. Please contact ClimateMaster's Customer Service Department at 800-299-9747 for specific information on the current design and specifications. Statements and other information contained herein are not express warranties and do not form the basis of any bargain between the parties, but are merely ClimateMaster's opinion or commendation of its products. The latest version of this document is available at www.climatemaster.com. Engineered and assembled in the USA. © ClimateMaster, Inc. All Rights Reserved 2024

Antifreeze Correction Table

Models:
SY
024-060

Table continued from previous page

EWT (°F)	Antifreeze Type	Antifreeze %	Cooling			Heating		WPD
			Total Cap	Sensible Cap	Watts	Total Cap	Watts	
30	Water	0%	1.000	1.000	1.000	1.000	1.000	1.000
	Ethanol	5%	0.991	0.991	1.006	0.981	0.994	1.140
		10%	0.981	0.981	1.012	0.961	0.988	1.242
		15%	0.973	0.973	1.018	0.944	0.983	1.295
		20%	0.964	0.964	1.024	0.927	0.977	1.343
		25%	0.959	0.959	1.028	0.917	0.974	1.363
		30%	0.954	0.954	1.031	0.907	0.970	1.383
		35%	0.949	0.949	1.035	0.897	0.967	1.468
		40%	0.944	0.944	1.038	0.887	0.964	1.523
		45%	0.940	0.940	1.041	0.880	0.962	1.580
	50%	0.936	0.936	1.043	0.872	0.959	1.639	
	Ethylene Glycol	5%	0.997	0.997	1.002	0.993	0.998	1.040
		10%	0.993	0.993	1.004	0.986	0.996	1.075
		15%	0.990	0.990	1.006	0.980	0.994	1.122
		20%	0.987	0.987	1.008	0.973	0.992	1.163
		25%	0.983	0.983	1.011	0.966	0.990	1.195
		30%	0.979	0.979	1.013	0.958	0.987	1.225
		35%	0.976	0.976	1.016	0.951	0.985	1.279
		40%	0.972	0.972	1.018	0.943	0.982	1.324
		45%	0.969	0.969	1.021	0.937	0.980	1.371
	50%	0.966	0.966	1.023	0.930	0.978	1.419	
	Methanol	5%	0.995	0.995	1.004	0.989	0.997	1.069
		10%	0.989	0.989	1.007	0.978	0.993	1.127
		15%	0.984	0.984	1.011	0.968	0.990	1.164
		20%	0.979	0.979	1.014	0.957	0.986	1.197
		25%	0.975	0.975	1.017	0.949	0.984	1.216
		30%	0.971	0.971	1.019	0.941	0.981	1.235
		35%	0.967	0.967	1.022	0.933	0.979	1.286
		40%	0.963	0.963	1.025	0.924	0.976	1.323
		45%	0.959	0.959	1.028	0.917	0.974	1.360
	50%	0.955	0.955	1.030	0.910	0.971	1.399	
	Propylene Glycol	5%	0.995	0.995	1.004	0.989	0.997	1.071
		10%	0.989	0.989	1.007	0.978	0.993	1.130
		15%	0.985	0.985	1.010	0.968	0.990	1.206
		20%	0.980	0.980	1.013	0.958	0.987	1.270
		25%	0.974	0.974	1.017	0.947	0.983	1.359
		30%	0.968	0.968	1.021	0.935	0.979	1.433
		35%	0.963	0.963	1.025	0.924	0.976	1.522
		40%	0.957	0.957	1.029	0.913	0.972	1.614
		45%	0.949	0.949	1.034	0.898	0.967	1.712
	50%	0.941	0.941	1.039	0.882	0.962	1.816	

ClimateMaster works continually to improve its products. As a result, the design and specifications of each product at the time of order may be changed without notice and may not be as described herein. Please contact ClimateMaster's Customer Service Department at 800-299-9747 for specific information on the current design and specifications. Statements and other information contained herein are not express warranties and do not form the basis of any bargain between the parties, but are merely ClimateMaster's opinion or commendation of its products. The latest version of this document is available at www.climatemaster.com. Engineered and assembled in the USA. © ClimateMaster, Inc. All Rights Reserved 2024

Tranquility (SY) Series

Unit Size	024	030	036	042	048	060
Compressor (1 Each)	Scroll					
Number of refrigerant circuits	1	1	1	1	1	1
Factory Charge R-454B (oz)	40	36	46	56	56	69
Refrigerant Leak Detection System	O	O	O	O	O	R
Number of Sensors	2	2	2	2	2	2
Water Connection Size						
FPT - All Other (inch)	3/4"	3/4"	3/4"	3/4"	1"	1"
System Water Volume (gal)*	0.323	0.323	0.738	0.89	0.89	0.939
Vertical Upflow						
Filter Standard - 1" Throwaway (inch)	20x20	20x20	24x24	24x24	28x28	28x28
Weight - Operating (lbs.)	216	224	245	260	315	330
Weight - Packaged (lbs.)	221	229	251	266	322	337
Horizontal						
Filter Standard - 1" Throwaway	18x24	18x24	2-14x20	2-14x20	1-20x24 1-14x20	1-20x24 1-14x20
Weight - Operating (lbs.)	208	208	233	244	299	314
Weight - Packaged (lbs.)	213	213	239	250	306	321

Notes:

All dimensions displayed above are in inches unless otherwise marked.
 The standard Condensate Drain Connection is rubber coupling that couples to 3/4-inch schedule 40/80 PVC.
 The optional Stainless Steel Condensate Drain Connection is 3/4-inch FPT.
 FPT = Female Pipe Thread.
 O = Optional, R = Required

Unit Maximum Water Working Pressure

Unit Maximum Water Working Pressure	
Options	Max Pressure PSIG [kPa]
Base Unit	300 [2068]

Dimensional Data

Models:
SY
024-060

Cabinet Dimensions (inch)

Model	Cabinet Config	Depth/Length	Width	Height
		A	B	C
SY024-030	H	43.0	20.1	18.3
	V	21.5	21.6	40.0
SY036-042	H	47.1	20.1	21.0
	V	26.0	21.6	45.0
SY048-060	H	54.1	24.1	21.0
	V	29.3	25.5	50.5

Electrical Knockouts (inch)

Model	Cabinet Config	H	Low Voltage	High Voltage	G
			J KO 1/2"	K KO 3/4"	
SY024-030	H	4.1	7.1	14.1	1.3
	V	4.1	7.1	15.1	19.7
SY036-042	H	4.1	7.1	17.1	1.3
	V	4.1	7.1	15.8	1.3
SY048-060	H	4.1	7.1	17.1	1.3
	V	4.1	7.1	16.7	1.3

Water Connections (inch)

Model	Cabinet Config	Water Connections					Condensate Drain Pan			
		Water In		Water Out		Water In/Out	AA	BB	Condensate Drain Pan Fitting	
		D	E	F	E					
SY024-30	H	2.0	1.5	15.4	1.5	3/4"	3.5	0.8	*3/4" MPT	
	V	3.7	1.5	9.8	1.5	3/4"	19.7	1.4	*3/4" MPT	
SY036-042	H	2.0	1.6	16.8	1.6	3/4"	3.4	0.8	*3/4" MPT	
	V	3.7	1.5	9.8	1.5	3/4"	20.7	1.4	*3/4" MPT	
SY048-060	H	2.0	1.5	17.4	1.5	1"	3.4	0.8	*3/4" MPT	
	V	3.7	2.0	11.1	2.0	1"	22.1	1.4	*3/4" MPT	

* See PDF drawings for reference

Discharge and Return Connections (inch)

Model	Cabinet Config	Discharge Connection Duct Flange Installed				Return Connection Using Return Air Opening				
		Supply Height	Supply Width	O	P	Return Width	Return Height	S	T	
		M	N			Q	R			
SY024-030	H	9.6	13.1	3.9	1.2	22.9	16.3	1.1	1.0	
	V	14.0	14.0	6.6	3.7	18.4	18.3	2.3	1.0	
SY036-042	H	10.9	16.1	3.0	2.5	25.9	19.0	1.1	1.0	
	V	14.0	14.0	6.6	6.0	22.9	22.2	2.3	1.0	
SY048-060	H	13.5	15.9	4.1	1.2	35.9	19.0	1.1	1.0	
	V	18.0	16.0	8.5	5.6	26.2	26.3	2.4	1.0	

Hanger Dimensions (inch)

Model	Cabinet Config	Unit Hanger Detail		
		U	V	W
SY024-030	H	43.0	22.1	17.9
SY036-042	H	47.0	22.6	17.9
SY048-060	H	54.0	26.2	21.9

ClimateMaster works continually to improve its products. As a result, the design and specifications of each product at the time of order may be changed without notice and may not be as described herein. Please contact ClimateMaster's Customer Service Department at 800-299-9747 for specific information on the current design and specifications. Statements and other information contained herein are not express warranties and do not form the basis of any bargain between the parties, but are merely ClimateMaster's opinion or commendation of its products. The latest version of this document is available at www.climatemaster.com. Engineered and assembled in the USA. © ClimateMaster, Inc. All Rights Reserved 2024

Dimensional Data

Models:
SY
024-060

Cabinet Dimensions (cm)

Model	Cabinet Config	Depth/Length	Width	Height
		A	B	C
SY024-030	H	109.3	51.2	46.4
	V	54.7	54.9	101.7
SY036-042	H	119.5	51.1	53.3
	V	66.2	54.8	114.3
SY048-060	H	137.3	61.2	53.3
	V	74.5	64.7	128.3

Electrical Knockouts (cm)

Model	Cabinet Config	H	Low Voltage	High Voltage	G
			J KO 1/2"	K KO 3/4"	
SY024-030	H	10.5	18.1	35.9	3.2
	V	10.5	18.1	38.4	50.1
SY036-042	H	10.5	18.1	43.5	3.2
	V	10.5	18.1	40.1	3.2
SY048-060	H	10.5	18.1	43.5	3.2
	V	10.5	18.1	42.4	3.2

Water Connections (cm)

Model	Cabinet Config	Water Connections					Condensate Drain Pan			
		Water In		Water Out		Water In/Out	AA	BB	Condensate Drain Pan Fitting	
		D	E	F	E					
SY024-030	H	5.1	3.8	39.1	3.8	3/4"	8.8	2.0	*3/4" MPT	
	V	9.5	3.9	24.8	3.9	3/4"	50.1	3.7	*3/4" MPT	
SY036-042	H	5.1	4.0	42.5	4.0	3/4"	8.7	2.1	*3/4" MPT	
	V	9.5	3.8	24.8	3.8	3/4"	52.5	3.7	*3/4" MPT	
SY048-060	H	5.1	3.8	44.1	3.8	1"	8.7	2.1	*3/4" MPT	
	V	9.5	5.1	28.1	5.1	1"	56.2	3.7	*3/4" MPT	

Discharge and Return Connections (cm)

Model	Cabinet Config	Discharge Connection Duct Flange Installed				Return Connection Using Return Air Opening				
		Supply Height	Supply Width	O	P	Return Width	Return Height	S	T	
		M	N			Q	R			
SY024-030	H	24.5	33.3	10.0	3.0	58.3	41.3	2.8	2.5	
	V	35.6	35.5	16.8	9.5	46.8	46.4	5.9	2.5	
SY036-042	H	27.8	40.9	7.5	6.2	65.9	48.3	2.8	2.5	
	V	35.6	35.5	16.8	15.3	58.2	56.4	5.9	2.5	
SY048-060	H	34.3	40.4	10.3	3.0	91.3	48.3	2.8	2.5	
	V	45.7	40.6	21.5	14.3	66.5	66.8	6.0	2.5	

Hanger Dimensions (cm)

Model	Cabinet Config	U	V	W
SY024-030	H	109.3	56.2	45.6
SY036-042	H	119.5	57.5	45.6
SY048-060	H	137.2	66.5	55.7

ClimateMaster works continually to improve its products. As a result, the design and specifications of each product at the time of order may be changed without notice and may not be as described herein. Please contact ClimateMaster's Customer Service Department at 800-299-9747 for specific information on the current design and specifications. Statements and other information contained herein are not express warranties and do not form the basis of any bargain between the parties, but are merely ClimateMaster's opinion or commendation of its products. The latest version of this document is available at www.climatemaster.com. Engineered and assembled in the USA. © ClimateMaster, Inc. All Rights Reserved 2024

Corner Weights (lb)

Model	Left - Front	Right - Front	Left - Back	Right/Back
SY024	62	40	39	33
SY030	67	41	40	34
SY036	75	47	44	37
SY042	81	50	48	39
SY048	98	60	58	47
SY060	103	64	61	75

Corner Weights (kg)

Model	Left - Front	Right - Front	Left - Back	Right/Back
SY024	28.1	18.1	17.7	15.0
SY030	30.4	18.6	18.1	15.4
SY036	34.0	21.3	20.0	16.8
SY042	36.7	22.7	21.8	17.7
SY048	44.5	27.2	26.3	21.3
SY060	46.7	29.0	27.7	34.0

Horizontal Dimensional Data

Models:
SY
024-060

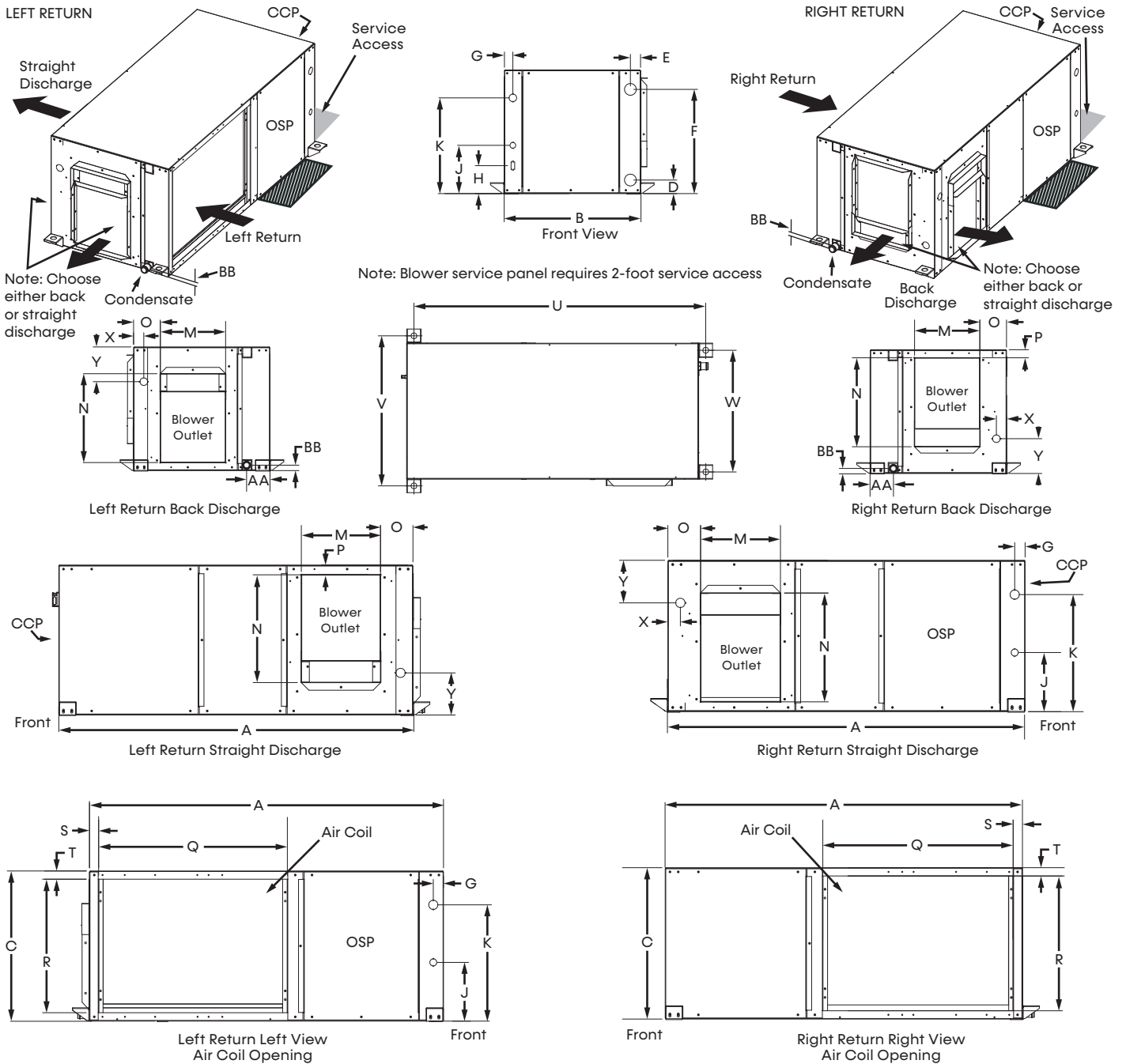

Notes:

1. While clear access to all removable panels is not required, installer should take care to comply with all building codes and allow adequate clearance for future field service.
2. Units come standard with air filter rails. For duct connections, order optional filter frames. See product options decoder for details. You can convert filter rails in the field with an accessory air filter frame kit. Please see the accessory submittal for details.
3. Discharge flange and hanger brackets are factory installed.
4. Condensate is a rubber coupling that couples to 3/4-inch schedule 40/80 PVC.
5. Blower service panel requires 2-foot service access.
6. Blower service access is through back panel on straight discharge units or through panel opposite air coil on back discharge units.
7. OSP are removable panels that provide additional access to the units interior. Clear access to OSP panels is not required and they are not to be used in place of the mandatory CCP and BSP panels.

Legend:

- CCP = Control/Compressor Access
- BSP = Blower Service Panel
- OSP = Optional Service Panel (not required)

ClimateMaster works continually to improve its products. As a result, the design and specifications of each product at the time of order may be changed without notice and may not be as described herein. Please contact ClimateMaster's Customer Service Department at 800-299-9747 for specific information on the current design and specifications. Statements and other information contained herein are not express warranties and do not form the basis of any bargain between the parties, but are merely ClimateMaster's opinion or commendation of its products. The latest version of this document is available at www.climatemaster.com. Engineered and assembled in the USA. © ClimateMaster, Inc. All Rights Reserved 2024

Horizontal Service Access

Models:
SY
024-060

Left Return Back Discharge

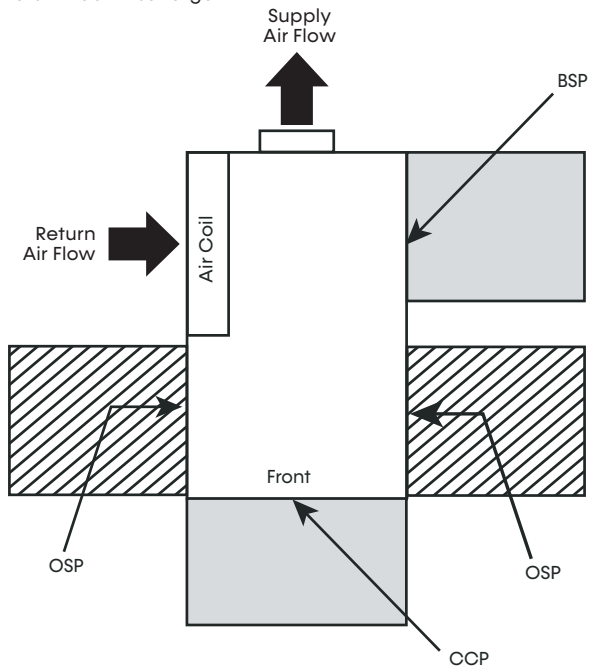

Right Return Back Discharge

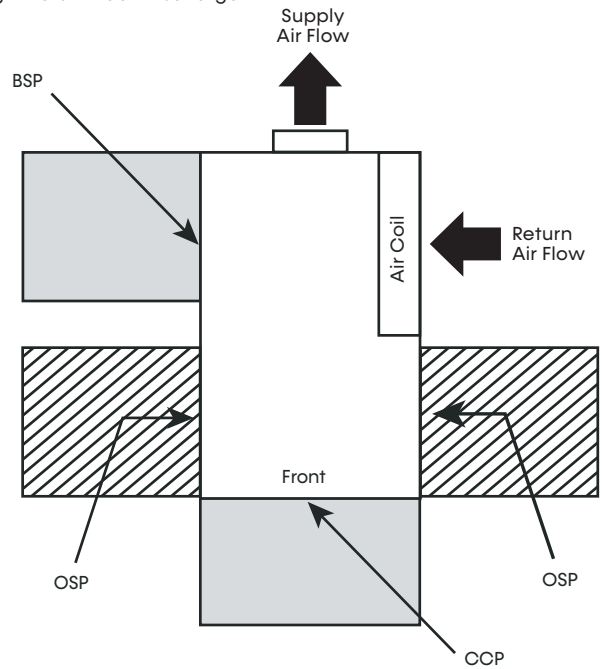

Left Return Straight Discharge

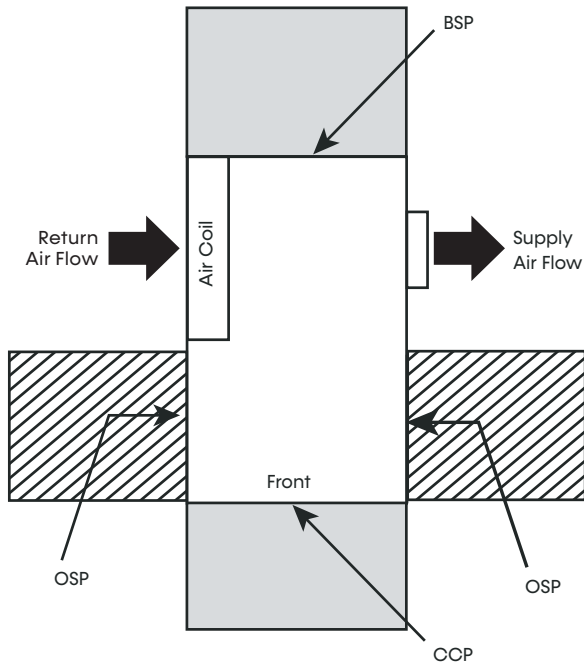

Right Return Straight Discharge

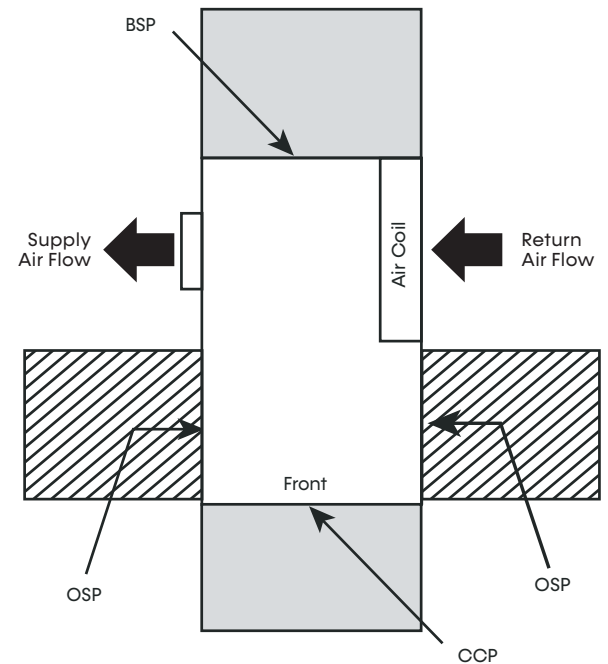

Notes:

1. While clear access to all removable panels is not required, installer should take care to comply with all building codes and allow adequate clearance for future field service.
2. CCP and BSP requires 2-feet of service access.
3. Blower service access is through back panel on straight discharge units or through panel opposite air coil on back discharge units.
4. OSP are removable panels that provide additional access to the units interior. Clear access to OSP panels is not required and they are not to be used in place of the mandatory CCP and BSP panels.

 = Mandatory Service Access 2-foot (61 cm)

 = Optional Service Access 2-foot (61 cm)

Legend:

CCP = Control/Compressor Access

BSP = Blower Service Panel

OSP = Optional Service Panel (not required)

ClimateMaster works continually to improve its products. As a result, the design and specifications of each product at the time of order may be changed without notice and may not be as described herein. Please contact ClimateMaster's Customer Service Department at 800-299-9747 for specific information on the current design and specifications. Statements and other information contained herein are not express warranties and do not form the basis of any bargain between the parties, but are merely ClimateMaster's opinion or commendation of its products. The latest version of this document is available at www.climatemaster.com. Engineered and assembled in the USA. © ClimateMaster, Inc. All Rights Reserved 2024

Vertical Upflow Dimensional Data

Models:
SY
024-060

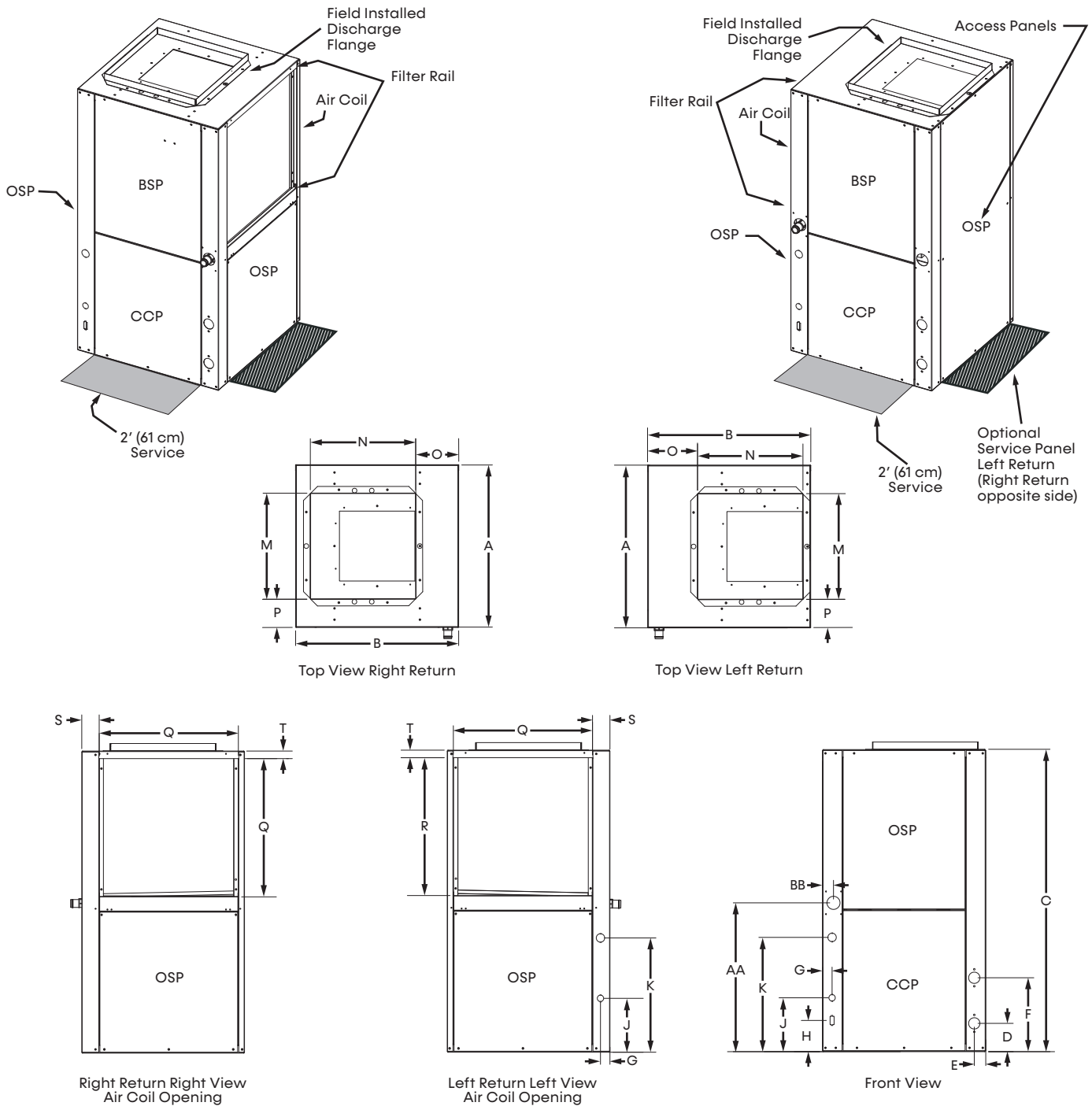

Notes:

1. While clear access to all removable panels is not required, installer should take care to comply with all building codes and allow adequate clearance for future field service. Front and side access is preferred for service access. However, all components may be serviced from the front access panel if side access is not available. (Except on vertical sizes 024-030).
2. Discharge flange is field installed.
3. Condensate fitting on polymer drain pan is rubber coupling that couples to 3/4-inch schedule 40/80 PVC, S.S. drain pan is 3/4-inch MPT.
4. Units are shipped with air filter rails that are not suitable for supporting return air ductwork. An air filter frame with duct mounting collar is available as an accessory, see the Accessory Submittal set for further information on this frame.

Legend:

- CCP = Control/Compressor Access
- BSP = Blower Service Panel
- OSP = Optional Service Panel (not required)

ClimateMaster works continually to improve its products. As a result, the design and specifications of each product at the time of order may be changed without notice and may not be as described herein. Please contact ClimateMaster's Customer Service Department at 800-299-9747 for specific information on the current design and specifications. Statements and other information contained herein are not express warranties and do not form the basis of any bargain between the parties, but are merely ClimateMaster's opinion or commendation of its products. The latest version of this document is available at www.climatemaster.com. Engineered and assembled in the USA. © ClimateMaster, Inc. All Rights Reserved 2024

Vertical Service Access

Models:
SY
024-060

Left Return

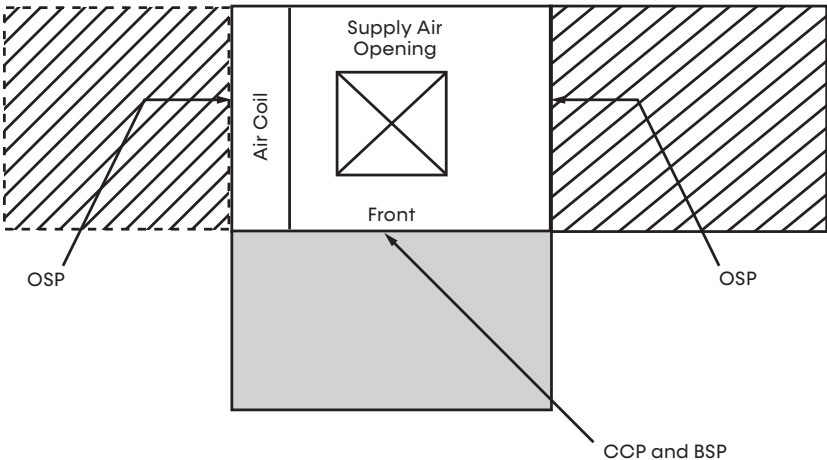

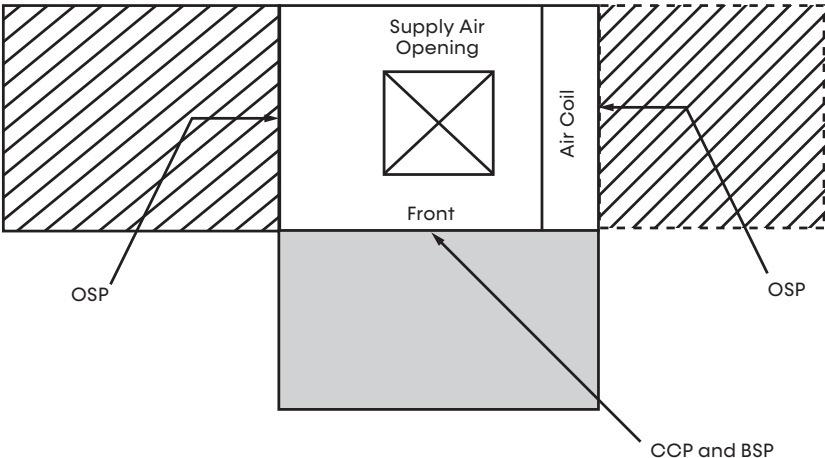

Right Return



Notes:

1. While clear access to all removable panels is not required, installer should take care to comply with all building codes and allow adequate clearance for future field service.
2. Front and side access is preferred for service access. However, all components may be serviced from the front access panel if side access is not available.
3. OSP are removable panels that provide additional access to the units interior. Clear access to OSP panels is not required and they are not to be used in place of the mandatory CCP and BSP panels.
4. Top supply air is shown, the same clearances apply to bottom supply air units.

-  = Mandatory Service Access 2-foot (61 cm)
-  = Optional Service Access 2-foot (61 cm)

- Legend:
- CCP = Control/Compressor Access
 - BSP = Blower Service Panel
 - OSP = Optional Service Panel (not required)

ClimateMaster works continually to improve its products. As a result, the design and specifications of each product at the time of order may be changed without notice and may not be as described herein. Please contact ClimateMaster's Customer Service Department at 800-299-9747 for specific information on the current design and specifications. Statements and other information contained herein are not express warranties and do not form the basis of any bargain between the parties, but are merely ClimateMaster's opinion or commendation of its products. The latest version of this document is available at www.climatemaster.com. Engineered and assembled in the USA. © ClimateMaster, Inc. All Rights Reserved 2024

MINIMUM INSTALLATION AREA

Minimum area where a blower-equipped unit must be installed, and mechanical/natural ventilation is not required

Model	Charge (oz)	Configuration	Minimum Installation Area ft ² (m ²) [A _{min}]			
			Floor	Window	Wall	Ceiling
SY060	69	Vertical	237 (22.0)	132 (12.2)	76 (7.0)	63 (5.9)
		Horizontal	237 (22.0)	141 (13.1)	79 (7.3)	65 (3.0)

A _{min}	=	Minimum area where unit is installed where unit has incorporated airflow
h _{inst} (floor)	=	0.0 ft (0.0 m)
h _{inst} (window)	=	3.3 ft (1.0 m)
h _{inst} (wall)	=	5.9 ft (1.8 m)
h _{inst} (ceiling)	=	7.2 ft (2.2 m)

Minimum area and CFM requirements for the conditioned space

Model	Charge (oz)	Minimum CFM [Q _{min}]	
		TA _{min} (ft ²)	Q _{min} (ft ³ /min)
SY060	69	3.54	117

TA _{min}	=	Minimum conditioned area for venting leaked refrigerant
Q _{min}	=	Minimum ventilation flow rate for conditioned space if space is less than TA _{min}

Minimum area of opening for natural ventilation

Model	Charge (oz)	A _{nv} (in ²)
SY060	69	111.57

A_{nv} = Minimum natural ventilation area opening

When the openings for connected rooms or natural ventilation are required, the following conditions shall be applied:

- The area of any openings above 11.8 inches (300 mm) from the floor shall not be considered in determining compliance with Anv_{min}.
- At least 50% of the required opening area Anv_{min} shall be below 7.8 inches (200 mm) from the floor.
- The bottom of the lowest openings shall not be higher than the point of release when the unit is installed and not more than 3.9 inches (100 mm) from the floor.
- Openings are permanent openings which cannot be closed.
- For openings extending to the floor, the height shall not be less than 0.78 inch (20 mm) above the surface of the floor covering.
- A second higher opening shall be provided. The total size of the second opening shall not be less than 50% of minimum opening area for Anv_{min} and shall be at least 3.3 ft (1.5 m) above the floor.

Electrical Data: CV EC Blower Motor Standard Unit

Models:
SY
024-060

Model	Voltage Code	Voltage	Min/Max Voltage	Compressor			Fan Motor FLA	Total Unit FLA	Min Circ Amp	Max Fuse/HACR
				RLA	LRA	Qty				
SY024	G.J.	208/230-60-1	197/252	10.3	62.0	1	4.2	14.5	17.1	25
	H.K.	208/230-60-3	197/252	6.3	56.0	1	4.2	10.5	12.1	15
	F.L.	460-60-3*	414/506	3.8	29.0	1	3.4	7.2	8.2	15
SY030	G.J.	208/230-60-1	197/252	14.6	82.0	1	4.2	18.8	22.5	35
	H.K.	208/230-60-3	197/252	7.9	66.0	1	4.2	12.1	14.1	20
	F.L.	460-60-3*	414/506	4.8	39.0	1	3.4	8.2	9.4	15
SY036	G.J.	208/230-60-1	197/252	14.6	76.0	1	5.9	20.5	24.2	35
	H.K.	208/230-60-3	197/252	8.6	70.0	1	5.9	14.5	16.7	20
	F.L.	460-60-3*	414/506	4.5	39.0	1	4.8	9.3	10.4	15
SY042	G.J.	208/230-60-1	197/252	18.2	37.0	1	5.9	24.1	28.7	45
	H.K.	208/230-60-3	197/252	11.5	114.0	1	5.9	17.4	20.3	30
	F.L.	460-60-3*	414/506	6.5	56.0	1	4.8	11.3	12.9	15
SY048	G.J.	208/230-60-1	197/252	18.3	138.0	1	5.9	24.2	28.8	45
	H.K.	208/230-60-3	197/252	11.2	112.0	1	5.9	17.1	19.9	30
	F.L.	460-60-3*	414/506	6.8	61.8	1	4.8	11.6	13.3	15
SY060	G.J.	208/230-60-1	197/252	22.3	149.0	1	7.5	29.8	35.4	50
	H.K.	208/230-60-3	197/252	14.0	150.0	1	7.5	21.5	25.0	35
	F.L.	460-60-3*	414/506	6.3	58.0	1	6.2	12.5	14.1	20

Notes:

- All fuses Class RK-5.

***NEUTRAL CONNECTION REQUIRED! All F and L voltage (460VAC) units with CV EC motor require a four-wire power supply with neutral. CV EC motor is rated 265VAC and is wired between one hot leg and neutral.**

GENERAL

Furnish and install ClimateMaster Tranquility® SY water-source heat pumps, as indicated on the plans. Equipment shall be completely assembled, piped, and internally wired. Capacities and characteristics as listed in the schedule and the specifications that follow.

Units shall be supplied completely factory built capable of operating over an entering water temperature range from 20° to 120°F (-6.7° to 48.9°C) as standard. Equivalent units from other manufacturers may be proposed provided approval to bid is given 10 days prior to bid closing. All equipment listed in this section must be rated and certified in accordance with Air-Conditioning, Heating and Refrigeration Institute/International Standards Organization (AHRI/ISO 13256-1). All equipment must be tested, investigated, and determined to comply with the requirements of the standards for Heating and Cooling Equipment UL 60335-2-40 4th Edition, UL 60335-1 6th Edition for the United States and Can/CSA C22.2 No. 60335-2-40:22, CAN/CSA C22.2 No 60335-1:16 for Canada, by Intertek Testing Laboratories (ETL). The units shall have AHRI/ISO and ETL-US-C labels.

All units shall pass a factory acceptance test. The quality control system shall automatically perform the factory acceptance test via computer. A detailed report card from the factory acceptance test shall be shipped with each unit. **Note: If a unit fails the factory acceptance test, it shall not be allowed to ship. Unit serial number will be recorded by factory acceptance test and furnished on report card for ease of unit warranty status.**

BASIC CONSTRUCTION

Horizontal units shall have one of the following air flow arrangements: Left Inlet/Straight (Right) Discharge; Right Inlet/Straight (Left) Discharge; Left Inlet/Back Discharge; or Right Inlet/Back Discharge as shown on the plans. Units must have the ability to be field convertible from straight to back or back to straight discharge with no additional parts or unit structure modification. Horizontal units will have factory installed hanger brackets with rubber isolation grommets packaged separately.

Vertical units shall have one of the following air flow arrangements: Left Return/Top Discharge, Right Return/Top Discharge, as shown on the plans.

If units with these arrangements are not used, the contractor is responsible for any extra costs incurred by other trades. All units (horizontal and vertical) must have multiple access panels for serviceability of compressor compartment. **Units having only one access panel to compressor/heat exchangers/expansion device/refrigerant piping shall not be acceptable.**

Compressor section interior surfaces shall be lined with ½-inch (12.7 mm) thick, 1-½ lb/ft³ (24 kg/m³) acoustic type glass fiber insulation. Air handling section interior surfaces shall be lined with ½-inch (12.7 mm) thick, 1-½ lb/ft³ (24 kg/m³) **foil-faced**, glass-fiber insulation for ease of cleaning. Insulation placement shall be designed in a manner that will eliminate any exposed edges to prevent the introduction of glass fibers into the air stream. **Units without foil-faced insulation in the air handling section will not be accepted.**

The heat pump cabinets shall be fabricated from heavy gauge galvanized steel.

Standard insulation must meet NFPA Fire Hazard Classification requirements 25/50 per ASTM E84, UL 723, CAN/ULC S102-M88 and NFPA 90A requirements; air erosion and mold growth limits of UL 181; stringent fungal resistance test per ASTM-C1071 and ASTM G21; and shall meet zero level bacteria growth per ASTM G22. **Unit insulation must meet these stringent requirements or unit(s) will not be accepted.**

All horizontal units to have factory installed 1-inch (25.4 mm) discharge air duct collars, 1-inch (25.4 mm) filter rails with 1-inch (25.4 mm) filters factory installed, and factory installed unit-mounting brackets. Vertical units to have field installed discharge air duct collar, shipped loose and 1-inch (25.4 mm) filter rails with 1-inch (25.4 mm) filters factory installed. **If units with these factory-installed provisions are not used, the contractor is responsible for any extra costs to field install these provisions, and/or the extra costs for his subcontractor to install these provisions.**

ClimateMaster works continually to improve its products. As a result, the design and specifications of each product at the time of order may be changed without notice and may not be as described herein. Please contact ClimateMaster's Customer Service Department at 800-299-9747 for specific information on the current design and specifications. Statements and other information contained herein are not express warranties and do not form the basis of any bargain between the parties, but are merely ClimateMaster's opinion or commendation of its products. The latest version of this document is available at www.climatemaster.com. Engineered and assembled in the USA. © ClimateMaster, Inc. All Rights Reserved 2024

All units must have an insulated panel separating the fan compartment from the compressor compartment. **Units with the compressor in the air stream are not acceptable.** Units shall have a factory installed 1-inch (25.4 mm) wide filter bracket for filter removal from either side. Units shall have a 1-inch (25.4 mm) thick throwaway type glass fiber filter. **The contractor shall purchase one spare set of filters and replace factory shipped filters on completion of startup.** Filters shall be standard sizes. **If units utilize non-standard filter sizes, then the contractor shall provide 12 spare filters for each unit.**

Cabinets shall have separate holes and knockouts for entrance of line voltage and low voltage control wiring. All factory-installed wiring passing through factory knockouts and openings shall be protected from sheet metal edges at openings by plastic ferrules. Supply- and return-water connections shall be copper FPT fittings. All water connections and electrical knockouts must be in the compressor compartment corner post as to not interfere with the serviceability of unit. **Contractors shall be responsible for any extra costs involved in the installation of units that do not have this feature.** Contractors must ensure that units can be easily removed for servicing and coordinate locations of electrical conduit and lights with the electrical contractor.

Option: The unit will be supplied with optional field or factory installed 2-inch air filter rails (typically used for free return installation) or 1-inch or 2-inch air filter frames with filter access door and return air duct flanges (typically used for ducted return installation). **A corresponding 1-inch or 2-inch throwaway type glass fiber filter will ship with the factory installed filter rails or frame.**

Option: The contractor shall install 1-inch or 2-inch MERV-rated pleated media disposable air filters on all units.

Option: UltraQuiet package shall consist of high technology sound attenuating material that is strategically applied to the compressor and air handling compartment casings and fan scroll in addition to the standard ClimaQuiet system design, to further dampen and attenuate sound transmissions.

Option: The unit shall be supplied with extended range insulation option, which adds closed cell insulation to internal water lines, and provides insulation on suction side refrigeration tubing including refrigerant to water heat exchanger.

BLOWER AND MOTOR ASSEMBLY

Blowers shall have inlet rings to allow removal of wheel and motor from one side without removing housing. Units shall have a direct-drive centrifugal fan. The fan motor shall be an EC variable speed ball bearing type motor. The EC fan motor shall provide soft starting, maintain constant CFM over its static operating range and provide airflow adjustment in 25 CFM increments via its control board. The fan motor shall be isolated from the housing by rubber grommets. The motor shall be permanently lubricated and have thermal-overload protection. A special dehumidification mode shall be provided to allow lower airflows in cooling for better dehumidification. The dehumidification mode may be constant or automatic (humidistat controlled). Airflow/Static pressure rating of the unit shall be based on a wet coil and a clean filter in place. **Ratings based on a dry coil, and/or no air filter, shall NOT be acceptable.**

REFRIGERANT CIRCUIT

All units shall contain an R-454B sealed refrigerant circuit including a high efficiency scroll or rotary compressor designed for heat pump operation, a thermostatic expansion valve for refrigerant metering, an enhanced corrugated aluminum lanced fin and rifled copper tube refrigerant to air heat exchanger, reversing valve, coaxial (tube in tube) refrigerant to water heat exchanger, and safety controls including a high-pressure switch, low-pressure (loss-of-charge) switch, water coil low-temperature sensor, and air coil low-temperature sensor. Access fittings shall be factory installed on high- and low-pressure refrigerant lines to facilitate field service. Activation of any safety device shall prevent compressor operation via a microprocessor lockout circuit. The lockout circuit shall be reset at the thermostat or at the contractor-supplied disconnect switch. **Units that cannot be reset at the thermostat shall not be acceptable.**

Hermetic compressors shall be internally sprung. The compressor shall have a dual level vibration isolation system. The compressor will be mounted on specially engineered sound-tested EPDM vibration isolation grommets to a large heavy gauge compressor mounting plate, which is then isolated from the cabinet base with EPDM grommets for maximized vibration attenuation. All units shall include a discharge muffler to further enhance sound attenuation. Compressors shall have thermal-overload protection. Compressors shall be located in an insulated compartment away from air stream to minimize sound transmission.

Refrigerant to air heat exchangers shall utilize enhanced corrugated lanced aluminum fins and rifled copper tube construction rated to withstand 625 PSIG (4309 kPa) refrigerant working pressure. Refrigerant to water heat exchangers shall be of copper inner water tube and steel refrigerant outer tube design, rated to withstand 625 PSIG (4309 kPa) working refrigerant pressure and 500 PSIG (3445 kPa) working water pressure. The refrigerant to water heat exchanger shall be "electro-coated" with a low cure cathodic epoxy material a minimum of 0.4 mils thick (0.4 – 1.5 mils range) on all surfaces. The black colored coating shall provide a minimum of 1,000-hour salt spray protection per ASTM B117-97 on all external steel and copper tubing. The material shall be formulated without the inclusion of any heavy metals and shall exhibit a pencil hardness of 2H (ASTM D3363-92A), crosshatch adhesion of 4B-5B (ASTM D3359-95), and impact resistance of 160 in-lbs (184 kg-cm) direct (ASTM D2794-93).

Refrigerant metering shall be accomplished by thermostatic expansion valve only. Expansion valves shall be dual port balanced types with external equalizer for optimum refrigerant metering. Units shall be designed and tested for operating ranges of entering water temperatures from 20° to 120°F (-6.7° to 48.9°C). The reversing valve shall be four-way solenoid activated refrigerant valve, which shall default to heating mode should the solenoid fail to function. If the reversing valve solenoid defaults to cooling mode, an additional low-temperature thermostat must be provided to prevent over-cooling an already cold room.

Units charged with 62 ounces or greater of R-454B shall be supplied with a Refrigerant Detection System (RDS) with sensors to be strategically placed within the cabinet. In the event of a refrigerant leak, the RDS disables compressor operation, and the unit blower runs to disperse any concentration of leaked refrigerant in compliance with UL 60335-2-40 safety standards for flammable refrigerants. **Units charged with 62 ounces or greater of R-454B that do not have an RDS shall not be acceptable.**

Option: The unit will be supplied with a cupro-nickel coaxial water to refrigerant heat exchanger.

Option: The refrigerant to air heat exchanger shall be tin-plated.

Option: The Refrigerant Detection System (RDS) package shall consist of the RDS module and sensors to be strategically placed within the cabinet. In the event of a refrigerant leak, the RDS triggers an alert through the DDC control system, disables compressor operation, and the unit blower runs to disperse any concentration of leaked refrigerant in compliance with UL 60335-2-40 safety standards for flammable refrigerants (Optional for sizes 024-048).

DRAIN PAN

The drain pan shall be constructed of corrosion resistant polymer material. The drain outlet shall be connected from pan using provided polymer coupling and clamps that meet UL 2043 as required for discrete products by the IMC and UMC when located in a plenum. If steel material is used for drain pan it shall be fully insulated on all sides and must meet the stringent 1,000-hour salt spray test per ASTM B117. Drain outlet shall be located at pan as to allow unobstructed drainage of condensate. Drain outlet shall be connected from pan directly to plumbing via a rubber coupling that couples to ¾-inch schedule 40/80 PVC fitting. No hidden internal tubing extensions from pan outlet extending to unit casing (that can create drainage problems) will be accepted. The unit as standard will be supplied with solid-state electronic condensate overflow protection. **Mechanical float switches will NOT be accepted.**

Option: The drain pan shall be constructed of 304 stainless steel and drain connection will be ¾-inch MPT. The stainless-steel drain pan shall be fully insulated on all sides.

ELECTRICAL

A control box shall be located within the unit compressor compartment and shall contain a 75VA transformer, 24V activated, two or three-pole compressor contactor, terminal block for thermostat wiring and solid-state controller for complete unit operation. The control box on sizes 024 through 060 shall have a door to protect the internal components. The entire control box shall be capable of rotating out of the unit to allow access to the components behind the control box. Low voltage wires shall enter the box through a hole in the lower left side and high voltage wires shall enter the box through a hole in the upper left side. Reversing valve and blower motor wiring shall be routed through this electronic controller. Units shall be name-plated for use with time delay fuses or HACR circuit breakers. Unit controls shall be 24V and provide heating or cooling as required by the remote thermostat/sensor.

Option: Disconnect Switch, Non-Fused, classified as motor disconnect

SOLID STATE CONTROL SYSTEM (DXM2.5)

Units shall have a solid-state control system. Units utilizing electro-mechanical control shall not be acceptable. The control system microprocessor board shall be specifically designed to protect against building electrical system noise contamination, EMI, and RFI interference. The control system shall have the following features:

- a. Anti-short cycle time delay on compressor operation.
- b. Random start on power-up mode.
- c. Low-voltage protection.
- d. High-voltage protection.
- e. Unit shutdown on high- or low-refrigerant pressures.
- f. Unit shutdown on low water temperature.
- g. Condensate-overflow electronic protection.
- h. Option to reset unit at thermostat or disconnect.
- i. Automatic intelligent reset. Unit shall automatically reset the unit 5 minutes after trip if the fault has cleared. If a fault occurs three times sequentially without thermostat meeting temperature, then lockout requiring manual reset will occur.
- j. Ability to defeat time delays for servicing.
- k. Light emitting diode (LED) on circuit board to indicate high pressure, low pressure, low voltage, high voltage, low water/air temperature cut-out, condensate overflow, and control voltage status.
- l. The low-pressure switch shall not be monitored for the first 120 seconds after a compressor start command to prevent nuisance safety trips.
- m. 24V output to cycle a motorized water valve or other device with compressor contactor.
- n. Unit Performance Sentinel (UPS). The UPS warns when the heat pump is running inefficiently.
- o. Water coil low-temperature sensing (selectable for water or antifreeze).
- p. Air coil low-temperature sensing.
- q. Removable thermostat connector.
- r. Night setback control.
- s. Random start on return from night setback.
- t. Minimized reversing-valve operation (Unit control logic shall only switch the reversing valve when cooling is demanded for the first time. The reversing valve shall be held in this position until the first call for heating, ensuring quiet operation and increased valve life.).
- u. Override temperature control with 2-hour timer for room occupant to override setback temperature at the thermostat.
- v. Dry contact night setback output for digital night setback thermostats.
- w. Ability to work with heat pump (Y, O) or heat/cool (Y, W) type thermostats.
- x. Ability to work with heat pump thermostats using O or B reversing valve control.
- y. Emergency-shutdown contacts.
- z. Boilerless system heat control at low loop water temperature.

- aa. Ability to allow up to three units to be controlled by one thermostat.
- ab. Relay to operate an external damper.
- ac. Ability to automatically change fan speed from multi-stage thermostat.
- ad. Relay to start system pump.
- ae. 75VA control transformer. Control transformer shall have load side short circuit and overload protection via a built in circuit breaker.

NOTE: Units not providing the eight safety protections of anti-short cycle, low voltage, high voltage, high refrigerant pressure, low pressure (loss of charge), air coil low temperature cut-out, water coil low temperature cut-out, and condensate overflow protections will not be accepted.

NOTE: To achieve full benefit of the two-stage compressor and EC fan, a 2-Heat/2-Cool thermostat (or a 3-Heat/2-Cool thermostat when electric backup heat is required) should be employed.

When DXM2.5 is connected to AWC99U01 communicating thermostat or handheld service tool, the installer/service technician can; check and set CFM and check DIP switch S1, S2, and S3 settings; run operation modes manually; check all physical inputs from thermostat and refrigerant pressure switches status, (Y1, Y2, W, O, G, H, ESD, NSB, OR, HP switch, and LOC switch); current or at time of fault the following temperatures - water coil (LT1), air coil (LT2), compressor discharge, leaving air, leaving water, entering water and control voltage; record last five faults, list possible reasons, and clear faults. When the AWC99U01 communicating thermostat is used this same functionality can be viewed and adjusted remotely with the only portal or mobile app. Systems not providing remote access, diagnosis, and adjustment functionality will not be accepted.

This control system coupled with a multi-stage thermostat will better dehumidify room air by automatically running the heat pump's fan at lower speed on the first stage of cooling thereby implementing low sensible heat ratio cooling. On the need for higher cooling performance the system will activate the second stage of cooling and automatically switch the fan to the higher fan speed setting.

This system may be further enhanced with a humidistat. Units not having automatic low sensible heat ratio cooling will not be accepted; as an alternate a hot gas reheat coil may be provided with a control system for automatic activation.

DIGITAL NIGHT SETBACK WITH PUMPRESTART (DXM2.5 WITH ATP32U03C/04C, AWC99U01)

The unit will be provided with a Digital Night Setback feature using an accessory relay on the DXM2.5 controller with an ATP32U03C/04C or AWC99U01 thermostat and an external, field-provided time clock. The external time clock will initiate and terminate the night setback period. The thermostat will have a night setback override feature with a programmable override time period. An additional accessory relay on the unit DXM2.5 controller will energize the building loop pump control for the duration of the override period. (Note: This feature requires additional low voltage wiring. Consult Application Drawings for details.)

REMOTE SERVICE SENTINEL

The solid-state control system shall communicate with thermostat to display (at the thermostat) the unit status, fault status, and specific fault condition, as well as retrieve previously stored fault that caused unit shutdown. The Remote Service Sentinel allows building maintenance personnel or service personnel to diagnose units from the wall thermostat. The control board shall provide a signal to the thermostat fault light, indicating a lockout. Upon cycling the G (fan) input three times within a 60 second time period, the fault light shall display the specific code as indicated by a sequence of flashes. A detailed flashing code shall be provided at the thermostat LED to display unit status and specific fault status such as over/under voltage fault, high pressure fault, low pressure fault, low water temperature fault, condensate overflow fault, etc. Units that do not provide this remote service sentinel shall not be acceptable.

Option: MPC (Multiple Protocol Control) Interface System

Units shall have all the features listed above and the control board will be supplied with a Multiple Protocol interface board. Available protocols are BACnet MS/TP, Modbus, or Johnson Controls N2. The choice of protocol shall be field selectable/changeable via the use of a simple selector switch. Protocol selection shall not require any additional programming or special external hardware or software tools. This will permit all units to be daisy chain connected by a 2-wire twisted pair shielded cable. The following points must be available at a central or remote computer location:

- a. Space temperature.
- b. Leaving-water temperature.
- c. Discharge-air temperature.
- d. Command-of-space temperature setpoint.
- e. Cooling status.
- f. Heating status.
- g. Low-temperature sensor alarm.
- h. Low-pressure sensor alarm.
- i. High-pressure switch alarm.
- j. Condensate-overflow alarm.
- k. High-/low-voltage alarm.
- l. Fan "ON/AUTO" position of space thermostat as specified above.
- m. Unoccupied / occupied command.
- n. Cooling command.
- o. Heating command.
- p. Fan "ON/AUTO" command.
- q. Fault-reset command.
- r. Itemized fault code revealing reason for specific shutdown fault (any one of seven).

WARRANTY

ClimateMaster shall warranty equipment for a period of 12 months from start up or 18 months from shipping (whichever occurs first).

Option: Extended 4-year compressor warranty covers compressor for a total of 5 years.

Option: Extended 4-year refrigeration circuit warranty covers coils, reversing valve, expansion valve and compressor for a total of 5 years.

Option: Extended 4-year control board warranty covers the DXM2.5 control board for a total of 5 years.

FIELD-INSTALLED OPTIONS

Hose Kits

All units shall be connected with hoses. The hoses shall be 2-feet (61 cm) long, braided stainless steel; fire rated hoses complete with adapters. Only fire rated hoses will be accepted.

Valves

The following valves are available and will be shipped loose:

- a. Ball valve; bronze material, standard port full flow design, FPT connections.
- b. Ball valve with memory stop and PT port.
- c. "Y" strainer with blowdown valve; bronze material, FPT connections.
- d. Motorized water valve; slow acting, 24V, FPT connections.
- e. Hose Kit Assemblies
- f. The following assemblies ship with the valves already assembled to the hose described:
- g. Supply and return hoses having ball valve with PT port.
- h. Supply hose having ball valve with PT port; return hose having automatic flow regulator valve with PT ports, and ball valve.
- i. Supply hose having "Y" strainer with blowdown valve, and ball valve with PT port; return hose having automatic flow regulator with PT ports, and ball valve.
- j. Supply hose having "Y" strainer with blowdown valve, and ball valve with PT port; return hose having ball valve with PT port.

THERMOSTATS

The thermostat shall be a ClimateMaster mechanical or electronic type thermostat as selected below with the described features:

a. Thermostat (Communicating) (AWC99U01)

An electronic communicating web-enabled touchscreen thermostat shall be provided. The thermostat shall offer three stages of heating and two stages of cooling with precise temperature control and have a four-wire connection to the unit. The thermostat shall be capable of manual or automatic change-over operation and shall operate in standard or programmable mode. An integrated humidity control feature shall be included to control a humidifier and/or a dehumidifier. The thermostat shall include a utility demand reduction feature to be initiated by an independent time program or an external input. The thermostat shall provide access to via the web portal or mobile application to include temperature adjustment, schedule adjustment including occupied/unoccupied, entering-water temperature, leaving-water temperature, water-coil temperature, air-coil temperature, leaving-air temperature, and compressor-discharge temperature. A graphical system layout to be provided with real-time operating mode information of the temperature sensors for easy diagnostics. The thermostat shall display system faults with probable cause and troubleshooting guidance.

The system shall provide in clear language the last five faults, time of faults, operating temps at time of fault, and possible reasons for the fault. The thermostat shall provide access for immediate manual control of all outputs via the web portal/mobile application for rapid troubleshooting.

b. CM500 – Color-Touchscreen Display, Multi-stage, Automatic or Manual Changeover, 7-day Programmable with Wi-Fi and Humidity Control (AVB32V03C/R)

The thermostat shall have color-resistive touchscreen display with space temperature, relative humidity, setpoints, mode, status indication and local weather (if connected to Wi-Fi). Residential version shall be 7-day programmable with up to four setpoints per day. The commercial version shall be 7-day programmable with four occupied/unoccupied periods per day with up to 4-hour override. Multi-stage (3H/2C), automatic or manual changeover with HEAT-OFF-COOL-AUTO-EM HEAT system settings and fan ON-AUTO settings, Wi-Fi, pre-occupancy purge fan option, customizable screen saver and background displays, indicator-on display indicates a heating or cooling demand, setpoint lock, title 24 compliant, openADR2.0b certified with Skyport web portal. Compatible with condensate-overflow warning systems – lockout compressor with message on the display. Capable of being monitored by third-party software. Compatible with AST014 Wi-Fi remote sensor. Configurator mobile app or web portal for easy setup. Separate dehumidification and humidification setpoints shall be configurable for discreet outputs to a dehumidification option and/or an external humidifier. The temperature indication shall be selectable for °F or °C. Time display shall be selectable for 12- or 24-hour clock. The thermostat shall provide permanent memory of setpoints without batteries. The thermostat shall provide heating setpoint-range limit, cooling setpoint-range limit, temperature display offset, dead-band range setting, and inter-stage differential settings. The thermostat shall provide progressive recovery to anticipate time required to bring space temperature to the next programmed event. The thermostat shall provide access to a web portal and mobile app for installer setup for configuring options. The thermostat shall have menu-driven selections for ease-of-use and programming.

c. CM300 – Multi-stage, Automatic or Manual Changeover, 7-day Programmable with Wi-Fi and Humidity Control (AVB32V02C/R)

The residential version shall be 7-day programmable with up to four setpoints per day. The commercial version shall be 7-day programmable with four occupied/unoccupied periods per day with up to 4-hour override. Multi-stage (3H/2C), automatic or manual changeover with HEAT-OFF-COOL-AUTO-EM HEAT system settings and fan ON-AUTO settings, Wi-Fi, pre-occupancy purge fan option, nighttime control of display backlight, bi-color LED indicates a heating or cooling demand, keypad lock, title 24 compliant, openADR2.0b certified with Skyport web portal. Compatible with condensate-overflow warning systems – lockout compressor with message on.

d. CM100 – Multi-stage Automatic or Manual Changeover digital thermostat (ATA32V01)

Multi-stage (3H/2C), automatic or manual changeover with HEAT-OFF-COOL-AUTO-EM HEAT system settings and fan ON-AUTO settings. The thermostat shall have a green backlit LED display with temperature, setpoints, mode, and status indication via a green (cooling) or red(heating) LED. The temperature indication shall be selectable for °F or °C. Time display shall be selectable for 12- or 24-hour clock. The thermostat shall provide permanent memory of setpoints without batteries. The thermostat shall provide heating-setpoint range limit, cooling-setpoint range limit, temperature display offset, keypad lockout, dead-band range setting, and inter-stage differential settings. The thermostat shall provide progressive recovery to anticipate time required to bring space temperature to the next programmed event. The thermostat shall provide an installer setup for configuring. Thermostat navigation shall be accomplished via four buttons (Mode/fan/down/up) with menu-driven selections for ease of use and programming.

e. Multi-stage Digital Automatic Changeover (ATA22U01)

The thermostat shall be multi-stage (2H/2C), manual or automatic changeover with HEAT-OFF-COOL-AUTO-EM HEAT system settings and fan ON-AUTO settings. The thermostat shall have an LCD display with temperature, setpoint(s), mode, and status indication. The temperature indication shall be selectable for °F or °C. The thermostat shall provide permanent memory of setpoint(s) without batteries. A fault LED shall be provided to indicate specific fault condition(s). The thermostat shall provide temperature-display offset for custom applications. The thermostat shall allow unit to provide better dehumidification by automatically using lower fan speed on stage-1 cooling (higher latent cooling) as main cooling mode, and automatically shifting to high-speed fan on stage-two cooling.

f. Multi-stage Automatic or Manual Changeover Programmable 7-Day (ATP32U03C)

The thermostat shall be 7-day programmable (with up to four setpoints per day), multi-stage (3H/2C), automatic or manual changeover with HEAT-OFF-COOL-AUTO-EM HEAT system settings and fan ON-AUTO settings. The thermostat shall have a blue backlit dot matrix LCD display with temperature, setpoints, mode, and status indication. The temperature indication shall be selectable for °F or °C. Time display shall be selectable for 12- or 24-hour clock. Fault identification shall be provided to simplify troubleshooting by providing specific unit fault at the thermostat with red backlit LCD during unit lockout. The thermostat shall provide permanent memory of setpoints without batteries. The thermostat shall provide heating-setpoint range limit, cooling-setpoint range limit, temperature display offset, keypad lockout, dead-band range setting, and inter-stage differential settings. The thermostat shall provide progressive recovery to anticipate time required to bring space temperature to the next programmed event. The thermostat shall provide an installer setup for configuring options and for setup of servicing contractor name and contact information.

DDC SENSORS

The thermostat shall allow the use of an accessory remote and/or outdoor-temperature sensor (AST008). Thermostat navigation shall be accomplished via five buttons (up/down/right/left/select) with menu-driven selections for ease of use and programming.

g. Multi-stage Automatic or Manual Changeover Programmable 7-Day with Humidity Control (ATP32U04C)

The thermostat shall be 7-day programmable (with up to four setpoints per day), multi-stage (3H/2C), automatic or manual changeover with HEAT-OFF-COOL-AUTO-EM HEAT system settings and fan ON-AUTO settings. Separate dehumidification and humidification setpoints shall be configurable for discreet outputs to a dehumidification option and/or an external humidifier. Installer configuration mode shall allow the thermostat to operate with EC fan dehumidification mode via settings changes. The thermostat shall have a blue backlit dot matrix LCD display with temperature, relative humidity, setpoints, mode, and status indication. The temperature indication shall be selectable for °F or °C. Time display shall be selectable for 12- or 24-hour clock. Fault identification shall be provided to simplify troubleshooting by providing specific unit fault at the thermostat with red backlit LCD during unit lockout. The thermostat shall provide permanent memory of setpoints without batteries. Thermostat shall provide heating setpoint range limit, cooling setpoint range limit, temperature display offset, keypad lockout, dead-band range setting, and inter-stage differential settings. The thermostat shall provide progressive recovery to anticipate time required to bring space temperature to the next programmed event. The thermostat shall provide an installer setup for configuring options and for setup of servicing contractor name and contact information. The thermostat shall allow the use of an accessory remote and/or outdoor temperature sensor (AST008). Thermostat navigation shall be accomplished via five buttons (up/down/right/left/select) with menu-driven selections for ease of use and programming.

ClimateMaster wall mounted DDC sensor to monitor room temperature and interfaces with optional interface system described above. Several types as described below:

- k. Sensor only with no display (MPC).
- l. Sensor with setpoint adjustment and override (MPC only).
- m. Sensor with setpoint adjustment and override, LCD display, status/fault indication (MPC).

NOTICE! This product specification document is furnished as a means to copy and paste ClimateMaster product information into project specification. It is not intended to be a complete list of product requirements. This document is an excerpt from the product submittal and must not be used without consulting the complete product submittal. For complete product installation and application requirements, please consult the complete product submittal. ClimateMaster is not responsible for misuse of this document or a failure to adequately review specific requirements in the product catalog.

Revision History

Models:
SY
024-060

Date	Section	Description
08/08/24	Minimum Installation Area	Updated Minimum Installation Area data
	Physical Data	Updated Unit Maximum Water Working Pressure
07/11/24	Performance Data	Updated the product's AHRI ratings
01/18/24	All	Created



A NIBE GROUP MEMBER

7300 SW 44th St. | Oklahoma City, OK 73179

Phone: 800.299.9747

www.climatemaster.com



ClimateMaster works continually to improve its products. As a result, the design and specifications of each product at the time of order may be changed without notice and may not be as described herein. Please contact ClimateMaster's Customer Service Department at 800-299-9747 for specific information on the current design and specifications. Statements and other information contained herein are not express warranties and do not form the basis of any bargain between the parties, but are merely ClimateMaster's opinion or commendation of its products. The latest version of this document is available at www.climatemaster.com. Engineered and assembled in the USA. © ClimateMaster, Inc. All Rights Reserved 2024