

Tranquility® Large Water-To-Water (TMW) Series

Submittal Data

Models TMW360 - 840 60Hz - HFC-410A



LC975

Rev.: May 11, 2023



Table of Contents

TMW Large Series

Introduction	3
Features, Options and Accessories	4
Selection Procedure	5
TMW Large Series Nomenclature	7
Performance Data – AHRI/ASHRAE/ISO 13256-2	8
Performance Data – TMW360 (60Hz I-P) - Cooling	9
Performance Data – TMW360 (60Hz I-P) - Heating	10
Performance Data – TMW600 (60Hz I-P) - Cooling	11
Performance Data – TMW600 (60Hz I-P) - Heating	12
Performance Data – TMW840 (60Hz I-P) - Cooling	13
Performance Data – TMW840 (60Hz I-P) - Heating	14
Antifreeze Correction Table	15
Physical & Electrical Data	17
Dimensional Data – TMW360-840	18
TMW Large Series – Wiring Diagram Matrix and Sound Power Data	19
TMW Large Series – Typical Wiring Diagram	20
Engineering Specifications	23
Performance Sheet	27
Revision History	29



Document page number is shown next to part number (e.g. LC975 - 3 = page 3). Since not all pages are typically used in the submittals process, the page number in the lower right corner can still be used (page ____ of ____).

ClimateMaster works continually to improve its products. As a result, the design and specifications of each product at the time of order may be changed without notice and may not be as described herein. Please contact ClimateMaster's Customer Service Department at 1-405-745-6000 for specific information on the current design and specifications. Statements and other information contained herein are not express warranties and do not form the basis of any bargain between the parties, but are merely ClimateMaster's opinion or commendation of its products. The latest version of this document is available at climatemaster.com. © ClimateMaster, Inc. All rights reserved 2011

THE TRANQUILITY® LARGE WATER-TO-WATER (TMW) SERIES

The Tranquility® Large Water-to-Water (TMW) Series offers high efficiency and high capacity with advanced features, quiet operation and application flexibility at competitive prices. As ClimateMaster's largest water-to-water unit, the TMW Large Series can be used for radiant floor heating, snow/ice melt, chilled or hot water for fan coils, industrial process control, potable hot water generation (requires field supplied secondary heat exchanger), hot/chilled water for make-up air, and many other types of HVAC and industrial applications that require cost effective heated or chilled water.

The Tranquility® Large Water-to-Water (TMW) Series exceeds ASHRAE 90.1 efficiencies, and also uses EarthPure® (HFC-410A) zero ozone depletion refrigerant, making it an extremely environmentally-friendly option. The unit is eligible for additional LEED® (Leadership in Energy and Environmental Design) points because of the "green" technology design.

Available in 30, 50, and 70 ton capacities (105.6 kW, 176 kW, and 246 kW), the TMW Large Series provides high capacity in a small footprint, which saves mechanical room space. The TMW Large Series has an extended range refrigerant circuit (refrigerant and water circuit insulation is standard), capable of ground loop (geothermal) applications as well as water loop (boiler-tower) applications. Standard features are many. Microprocessor controls, galvanized steel cabinet, polyester powder coat paint, and TXV refrigerant metering device are just some of the features of the flexible TMW Large Series. The brazed plate heat exchangers constructed of 316 stainless steel are designed for many years of reliable operation.

Scroll compressors operate quietly, and provide part load operation for capacity control. For ease of installation and service, access to the refrigeration service and electrical control panel is located at the front of the unit, allowing units to be installed side-by-side for large capacity applications.

TMW 360, 600, 840 are designed for single unit applications. TMW multiple units do not communicate from unit to unit.

The TMW Series water-to-water heat pumps are designed to meet the challenges of today's HVAC demands with a high efficiency, high value solution.

Features, Options and Accessories

FEATURES

- Sizes 360 (30 tons, 105.6 kW), 600 (50 tons, 176 kW), and 840 (70 tons, 246 kW)
- Copeland scroll compressor(s)
- Dual independent refrigeration circuits
- Exceeds ASHRAE 90.1 efficiencies
- Brazed plate heat exchanger for both source and load
- Exclusive front and back service access allows multiple units to be installed side-by-side for large capacity installations
- Top water connections, staggered for ease of manifolding multiple units
- Fully insulated water and refrigerant circuits
- Heavy gauge galvanized steel construction with polyester powder coat paint
- Insulated compressor compartment
- Small footprint
- TXV metering devices
- Extended range (30 to 120°F, -1.1 to 48.9°C) operation
- Microprocessor controls standard
- Lights on the front of the cabinet indicate unit power, fault, compressor 1 and 2 in operation
- Eleven safeties standard to protect the compressors and brazed plate heat exchangers
- Differential pressure sensors (2) for proof of water flow for Load and Source, factory installed
- BACnet compatibility for DDC controls

OPTIONS

- Motorized valve on Load side
- Motorized water valves on Source and Load sides

ACCESSORIES

- BACview 6 controller must be used to set up unit controller at start up. Also can be used to monitor, change default settings, or service unit
- 60 Mesh Y and basket strainers to mount external of unit

Selection Procedure

Reference Calculations

HEATING	
$LWT = EWT - \frac{HE}{GPM \times 500}$	

COOLING	
$LWT = EWT + \frac{HR}{GPM \times 500}$	

Conversion Table - to convert inch-pound (English) to S-I (Metric)

Water Flow	Water Pressure Drop
Water Flow (L/s) = gpm x 0.0631	PD (kPa) = PD (ft of hd) x 2.99

Legend and Glossary of Abbreviations

Abbreviations	Descriptions
BTUH	BTU (British Thermal Unit) per hour
CDT	Compressor discharge temperature
CFM	Airflow, cubic feet per minute
COP	Coefficient of performance = BTUH output/BTUH input
CT ECM	Electronic commutated constant torque fan motor
CV ECM	Electronic commutated constant volume fan motor
DB	Dry bulb temperature, °F
EAT	Entering air temperature
EER	Energy efficient ratio = BTUH output/Watt input
ESP	External static pressure, inches w.g.
EWT	Entering water temperature
FPT	Female pipe thread
GPM	Water flow in U.S., gallons per minute
HC	Air heating capacity, BTUH
HE	Total heat of extraction, BTUH
HR	Total heat of rejection, BTUH
HWC	Hot water generator (desuperheater) capacity, Mbtuh
KW	Total power unit input, kilowatts
LAT	Leaving air temperature, °F
LC	Latent cooling capacity, BTUH
LOC	Loss of charge
LWT	Leaving water temperature, °F
MBTUH	1,000 BTU per hour
MPT	Male pipe thread
MWV	Motorized water valve
PSC	Permanent split capacitor
SC	Sensible cooling capacity, BTUH
S/T	Sensible to total cooling ratio
TC	Total cooling capacity, BTUH
TD or delta T	Temperature differential
VFD	Variable frequency drive
WB	Wet bulb temperature, °F
WPD	Waterside pressure drop, psi or feet of head
WSE	Waterside economizer

Selection Procedure

Step 1 Determine the actual heating and/or cooling loads at the applicable source water temperature/flow rate and load water temperature/flow rate. The source heat exchanger is the condenser in cooling/evaporator in heating; the load heat exchanger is the evaporator in cooling/condenser in heating.

Step 2 Obtain the following design parameters: Entering source/load water temperature, source/load water flow rate in GPM and water flow pressure drop. Water flow rate is generally between 2.25 and 3.00 GPM/ton for closed loop (boiler/tower and geothermal) systems, and between 1.5 and 2.0 GPM/ton for open loop (well water) systems. Unit water pressure drop should be kept as close as possible to each other to make water balancing easier. Go to the appropriate tables and find the proper indicated water flow and water temperature.

Step 3 Determine application requirements. Water-to-water applications are almost always designed for a particular installation, which will change how the data tables are used for unit selection. For example, a water-to-water unit used for radiant floor heating on a geothermal closed loop is significantly different in unit selection from a water-to-water unit on a boiler/tower application used for generating chilled water for fan coil units. It is especially important to note that the load water flow rate must be maintained above minimum flow rates as shown in the data tables for proper refrigerant circuit operation and unit longevity. For example, most radiant floor applications require buffer (storage) tanks because the flow rate through the floor is usually lower than the minimum flow rate for the water-to-water unit. Therefore, selection of the heat pump is dependent upon maintaining a certain tank temperature and unit load flow rate. There would be a pump between the heat pump and the buffer tank, and a pump(s) between the buffer tank and radiant floor to maintain design flow rate on both sides.

Step 4 Enter tables at the design source water temperature and flow rate. Choose the appropriate load water temperature and flow rate. Read the total heating or cooling capacities (Note: interpolation is permissible; extrapolation is not).

Step 5 If the units selected are not within 10% of the load calculations, then review what effect changing the GPM and water temperature would have on the capacities. If the desired capacity cannot be achieved, select the next larger or smaller unit and repeat the procedure.

Example Equipment Selection for Heating

Step 1 Load Determination:

Assume we have determined that the application will be heating only (radiant floor) for a large commercial warehouse, and that the appropriate heating load at design conditions is as follows:

Total Heating 480,000 BTUH

Step 2 Design Conditions:

Entering source temperature.....30°F (geothermal closed loop)

Source flow rate 113 GPM

Entering load temperature..... 130°F

Load flow rate 113 GPM

Steps 3, 4, 5 HP Selection:

We enter the tables at design source water temperature and flow rate, and select the appropriate load water temperature and flow rate. A TMW600 at design conditions supplies 479,100 BTUH, which meets the design heating load requirement.

TMW Large Series Nomenclature

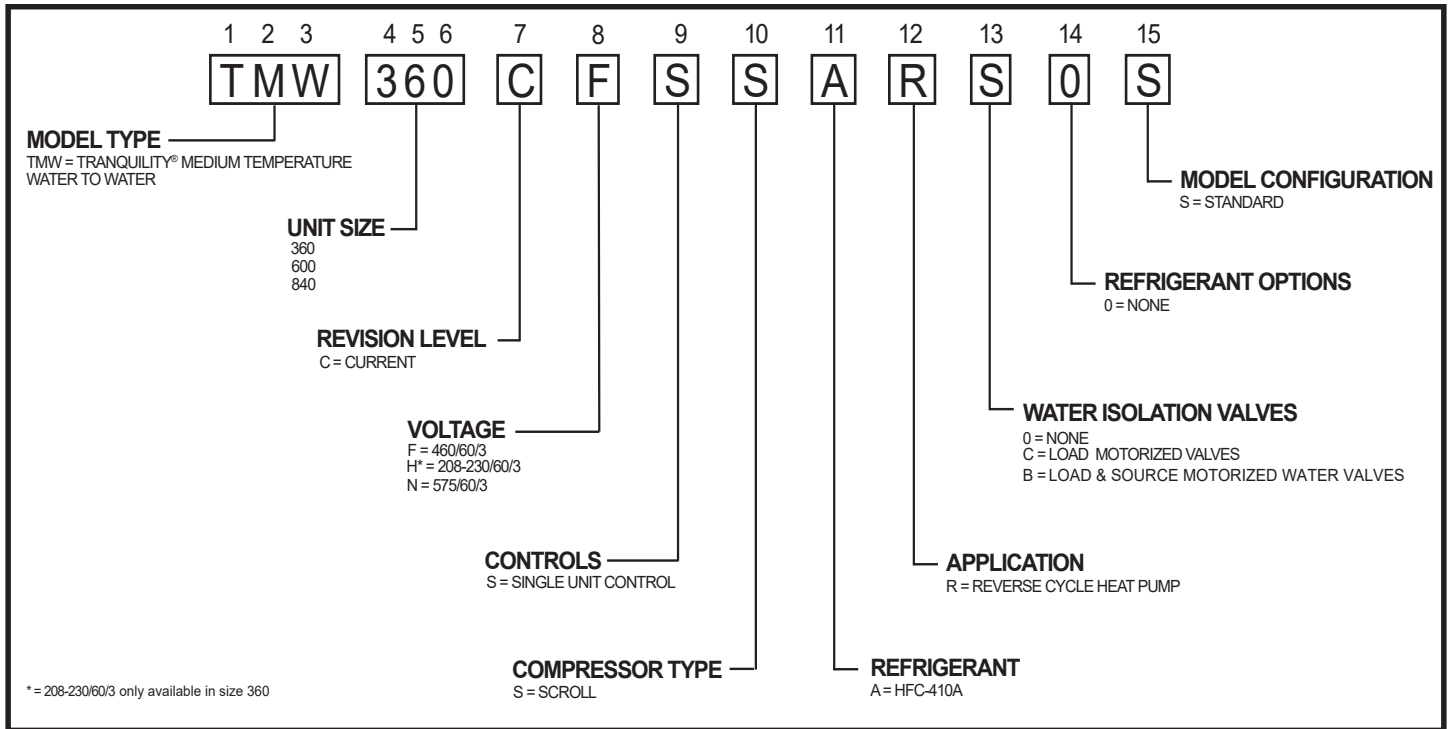

Performance Data – AHRI/ASHRAE/ISO 13256-2

TMW360-840 Performance Data in Accordance With ASHRAE/AHRI/ISO 13256-2 English (I-P) Units

Model	Water Loop Heat Pump				Ground Water Heat Pump				Ground Loop Heat Pump			
	Cooling		Heating		Cooling		Heating		Cooling		Heating	
	Indoor 53.6°F Outdoor 86°F		Indoor 104°F Outdoor 68°F		Indoor 53.6°F Outdoor 59°F		Indoor 104°F Outdoor 50°F		Indoor 53.6°F Outdoor 77°F		Indoor 104°F Outdoor 32°F	
	Capacity Btuh	EER Btuh/W	Capacity Btuh	COP	Capacity Btuh	EER Btuh/W	Capacity Btuh	COP	Capacity Btuh	EER Btuh/W	Capacity Btuh	COP
TMW360	380,300	16.00	531,000	5.10	438,000	24.20	416,000	4.20	399,600	18.40	316,000	3.40
TMW600	619,800	16.00	873,000	5.20	707,400	23.20	680,000	4.30	649,600	18.20	517,000	3.40
TMW840	814,800	16.20	1,141,000	5.30	925,700	23.30	894,000	4.40	852,600	18.40	677,000	3.40

All TMW360 performance data @ 90GPM Load w/90 GPM Source.
 All TMW600 performance data @ 150GPM Load w/150 GPM Source.
 All TMW840 performance data @ 210GPM Load w/210 GPM Source.
 All performance data based upon operation at lower voltage of dual voltage rated models.

TMW360-840 Performance Data in Accordance With ASHRAE/AHRI/ISO 13256-2 Metric (S-I) Units

Model	Water Loop Heat Pump				Ground Water Heat Pump				Ground Loop Heat Pump			
	Cooling		Heating		Cooling		Heating		Cooling		Heating	
	Indoor 12°C Outdoor 30°C		Indoor 40°C Outdoor 20°C		Indoor 12°C Outdoor 15°C		Indoor 40°C Outdoor 10°C		Indoor 12°C Outdoor 25°C		Indoor 40°C Outdoor 0°C	
	Capacity kW	EER W/W	Capacity kW	COP	Capacity kW	EER W/W	Capacity kW	COP	Capacity kW	EER W/W	Capacity kW	COP
TMW360	111.46	4.70	155.63	5.10	128.37	7.10	121.92	4.20	117.12	5.39	92.61	3.40
TMW600	181.65	4.70	255.86	5.20	207.33	6.80	199.30	4.30	190.39	5.33	151.52	3.40
TMW840	238.80	4.75	334.41	5.30	271.31	6.83	262.02	4.40	249.88	5.39	198.42	3.40

All TMW360 performance data @ 5.68 l/s Load w/5.68 l/s Source.
 All TMW600 performance data @ 9.47 l/s Load w/9.47 l/s Source.
 All TMW840 performance data @ 13.25 l/s Load w/13.25 l/s Source.
 All performance data based upon operation at lower voltage of dual voltage rated models.

Performance Data – TMW600 (60Hz I-P) - Heating

Source				LOAD									SLWT	LOAD									SLWT	LOAD									SLWT
EWT °F	Flow			EWT °F	Flow 75 GPM						°F	Flow 113 GPM						°F	Flow 150 GPM						°F								
	GPM	WPD PSI	FT		TC	kW	HE	LLWT	COP	WPD PSI		FT	TC	kW	HE	LLWT	COP		WPD PSI	FT	TC	kW	HE	LLWT		COP	GPM	PSI	FT				
30	75	1.7	3.9	100	492.4	44.89	339.5	113.2	3.2	1.7	4.0	21.1	495.5	43.09	348.7	108.9	3.4	3.7	8.6	20.8	497.1	42.21	353.3	106.7	3.5	6.5	15.1	20.7					
				80	521.1	36.38	397.3	93.9	4.2	1.7	4.0	23.0	525.5	34.91	406.7	89.3	4.4	3.7	8.6	22.9	527.7	34.19	411.3	87.0	4.5	6.5	15.1	22.8					
				100	502.5	45.10	348.9	113.5	3.3	1.7	4.0	23.9	506.2	43.26	358.9	109.0	3.4	3.7	8.6	23.7	508.1	42.36	363.9	106.8	3.5	6.5	15.1	23.6					
				120	484.6	56.10	293.5	133.1	2.5	1.7	4.0	24.8	487.8	53.86	304.3	128.8	2.7	3.7	8.6	24.7	489.4	52.77	309.6	126.6	2.7	6.5	15.1	24.6					
	113	3.6	8.3	100	527.4	36.48	403.2	94.1	4.2	1.7	4.0	24.7	532.1	34.99	413.0	89.5	4.5	3.7	8.6	24.6	534.5	34.26	417.9	87.1	4.6	6.5	15.1	24.5					
				80	507.3	45.20	353.4	113.6	3.3	1.7	4.0	25.3	511.4	43.34	363.8	109.1	3.5	3.7	8.6	25.2	513.5	42.43	369.0	106.9	3.5	6.5	15.1	25.1					
				100	488.0	56.20	296.6	133.2	2.5	1.7	4.0	26.1	491.5	53.94	307.7	128.8	2.7	3.7	8.6	25.9	493.3	52.84	313.3	126.7	2.7	6.5	15.1	25.9					
				120	527.4	36.48	403.2	94.1	4.2	1.7	4.0	24.7	532.1	34.99	413.0	89.5	4.5	3.7	8.6	24.6	534.5	34.26	417.9	87.1	4.6	6.5	15.1	24.5					
	150	6.3	14.5	100	511.4	43.34	363.8	109.1	3.5	3.7	8.6	25.2	513.5	42.43	369.0	106.9	3.5	6.5	15.1	25.1	513.5	42.43	369.0	106.9	3.5	6.5	15.1	25.1					
				80	488.0	56.20	296.6	133.2	2.5	1.7	4.0	26.1	491.5	53.94	307.7	128.8	2.7	3.7	8.6	25.9	493.3	52.84	313.3	126.7	2.7	6.5	15.1	25.9					
				120	511.4	43.34	363.8	109.1	3.5	3.7	8.6	25.2	513.5	42.43	369.0	106.9	3.5	6.5	15.1	25.1	513.5	42.43	369.0	106.9	3.5	6.5	15.1	25.1					
				130	482.2	60.19	277.1	138.7	2.3	3.7	8.6	26.3	483.9	58.98	283.0	136.5	2.4	6.5	15.1	26.3	483.9	58.98	283.0	136.5	2.4	6.5	15.1	26.3					
40	75	1.7	3.9	60	610.3	30.59	506.2	76.2	5.8	1.7	4.0	26.6	591.0	35.70	469.6	90.5	4.9	3.7	8.6	27.6	593.9	34.88	475.1	87.9	5.0	6.5	15.1	27.5					
				80	585.5	37.38	458.3	95.6	4.6	1.7	4.0	27.9	569.0	40.19	418.5	110.2	3.8	3.7	8.6	29.0	571.5	43.16	424.6	107.7	3.9	6.5	15.1	28.8					
				100	564.0	46.30	406.3	115.2	3.6	1.7	4.0	29.3	546.4	55.04	358.8	129.8	2.9	3.7	8.6	30.5	548.7	53.79	365.5	127.4	3.0	6.5	15.1	30.3					
				120	541.7	57.62	345.4	134.6	2.8	1.7	4.0	30.9	534.9	61.46	325.4	139.7	2.6	3.7	8.6	31.4	537.3	60.08	332.6	137.3	2.6	6.5	15.1	31.2					
	113	3.6	8.3	60	633.4	30.91	528.3	76.8	6.0	1.7	4.0	30.7	610.9	35.93	488.6	90.9	5.0	3.7	8.6	31.4	614.3	35.09	494.9	88.2	5.1	6.5	15.1	31.3					
				80	604.1	37.67	475.9	96.2	4.7	1.7	4.0	31.6	584.5	44.41	433.3	110.5	3.9	3.7	8.6	32.4	587.6	43.35	440.0	107.9	4.0	6.5	15.1	32.3					
				100	578.4	46.58	419.8	115.6	3.6	1.7	4.0	32.6	557.6	55.26	369.4	130.0	3.0	3.7	8.6	33.5	560.5	53.97	376.6	127.6	3.0	6.5	15.1	33.4					
				120	552.0	57.88	354.8	134.9	2.8	1.7	4.0	33.7	544.1	61.66	334.0	139.8	2.6	3.7	8.6	34.1	547.0	60.29	341.7	137.4	2.7	6.5	15.1	34.0					
	150	6.3	14.5	60	644.6	31.07	538.9	77.1	6.1	1.7	4.0	32.9	620.4	36.05	497.7	91.1	5.0	3.7	8.6	33.4	624.2	35.20	504.4	88.3	5.2	6.5	15.1	33.3					
				80	613.1	37.81	484.4	96.4	4.8	1.7	4.0	33.6	592.0	44.51	440.4	110.6	3.9	3.7	8.6	34.2	595.3	43.44	447.4	108.0	4.0	6.5	15.1	34.1					
				100	585.4	46.71	426.3	115.7	3.7	1.7	4.0	34.4	563.1	55.36	374.5	130.1	3.0	3.7	8.6	35.1	566.1	54.06	382.0	127.6	3.1	6.5	15.1	35.0					
				120	556.9	58.01	359.3	135.1	2.8	1.7	4.0	35.3	548.5	61.76	338.0	139.9	2.6	3.7	8.6	35.5	551.6	60.35	346.0	137.5	2.7	6.5	15.1	35.4					
50	75	1.7	3.9	60	701.3	31.84	592.9	78.7	6.5	1.7	4.0	34.3	678.5	36.73	553.5	92.1	5.4	3.7	8.6	35.3	682.5	35.79	560.7	89.1	5.6	6.5	15.1	35.2					
				80	670.6	38.68	538.9	98.0	5.1	1.7	4.0	35.7	650.3	45.30	496.0	111.7	4.2	3.7	8.6	36.9	654.1	44.10	503.9	108.4	4.3	6.5	15.1	36.7					
				100	642.9	47.76	480.2	117.3	3.9	1.7	4.0	37.3	620.0	56.34	428.1	131.2	3.2	3.7	8.6	38.7	623.7	54.89	436.7	128.4	3.3	6.5	15.1	38.4					
				120	612.6	59.33	410.4	136.6	3.0	1.7	4.0	39.1	603.8	62.89	389.5	140.9	2.8	3.7	8.6	39.7	607.7	61.30	398.9	138.2	2.9	6.5	15.1	39.4					
	113	3.6	8.3	60	733.5	32.29	623.6	79.5	6.7	1.7	4.0	39.0	706.5	37.06	580.4	92.6	5.6	3.7	8.6	39.8	711.5	36.08	588.7	89.5	5.8	6.5	15.1	39.6					
				80	696.6	39.08	563.6	98.7	5.2	1.7	4.0	40.0	672.3	45.59	517.1	112.1	4.3	3.7	8.6	40.9	677.0	44.36	526.0	109.1	4.5	6.5	15.1	40.7					
				100	663.2	48.13	499.3	117.9	4.0	1.7	4.0	41.2	636.1	56.61	443.2	131.5	3.3	3.7	8.6	42.2	640.6	55.12	452.8	128.7	3.4	6.5	15.1	42.0					
				120	627.1	59.67	423.8	137.0	3.1	1.7	4.0	42.5	621.7	61.52	412.0	138.4	3.0	6.5	15.1	42.7	621.7	61.52	412.0	138.4	3.0	6.5	15.1	42.7					
	150	6.3	14.5	60	749.2	32.52	638.6	80.0	6.8	1.7	4.0	41.5	720.1	37.22	593.4	92.9	5.7	3.7	8.6	42.1	725.7	36.23	602.4	89.7	5.9	6.5	15.1	42.0					
				80	709.2	39.27	575.5	99.0	5.3	1.7	4.0	42.4	683.0	45.73	527.3	112.3	4.4	3.7	8.6	43.0	688.2	44.48	536.7	109.3	4.5	6.5	15.1	42.9					
				100	672.9	48.31	508.4	118.1	4.1	1.7	4.0	43.3	643.8	56.74	450.5	131.6	3.3	3.7	8.6	44.0	648.8	55.23	460.6	128.8	3.4	6.5	15.1	43.9					
				120	634.0	59.83	430.2	137.2	3.1	1.7	4.0	44.3	628.3	61.62	418.4	138.5	3.0	6.5	15.1	44.5	628.3	61.62	418.4	138.5	3.0	6.5	15.1	44.5					
60	75	1.7	3.9	60	799.7	33.22	686.7	81.3	7.1	1.7	4.0	41.8	773.9	37.85	645.1	93.8	6.0	3.7	8.6	42.9	779.4	36.78	654.2	90.4	6.2	6.5	15.1	42.6					
				80	763.0	40.09	626.6	100.5	5.6	1.7	4.0	43.4	739.4	46.46	581.2	113.3	4.7	3.7	8.6	44.6	744.7	45.09	591.2	110.0	4.8	6.5	15.1	44.3					
				100	728.9	49.30	561.0	119.7	4.3	1.7	4.0	45.1	701.0	57.64	504.6	132.7	3.6	3.7	8.6	46.6	706.4	55.97	515.8	129.6	3.7	6.5	15.1	46.3					
				120	690.0	61.07	481.9	138.7	3.3	1.7	4.0	47.2	685.5	62.46	472.7	139.3	3.2	6.5	15.1	47.4	685.5	62.46	472.7	139.3	3.2	6.5	15.1	47.4					
	113	3.6	8.3	60	843.7	33.85	728.5	82.5	7.3	1.7	4.0	47.1	857.9	32.11	748.6	75.3	7.8	3.7	8.6	46.7	819.8	37.20	693.2	91.0	6.5	6.5	15.1	47.7					
				80	798.7	40.64	660.4	101.5	5.8	1.7	4.0	48.3	812.6	38.31	682.2	94.5	6.2	3.7	8.6	47.9	776.9	45.44	622.2	110.5	5.0	6.5	15.1	49.0					
				100	756.9	49.80	587.3	120.4	4.5	1.7	4.0	49.6	770.1	46.86	610.5	113.9	4.8	3.7	8.6	49.2	730.3	56.27	538.6	129.9	3.8	6.5	15.1	50.5					
				120	709.9	61.51	500.3	139.3	3.4	1.7	4.0	51.1	723.5	58.00	525.9	133.1	3.7	3.7	8.6	50.7	705.2	62.74	491.4	139.6	3.3	6.5	15.1	51.3					
	150	6.3	14.5	60	865.3	34.17	749.1	83.1	7.4	1.7	4.0	50.1	881.4	32.40	771.1	75.7	8.0	3.7	8.6	49.8	839.7	37.41	712.4	91.3	6.6	6.5	15.1	50.5					
				80	816.1	40.91	676.8	101.9	5.8	1.7	4.0	51.0	831.7	38.54	700.5	94.9	6.3	3.7	8.6	50.7	792.7	45.61	637.3	110.7	5.1	6.5	15.1	51.5					
				100	770.4	50.05	599.9	120.8	4.5	1.7	4.0	52.0	785.1	47.05	624.9	114.1	4.9	3.7	8.6	51.7	741.8	56.41	549.6	130.1	3.9	6.5	15.1	52.7					
				120	719.5	61.73	509.1	139.5	3.4	1.7	4.0	53.2	734.4	58.16	536.2	133.3	3.7	3.7	8.6	52.9	714.7	62.87	500.4	139.7	3.3	6.5	15.1	53.3					
70	75	1.7	3.9	60	905.0	34.74	786.8	84.2	7.6	1.7	4.0	49.1																					

Antifreeze Correction Table

EWT	Antifreeze Type	Antifreeze %	Cooling			Heating		WPD
			Total Cap	Sensible Cap	Watts	Total Cap	Watts	
90	Water	0%	1	1	1	1	1	1
	Ethanol	5%	0.998	0.998	1.002	0.996	0.999	1.025
		10%	0.996	0.996	1.003	0.991	0.997	1.048
		15%	0.994	0.994	1.005	0.987	0.996	1.098
		20%	0.991	0.991	1.006	0.982	0.994	1.142
		25%	0.986	0.986	1.009	0.972	0.991	1.207
		30%	0.981	0.981	1.012	0.962	0.988	1.265
		35%	0.977	0.977	1.015	0.953	0.985	1.312
		40%	0.972	0.972	1.018	0.943	0.982	1.37
		45%	0.966	0.966	1.023	0.931	0.978	1.431
	50%	0.959	0.959	1.027	0.918	0.974	1.494	
	Ethylene Glycol	5%	0.998	0.998	1.002	0.996	0.999	1.021
		10%	0.996	0.996	1.003	0.991	0.997	1.04
		15%	0.994	0.994	1.004	0.987	0.996	1.079
		20%	0.991	0.991	1.005	0.982	0.995	1.114
		25%	0.988	0.988	1.008	0.976	0.993	1.146
		30%	0.985	0.985	1.01	0.969	0.99	1.175
		35%	0.982	0.982	1.012	0.963	0.988	1.208
		40%	0.979	0.979	1.014	0.956	0.986	1.243
		45%	0.976	0.976	1.016	0.95	0.984	1.278
	50%	0.972	0.972	1.018	0.943	0.982	1.314	
	Methanol	5%	0.997	0.997	1.002	0.993	0.998	1.039
		10%	0.993	0.993	1.004	0.986	0.996	1.075
		15%	0.99	0.99	1.007	0.979	0.994	1.116
		20%	0.986	0.986	1.009	0.972	0.991	1.154
		25%	0.982	0.982	1.012	0.964	0.989	1.189
		30%	0.978	0.978	1.014	0.955	0.986	1.221
		35%	0.974	0.974	1.017	0.947	0.984	1.267
		40%	0.97	0.97	1.02	0.939	0.981	1.31
		45%	0.966	0.966	1.023	0.93	0.978	1.353
	50%	0.961	0.961	1.026	0.92	0.975	1.398	
	Propylene Glycol	5%	0.995	0.995	1.003	0.99	0.997	1.065
		10%	0.99	0.99	1.006	0.98	0.994	1.119
		15%	0.986	0.986	1.009	0.971	0.991	1.152
		20%	0.981	0.981	1.012	0.962	0.988	1.182
		25%	0.978	0.978	1.014	0.956	0.986	1.227
		30%	0.975	0.975	1.016	0.95	0.984	1.267
		35%	0.972	0.972	1.018	0.944	0.982	1.312
		40%	0.969	0.969	1.02	0.938	0.98	1.356
		45%	0.965	0.965	1.023	0.929	0.977	1.402
	50%	0.96	0.96	1.026	0.919	0.974	1.45	

Table Continued on Next Page

Antifreeze Correction Table

Table Continued from Previous Page

EWT	Antifreeze Type	Antifreeze %	Cooling			Heating		WPD
			Total Cap	Sensible Cap	Watts	Total Cap	Watts	
30	Water	0%	1	1	1	1	1	1
	Ethanol	5%	0.991	0.991	1.006	0.981	0.994	1.14
		10%	0.981	0.981	1.012	0.961	0.988	1.242
		15%	0.973	0.973	1.018	0.944	0.983	1.295
		20%	0.964	0.964	1.024	0.927	0.977	1.343
		25%	0.959	0.959	1.028	0.917	0.974	1.363
		30%	0.954	0.954	1.031	0.907	0.97	1.383
		35%	0.949	0.949	1.035	0.897	0.967	1.468
		40%	0.944	0.944	1.038	0.887	0.964	1.523
		45%	0.94	0.94	1.041	0.88	0.962	1.58
		50%	0.936	0.936	1.043	0.872	0.959	1.639
	Ethylene Glycol	5%	0.997	0.997	1.002	0.993	0.998	1.04
		10%	0.993	0.993	1.004	0.986	0.996	1.075
		15%	0.99	0.99	1.006	0.98	0.994	1.122
		20%	0.987	0.987	1.008	0.973	0.992	1.163
		25%	0.983	0.983	1.011	0.966	0.99	1.195
		30%	0.979	0.979	1.013	0.958	0.987	1.225
		35%	0.976	0.976	1.016	0.951	0.985	1.279
		40%	0.972	0.972	1.018	0.943	0.982	1.324
		45%	0.969	0.969	1.021	0.937	0.98	1.371
		50%	0.966	0.966	1.023	0.93	0.978	1.419
	Methanol	5%	0.995	0.995	1.004	0.989	0.997	1.069
		10%	0.989	0.989	1.007	0.978	0.993	1.127
		15%	0.984	0.984	1.011	0.968	0.99	1.164
		20%	0.979	0.979	1.014	0.957	0.986	1.197
		25%	0.975	0.975	1.017	0.949	0.984	1.216
		30%	0.971	0.971	1.019	0.941	0.981	1.235
		35%	0.967	0.967	1.022	0.933	0.979	1.286
		40%	0.963	0.963	1.025	0.924	0.976	1.323
		45%	0.959	0.959	1.028	0.917	0.974	1.36
		50%	0.955	0.955	1.03	0.91	0.971	1.399
	Propylene Glycol	5%	0.995	0.995	1.004	0.989	0.997	1.071
		10%	0.989	0.989	1.007	0.978	0.993	1.13
		15%	0.985	0.985	1.01	0.968	0.99	1.206
		20%	0.98	0.98	1.013	0.958	0.987	1.27
		25%	0.974	0.974	1.017	0.947	0.983	1.359
		30%	0.968	0.968	1.021	0.935	0.979	1.433
		35%	0.963	0.963	1.025	0.924	0.976	1.522
		40%	0.957	0.957	1.029	0.913	0.972	1.614
		45%	0.949	0.949	1.034	0.898	0.967	1.712
		50%	0.941	0.941	1.039	0.882	0.962	1.816

Physical & Electrical Data

Physical Data

Model	TMW360	TMW600	TMW840
Compressor (qty)	Scroll (2)	Scroll (2)	Scroll (2)
Compressor Oil Type	POE	PVE	PVE
Factory Charge HFC-410A (lbs) [kg] / circuit	15 [6.8]	27.5 [12.5]	33.8 [15.4]
Indoor / Load Water connection sizes FPT (in)	2	2-1/2	2-1/2
Outdoor / Source Water connection size FPT (in)	2	2-1/2	2-1/2
Weight - Operating (lbs) [kg]	1400 [635]	2055 [932]	2305 [1042]
Weight - Shipping (lbs) [kg]	1325 [601]	1925 [873]	2175 [983]
Water Volume (Source)			
Gallons [Liters]	4.7 [17.8]	8.3 [31.4]	9.5 [36]
Water Volume (Load)			
Gallons [Liters]	4.4 [16.7]	7.3 [27.6]	8.5 [32.2]

Unit Maximum Water Working Pressure	
Options	Max Working Pressure PSIG [kPa]
Base Unit	300 [2,068]
Motorized Valves	300 [2,068]

TMW Electrical Data

Model	Voltage Code	Voltage	Voltage Min/Max	Compressor			Total Unit FLA	Min Circuit Amps	Max UL/CSA HACR
				Qty	RLA (EA)	LRA (EA)			
TMW360	H	208-230/60/3	187/254	2	56.4	425	113	127	175
	F	460/60/3	414/506	2	25.5	173	51	57	80
	N	575/60/3	518/633	2	20.4	128	41	46	60
TMW600	F	460/60/3	414/506	2	42.8	272	86	96	125
	N	575/60/3	518/633	2	34.3	238	69	77	110
TMW840	F	460/60/3	414/506	2	56.2	310	112	126	175
	N	575/60/3	518/633	2	45.0	239	90	101	125

HACR circuit breaker in the US and Canada only

TMW Corner Weights (control box is on front) lbs [kg]

Model	Left Front	Left Rear	Right Front	Right Rear
TMW360	345 [156]	350 [159]	275 [125]	355 [161]
TMW600	492 [223]	500 [227]	400 [181]	533 [242]
TMW840	557 [252]	565 [255]	452 [204]	601 [271]

Dimensional Data – TMW360-840

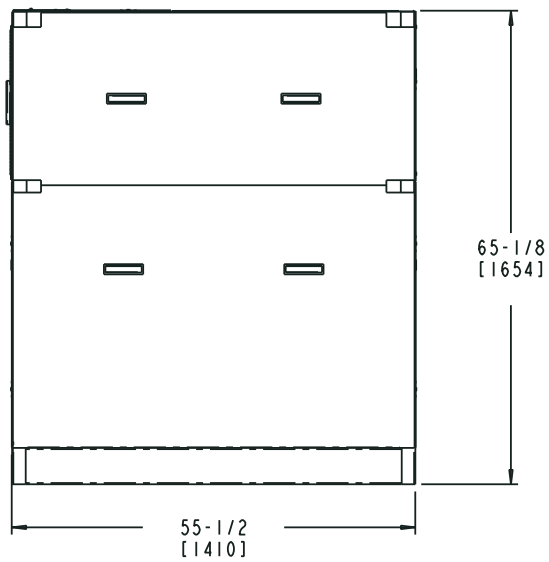
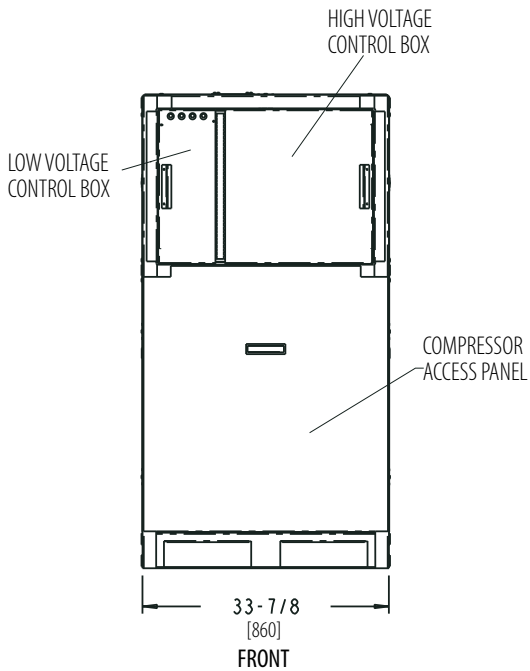
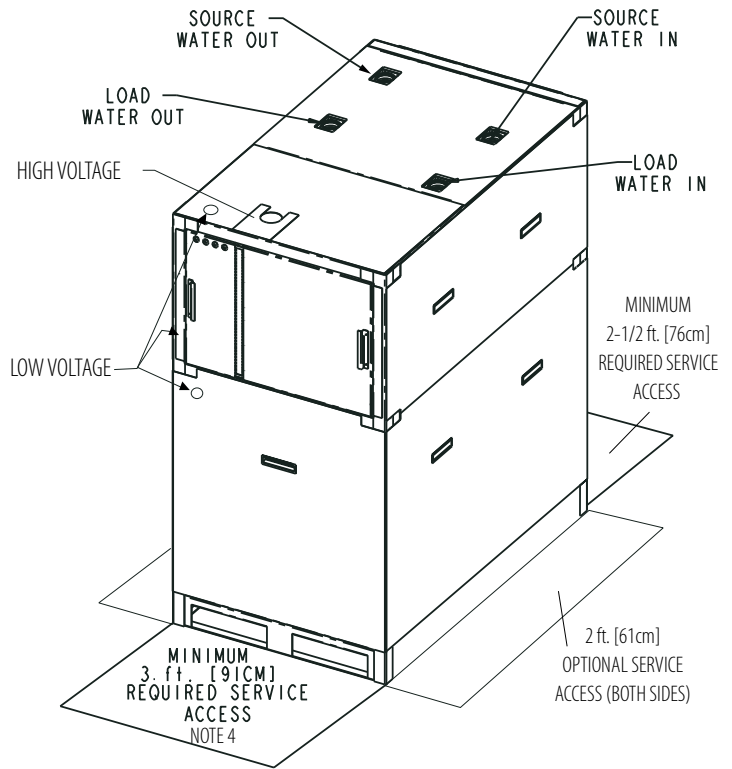
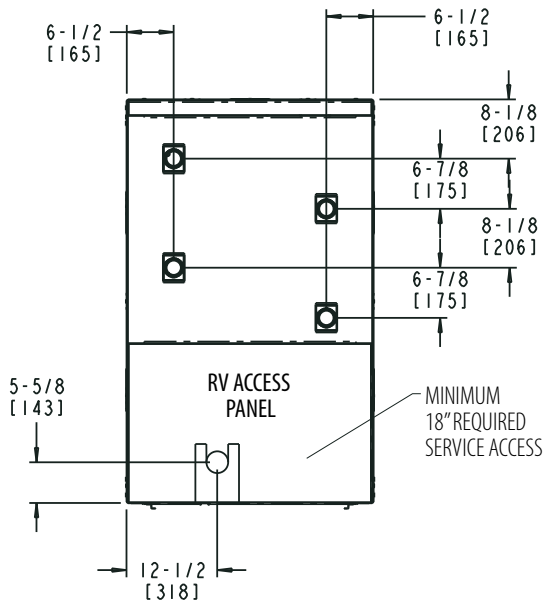

NOTE:

1. DIMENSIONS SHOWN IN INCHES AND [MILLIMETERS].
2. TMW360 WATER CONNECTIONS ARE 2" FPT.
3. TMW600 AND 840 WATER CONNECTIONS ARE 2.5" FPT.
4. FOR MULTIPLE UNITS PLACED SIDE BY SIDE. ALLOW SUFFICIENT SPACE FRONT OR BACK TO REMOVE UNIT.

TMW Large Series – Wiring Diagram Matrix and Sound Power Data

All current diagrams can be located online at climatemaster.com. Click 'Commercial Professional'.

1. Click 'Products' in the main navigation
2. Select 'Water-to-Water Series'
3. Select the TMW Large product series
4. Click the Wire Diagrams tab in the middle of the page
5. Select your voltage and controls

Model	Refrigerant	Wiring Diagram Part Number	Electrical	Agency
360-840	EarthPure® HFC-410A	96B152N09	208-230/60/3 460/60/3 575/60/3	UL

Sound Power Data

Model	dBA
TMW360	67
TMW600	70
TMW800	72

TMW Large Series – Typical Wiring Diagram, Cont'd.

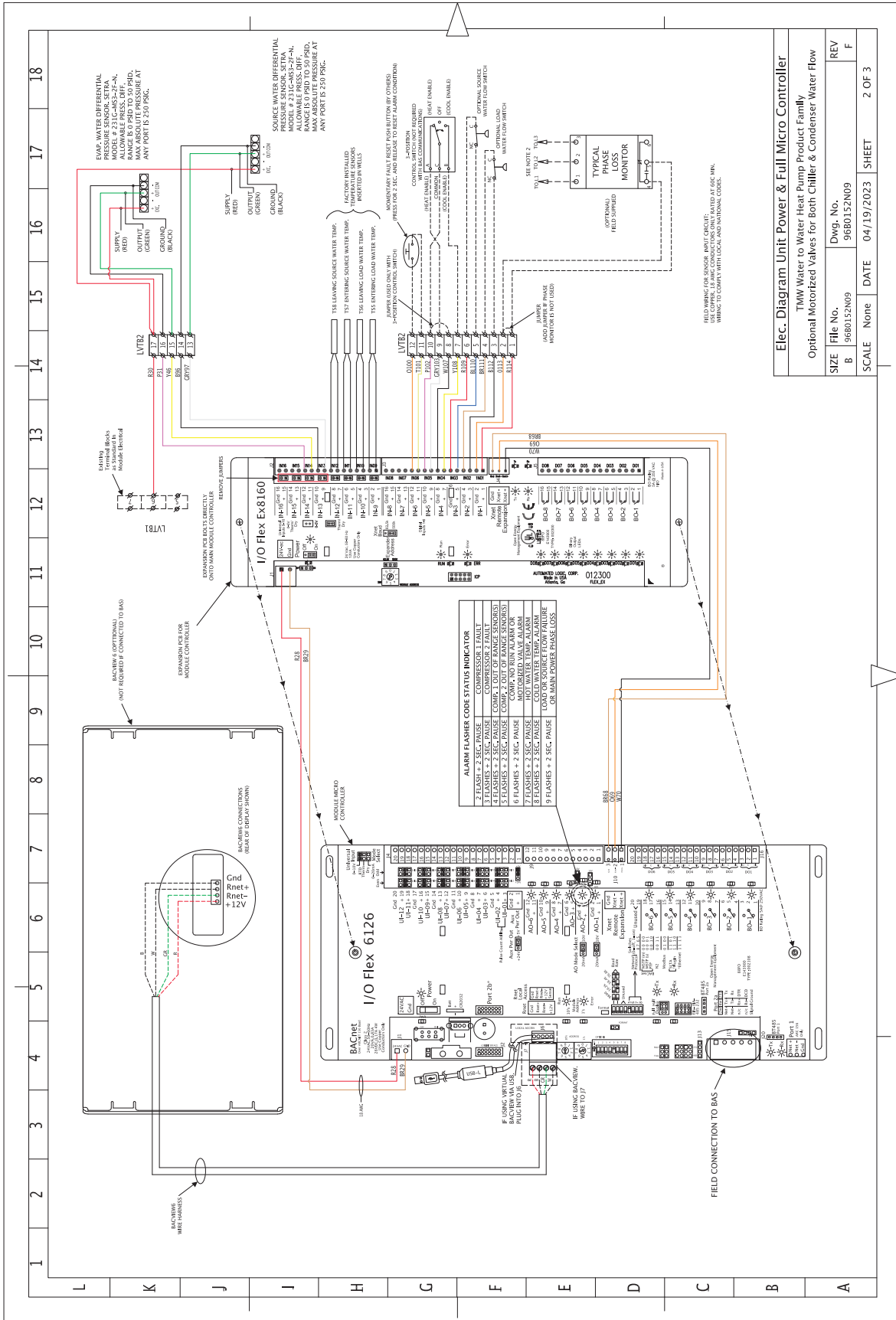

Elec. Diagram Unit Power & Full Micro Controller			
TMW Water to Water Heat Pump Product Family			
Optional Motorized Valves for Both Chiller & Condenser Water Flow			
SIZE	File No.	Dwg. No.	REV
B	9680152N09	9680152N09	F
SCALE	Note	DATE	SHEET
		04/19/2023	2 OF 3

ClimateMaster works continually to improve its products. As a result, the design and specifications of each product at the time of order may be changed without notice and may not be as described herein. Please contact ClimateMaster's Customer Service Department at 1-405-745-6000 for specific information on the current design and specifications. Statements and other information contained herein are not express warranties and do not form the basis of any bargain between the parties, but are merely ClimateMaster's opinion or commendation of its products. The latest version of this document is available at climatemaster.com. © ClimateMaster, Inc. All rights reserved 2011

TMW Large Series – Typical Wiring Diagram, Cont'd.

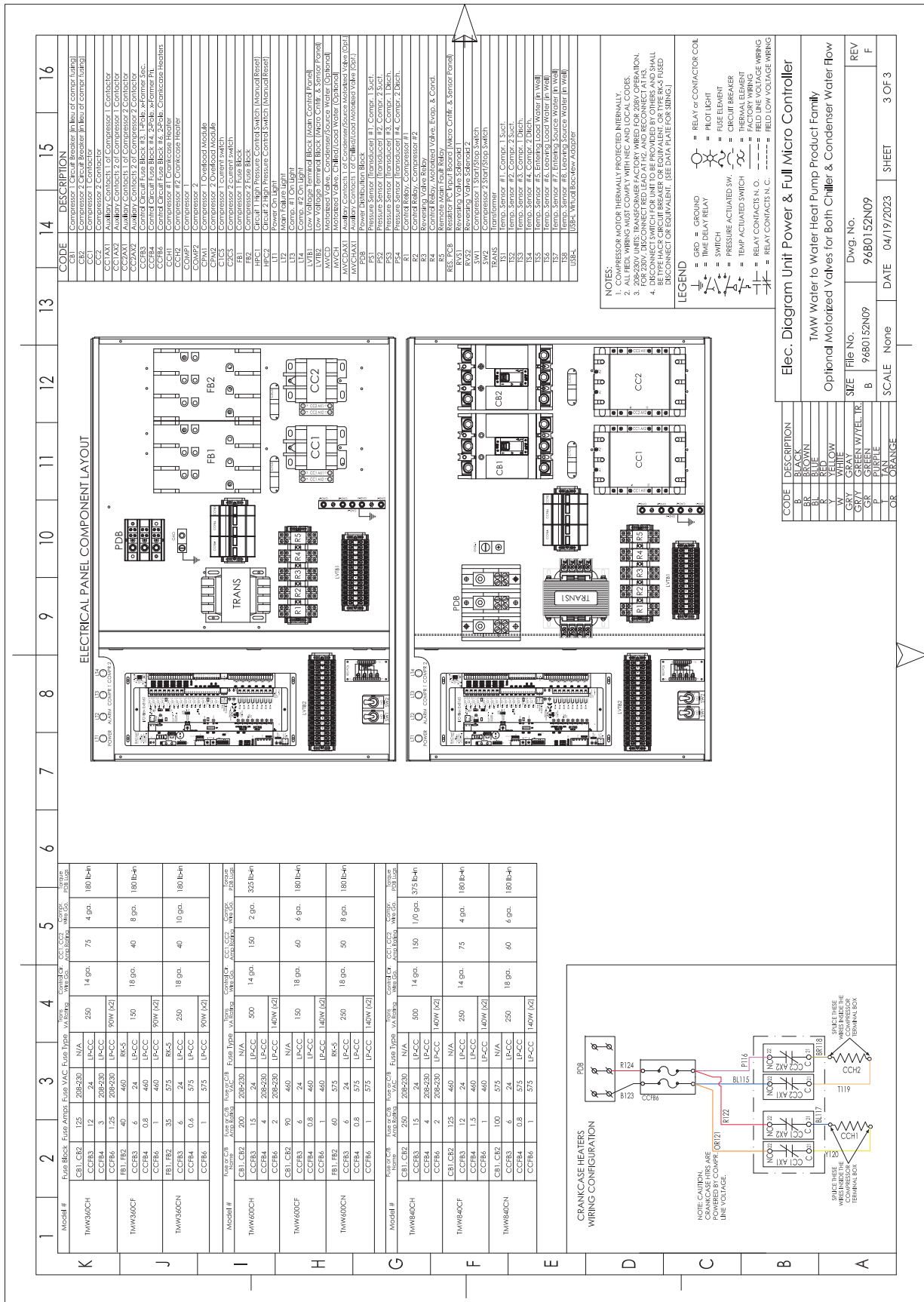

ClimateMaster works continually to improve its products. As a result, the design and specifications of each product at the time of order may be changed without notice and may not be as described herein. Please contact ClimateMaster's Customer Service Department at 1-405-745-6000 for specific information on the current design and specifications. Statements and other information contained herein are not express warranties and do not form the basis of any bargain between the parties, but are merely ClimateMaster's opinion or commendation of its products. The latest version of this document is available at climatemaster.com. © ClimateMaster, Inc. All rights reserved 2011

Tranquility® Large Water-to-Water (TMW360 - 840) Series 60Hz Engineering Specifications – Page 1

General:

Furnish and install ClimateMaster “TMW” Water-Source Heat Pumps as indicated on the plans. Equipment shall be completely assembled, piped and internally wired. Capacities and characteristics are as listed in the schedule and the specifications that follow.

Units shall be supplied completely factory built capable of operating over an entering water temperature range from 30° to 120°F (-1.1° to 48.9°C) as standard. Equivalent units from other manufacturers may be proposed provided approval to bid is given 10 days prior to bid closing. All equipment listed in this section must be rated in accordance with Air-Conditioning, Heating and Refrigeration Institute/International Standards Organization (AHRI/ISO 13256-2). The units shall be certified to UL508A Standard. The units shall have a UL-US-C label.

All units shall pass a factory acceptance test. The quality control system shall automatically perform factory acceptance test via computer. A detailed report card from the factory acceptance test shall ship with each unit. **(Note: If unit fails the factory acceptance test, it shall not be allowed to ship. Unit serial number shall be recorded by factory acceptance test and furnished on report card for ease of unit warranty status.)**

Units are stand alone and will operate on default settings, or reprogrammed settings using the BACview 6A controller, or Building Automated System (BAS). Multiple units can be installed on common loop. Staging of units is accomplished by temperature offsets and compressor PID settings between the units.

Basic Construction:

All units must have multiple removable panels for serviceability of compressor compartment. **Units having only one access panel shall not be acceptable.** Service panels shall have Allen head three-quarter turn quick release latches, and hand hold pockets for easy removal.

The heat pumps shall be fabricated from heavy gauge galvanized steel with powder coat paint finish. Both sides of the steel shall be painted for added protection. All interior surfaces shall be lined with 1/2 inch (12.7 mm) thick, 1-1/2 lb/ft³ (24 kg/m³) acoustic type glass fiber insulation.

Standard cabinet panel insulation must meet NFPA 90A requirements, air erosion and mold growth limits of UL-181, stringent fungal resistance test per ASTM-C1071 and ASTM G21, and shall meet zero level bacteria growth per ASTM G22. **Unit insulation must meet these stringent requirements or unit(s) will not be acceptable.**

The frame design shall consist of heavy gauge galvanized steel with powder coat finish. The module must have a low center of gravity base with cutouts for forklift or pallet jack and the frame must be designed to fit through a standard 36 inch doorway.

Cabinets shall have separate holes and knockouts for entrance of line voltage and low voltage control wiring. All factory-installed wiring passing through factory knockouts and openings shall be protected from sheet metal edges at openings by plastic ferrules. Supply and return water connections shall be copper FPT fittings. **Contractor shall be responsible for any extra costs involved in the installation of units that do not have this feature.** Contractor must ensure that units can be easily removed for servicing and coordinate locations of electrical conduit and lights with the electrical contractor.

Unit(s) shall have exterior indicator lights showing, 1) power (on-Green), 2) unit “fault” status (fault - Red), 3) compressor 1 operation (on-Green), and 4) compressor 2 operation (on-Green). **Contractor shall be responsible for providing control circuitry and indicator lights for units not providing this feature.**

Tranquility® Large Water-to-Water (TMW360 - 840) Series 60Hz Engineering Specifications – Page 2

Refrigerant Circuit:

Units shall have sealed, isolated refrigerant circuits, each including a high efficiency scroll compressor designed for heat pump operation, a thermostatic expansion valve for refrigerant metering, a reversing valve, sight glass, filter dryer, load and source brazed plate refrigerant to water heat exchangers, and safety controls including a high pressure switch, low pressure switch (loss of charge), and low water temperature sensors. Access fittings shall be factory installed on high and low pressure refrigerant lines to facilitate field service. Activation of any safety device shall prevent compressor operation via a microprocessor lockout circuit.

Hermetic compressors shall be internally sprung. The compressors will be mounted on specially engineered sound-tested EPDM vibration isolation grommets to a large heavy gauge base plate. Compressors shall have thermal overload protection. Each compressor shall have isolation switch to aid start-up and service. **Units without isolation switch are not acceptable.**

Heat exchangers shall be highly efficient, refrigerant to water, dual circuited, brazed plate design, constructed of 316 stainless steel; designed, tested, and UL stamped in accordance with ASME Section VIII pressure vessel code for 650 PSIG (4482 kPa) working refrigerant pressure. The heat exchangers shall be mounted to eliminate the effect of migration of refrigerant to the cold evaporator with consequent liquid slugging on start-up. The heat exchangers shall be mounted on two layers of noise attenuating rubber isolation pads which also acts as a thermal barrier. The heat exchangers shall be wrapped with 3/4 inch closed cell insulated blanket and closed cell insulation shall be provided on suction side refrigerant tubing to prevent condensation.

Water Circuit:

Unit shall have all internal water tubing insulated with closed cell insulation. Field connections shall be on the top so multiple units can be installed side by side. PT ports and heat exchanger flushing connections shall be accessible from back service panel. Load and Source water shall be tested and results approved by ClimateMaster to activate unit warranty.

Unit shall have Pressure Differential Sensors for Load and Source factory installed. Sensors are for proof of water flow.

External of unit contractor must supply the following: minimum 60 mesh stainless steel screen strainers (for Load and Source), and pressure taps. All components should be isolated for ease of service.

Option: Load Side Motorized Valve

Option: Unit shall have Source Motorized Valve to prevent unit from locking out when water temperature is below 60°F in cooling mode. Valve will automatically modulate to maintain compressor head pressure, for continuous unit operation.

Electrical:

The control box shall consist of a NEMA Type I enclosure with high and low voltage compartments, components include: low voltage connection block, power distribution block, compressor fusing, contactors, finger safe control fusing, transformer, isolation relays, status and alarm relay, 16-bit microprocessor DDC controller with built in native Building Automation System (BAS) communication protocols (BACnet) two isolation switches to disable each individual compressor during start-up or troubleshooting, and external status indicating lights.

Solid State Control System:

DDC Controller shall be specifically designed to protect against building electrical system noise contamination, EMI and RFI interference. DDC control system shall be fully compatible with the Building Automation System via native BACnet or BACview 6. Scheduling of the various compressors shall be performed by the microprocessor based controller. Controller shall provide following compressor safety

Tranquility® Large Water-to-Water (TMW360 - 840) Series 60Hz Engineering Specifications – Page 3

protections: anti-short cycling, high voltage, low voltage, high discharge pressure, low suction pressure, high discharge temperature, low suction temperature, high source leaving water temperature, low load leaving water temperature, load low water flow, and source low water flow.

Units not providing the 11 safety protections of anti-short cycling, high voltage, low voltage, high discharge pressure, low suction pressure, high discharge temperature, low suction temperature, high source leaving water temperature, low load leaving water temperature, load loss of water flow, and source loss of water flow will not be accepted. A compressor run time equalization sequence is provided to ensure even distribution of compressor run time. **Units without even distribution of compressor run time are not acceptable.** A load limit control shall be available to limit the number of compressors that can be energized at one time.

DDC Controller shall monitor and report the following for each refrigeration circuit:

- a. Discharge pressure and temperature faults.
- b. Suction pressure and temperature faults.
- c. Compressor winding high temperature fault.
- d. Low Load leaving chilled water temperature fault.
- e. High source leaving water temperature fault.

DDC Controller shall monitor and report the following system parameters for the unit:

- f. Chilled water entering and leaving temperature.
- g. Condenser water entering and leaving temperature.
- h. Load and Source low water flow.
- i. Communication error.
- j. Electrical voltage/phase failure.

Any failure condition shall cause a "fault" indication at the DDC Controller and shutdown of that compressor circuit. In the case of a system "fault" the entire unit will shutdown. When any fault occurs, the DDC Controller shall record conditions at the time of the fault, and store the data for recall. This information shall be capable of recall through BACview6 and displayed on the 4 line by 40 character, back-lit LCD. A history of faults shall be maintained including date and time for each fault (up to the last 100 occurrences). Internal leaving chilled water reset control will ensure that the parallel evaporators are operated above the freeze point for part load operation.

DDC Controller shall have flashing Light Emitting Diode (LED) for the following: compressor 1 fault, compressor 2 fault, sensors for compressor 1 out of range, sensors for compressor 2 out of range, compressor alarm, motorized water valve alarm, hot water temperature alarm, cold water temperature alarm, load flow failure, source flow failure, and main power phase loss. **Units without flashing LED for unit fault are not acceptable.**

BACview 6 with cable must be used for setting controller at start up. BACview 6 can also be used to operate, monitor, and change default settings, or as a service tool for the unit.

Warranty:

ClimateMaster shall warranty equipment for a period of 12 months from start up or 18 months from shipping (which ever occurs first).

Option: Extended 4-year compressor warranty covers compressor for a total of 5 years.

Option: Extended 4-year refrigeration circuit warranty covers heat exchangers, reversing valve, expansion valve and compressor for a total of 5 years.

Tranquility® Large Water-to-Water (TMW360 - 840) Series 60Hz Engineering Specifications – Page 4

Option: Extended 4-year control board warranty covers the control board for a total of 5 years.

FIELD OPTIONS/ACCESSORIES

Hose Kits:

All units shall be connected with hoses. The hoses shall be 2 feet (61 cm) long, braided stainless steel; fire rated hoses complete with adapters. Only fire rated hoses will be accepted.

Valves:

The following valves are available and will be shipped loose: for field installation.

- a. Ball valve; bronze material, standard port full flow design, FPT connections.
- b. Ball valve with memory stop and PT port.

Strainers:

The following strainers are field obtained and installed.

- a. 3 inch FPT Y-strainer. 60 mesh screen.
- b. 3 inch FPT Basket strainer. 60 mesh screen.

BACview6: (Required for start up)

Used to control the unit if BAS is not used or as a service tool for service diagnostics at the unit. DDC Controller has port for cable.

3 way switch: (Not required if connected to BAS) field obtained and installed operation mode switch selects - off, cool, heat.

Phase monitor: (Not required but recommended) field obtained and installed. Protects compressors.

NOTICE! This product specification document is furnished as a means to copy and paste ClimateMaster product information into project specification. It is not intended to be a complete list of product requirements. This document is an excerpt from the product submittal and must not be used without consulting the complete product submittal. For complete product installation and application requirements, please consult the complete product submittal. ClimateMaster is not responsible for misuse of this document or a failure to adequately review specific requirements in the product submittal.

Performance Sheet

SUBMITTAL DATA - I-P UNITS

Unit Designation: _____

Job Name: _____

Architect: _____

Engineer: _____

Contractor: _____

PERFORMANCE DATA

Cooling Capacity: _____ Btuh

EER: _____

Heating Capacity: _____ Btuh

COP: _____

Ambient Air Temp: _____ °F

Source Entering Water Temp (Clg): _____ °F

Source Leaving Water Temp (Clg): _____ °F

Load Entering Water Temp (Clg): _____ °F

Load Leaving Water Temp (Clg): _____ °F

Source Entering Water Temp (Htg): _____ °F

Source Leaving Water Temp (Htg): _____ °F

Load Entering Water Temp (Htg): _____ °F

Load Leaving Water Temp (Htg): _____ °F

Operating Weight: _____ (lb)

ELECTRICAL DATA

Power Supply: _____ Volts

_____ Phase _____ Hz

Minimum Circuit Ampacity: _____

Maximum Overcurrent Protection: _____

SUBMITTAL DATA - S-I UNITS

Unit Designation: _____

Job Name: _____

Architect: _____

Engineer: _____

Contractor: _____

PERFORMANCE DATA

Cooling Capacity: _____ kW

EER: _____

Heating Capacity: _____ kW

COP: _____

Ambient Air Temp: _____ °C

Source Entering Water Temp (Clg): _____ °C

Source Leaving Water Temp (Clg): _____ °C

Load Entering Water Temp (Clg): _____ °C

Load Leaving Water Temp (Clg): _____ °C

Source Entering Water Temp (Htg): _____ °C

Source Leaving Water Temp (Htg): _____ °C

Load Entering Water Temp (Htg): _____ °C

Load Leaving Water Temp (Htg): _____ °C

Operating Weight: _____ (kg)

ELECTRICAL DATA

Power Supply: _____ Volts

_____ Phase _____ Hz

Minimum Circuit Ampacity: _____

Maximum Overcurrent Protection: _____

ClimateMaster works continually to improve its products. As a result, the design and specifications of each product at the time of order may be changed without notice and may not be as described herein. Please contact ClimateMaster's Customer Service Department at 1-405-745-6000 for specific information on the current design and specifications. Statements and other information contained herein are not express warranties and do not form the basis of any bargain between the parties, but are merely ClimateMaster's opinion or commendation of its products. The latest version of this document is available at climatemaster.com. © ClimateMaster, Inc. All rights reserved 2011

Revision History

Date:	Item:	Action:
05/11/23	Pages 3, 4, 5, 18	Updated format for consistency with other documents
05/05/23	Pages 3, 23	Removed Modbus and N2 options
04/21/22	Page 23	Updated source motorized valve specification text to identify the component as optional
10/05/21	All	Removed LON Controls
04/30/21	Page 13	Added Clarity to the grey shaded areas of the TMW840 in Heating mode that require antifreeze solution
01/13/21	Pages 23, 25	Updated Water Circuit and BACView 6 sections of Engineering Specs
7/28/20	pg. 16	"H" voltage option for sizes 600 & 840 - Removed
7/16/20	Pages 3, 6, 23	Updated Unit Features, Added Option B to Digit 13 on Decoder, Updated Engineering Specs
7/15/20	Pages. 16, 24, 26	Updated Physical data, note on Electrical Data, updated warranty section of Engineering Specs, updated Performance Sheet
5/27/20	Various Pages	Removed options B and S from digit 13
9/16/19	Pages 7, 16, 18-21	Update Revision B to C
11/15/16	Updated Document Design	Updated
6/14/16	Pages 4, 22, 24	Added additional buffer tank information and BACview6 needed for start up.
03/31/16	Pages 8 and 22	Edit performance data wording and run test engineering specs
03/05/15	Performance Data Text - Pages 1-2	Updated
02/27/13	Heating Performance Data	Updated
12/17/12	All Pages	Added Size 840
11/14/11	Dimensional Data	Updated
08/09/11	Unit Maximum Working Water Pressure	Updated to Reflect New Safeties
04/29/11	Physical Data Table, Performance Data Tables	Updated
02/08/11	Created	



A NIBE GROUP MEMBER

7300 S.W. 44th Street
 Oklahoma City, OK 73179
 Phone: 405-745-6000
 climatemaster.com