

Tranquility® (TRE) Rooftop Series

Submittal Data

Models TRE036 - 240 60Hz - HFC-410A



LC410 LC410

Rev.: February 28, 2023



ClimateMaster works continually to improve its products. As a result, the design and specifications of each product at the time of order may be changed without notice and may not be as described herein. Please contact ClimateMaster's Customer Service Department at 1-405-745-6000 for specific information on the current design and specifications. Statements and other information contained herein are not express warranties and do not form the basis of any bargain between the parties, but are merely ClimateMaster's opinion or commendation of its products. The latest version of this document is available at climatemaster.com. © ClimateMaster, Inc. All rights reserved 2010

Table of Contents

TRE Rooftop Series

	Introduction	4
	Features, Options and Accessories	5
iGate® 2 Communicating Controls Powered by DXM2.5		6
iGate® 2 Communicating (AWC) Thermostat		7
myUplink – Web and Mobile Interface		8
	Selection Procedure	9
	TRE Series Nomenclature	11
Performance Data – AHRI/ASHRAE/ISO 13256-1		13
	Performance Data – Selection Notes	14
	Performance Data – TRE036	15
	Performance Data – TRE048	16
	Performance Data – TRE060	17
	Performance Data – TRE072	18
	Performance Data – TRE096	19
	Performance Data – TRE120	20
	Performance Data – TRE144	21
	Performance Data – TRE168	22
	Performance Data – TRE240	23
	Antifreeze Correction Table	24
Correction Table – Additional Water Pressure Drop		26
	Blower Performance Data – TRE036	27
	Blower Performance Data – TRE048	28
	Blower Performance Data – TRE060	29
	Blower Performance Data – TRE072	30
	Blower Performance Data – TRE096	31
	Blower Performance Data – TRE120	33
	Blower Performance Data – TRE144	35
	Blower Performance Data – TRE168	37
	Blower Performance Data – TRE240	39
	Performance Data – Correction Tables	41
	Physical Data	42
TRE Series Nomenclature – ClimaDry® II Option		43
ClimaDry® II Option – Benefits and Application		44
ClimaDry® II – Sequence of Operation		46
TRE036 - 72 Dimensional Data		48



Document page number is shown next to part number (e.g. LC410 - 3 = page 3). Since not all pages are typically used in the submittals process, the page number in the lower right corner can still be used (page ____ of ____).

ClimateMaster works continually to improve its products. As a result, the design and specifications of each product at the time of order may be changed without notice and may not be as described herein. Please contact ClimateMaster's Customer Service Department at 1-405-745-6000 for specific information on the current design and specifications. Statements and other information contained herein are not express warranties and do not form the basis of any bargain between the parties, but are merely ClimateMaster's opinion or commendation of its products. The latest version of this document is available at climatemaster.com. © ClimateMaster, Inc. All rights reserved 2010

TRE Rooftop Series

TRE096 - 144 Dimensional Data	49
TRE168 - 240 Dimensional Data	50
Standard Roof Curb	51
TRE Electrical Data	52
TRE Electrical Data - ClimaDry® II or Internal Secondary Pump	53
TRE Wiring Diagram Matrix	54
Engineering Specifications	55
Performance Sheet	64
Revision History	66



THE TRANQUILITY® (TRE) ROOFTOP SERIES

The Tranquility® TRE Rooftop Series offers a high efficiency product for applications where outdoor equipment is required. Not only does the Tranquility TRE exceed ASHRAE 90.1 efficiencies, but it also uses EarthPure® HFC-410A zero ozone depletion refrigerant, making it an extremely environmentally-friendly option. Tranquility TRE is eligible for LEED (Leadership in Energy and Environmental Design) points because of the “green” technology design. The Tranquility TRE is up to 40% more efficient than typical air source rooftop units.

ClimateMaster’s exclusive double isolation compressor mounting system makes the Tranquility TRE one of the quietest rooftop units on the market. Compressors are mounted on specially engineered sound-tested EPDM grommets to a heavy gauge mounting plate, which is further isolated from the cabinet base with rubber grommets for maximized vibration and sound attenuation. The easy access control box and large access panels make installing and maintaining the unit easier than other water-source heat pumps currently in production.

Available in sizes 3 tons (10.6 kW) through 20 tons (70.3 kW) with various outdoor air options, the Tranquility TRE offers a wide range of units for most any installation. The Tranquility TRE has an extended range refrigerant circuit, capable of ground loop (geothermal) applications as well as water loop (boiler-tower) applications. Standard features are many. Microprocessor controls, galvanized steel cabinet, polyester powder coat paint and TXV refrigerant metering device are just some of the features of the flexible Tranquility TRE. All units are equipped with scroll compressors and belt drive blowers.

The ability to handle outside air is one of the most attractive features of the Tranquility TRE. Choices include manual fresh air damper, motorized fresh air damper, modulating economizer with enthalpy controls. Options such as DDC controls, factory-installed water solenoid valves, and several filter choices allow customized design solutions.

iGate® 2 technology provides technicians an interface into the operation of the system in real time without the need for hard tooling. On board advanced controls communicate the key operating system temperatures allowing technicians to start-up, commission, and service the equipment remotely by smart phone or website via the cloud. Communication can also be done at the unit via a communicating thermostat or handheld service tool. Not only does iGate 2 monitor current performance, it also allows the functionality to make system adjustments and captures operating conditions at time of fault. All this information is displayed in an easy to read format maximizing the usability of the experience.

ClimateMaster’s patented ClimaDry® II Dehumidification option is an innovative means of providing modulating reheat without the complication of refrigeration controls. ClimaDry II is hot gas generated reheat, which utilizes one of the biggest advantages of a Water-Source Heat Pump (WSHP), the transfer of energy through the water piping system. ClimaDry II simply diverts condenser water through a water-to-air coil that is placed after the evaporator coil. ClimaDry II is the simplified leading reheat solution for commercial buildings

The Tranquility TRE Rooftop Series are designed to meet the challenges of today’s HVAC demands with a high efficiency, high value solution.

Features, Options and Accessories

FEATURES

- All sizes 036 (3 ton) through 240 (20 ton) exceed ASHRAE 90.1 efficiencies
- Copeland scroll compressor(s)
- Unique double isolation compressor mounting with vibration isolation for quiet operation
- Dual refrigeration circuits (sizes 96 and larger)
- Galvanized steel construction with polyester powder coat paint
- Stainless steel drain pan standard
- Double wall construction for access doors with stainless steel hardware
- TXV metering device
- iGate® 2 Communicating Controls Powered by CXM2
 - Multiple communication pathways,
 - o Cloud-based connectivity via iGate 2 Wi-Fi communicating color touch screen thermostat for remote monitoring, access, and diagnosis. Including the new functionality for contractors/building engineers to monitor and make mass changes on multi-unit systems
 - o Connect directly to the system with use of a handheld service tool
 - Provides real-time unit operating conditions
 - Reduces start-up, commissioning, and service time by removing the need for hard tooling to take temperature measurements
 - Captures operating conditions in the event of a safety shutdown
- Belt-drive blowers for flexible CFM/ESP operation
- Up to 2" ESP capability
- Slide-out blower assembly with high efficiency motors and variable pitch sheaves
- Unit Performance Sentinel performance monitoring system
- Eight safeties standard

OPTIONS

- iGate® 2 Communicating Controls Powered by DXM2.5
 - Includes all of the features listed above for CXM2 controls including cloud-based connectivity via iGate 2 WiFi communicating color touch screen thermostat for remote monitoring, access, and diagnosis
 - Controls ClimaDry® II hydronic modulating reheat
- Extended range insulation for geothermal applications
- BACnet, Modbus and Johnson N2 compatibility options for DDC controls
- ClimaDry® II modulating reheat
- Ability to implement demand controlled ventilation (DCV) with optional enthalpy economizer and optional CO₂ sensor.
- Two-way motorized water valves that prevent water flow through the unit when it is not in operation increasing system pumping efficiency
- Internally mounted water pump for single pipe systems

ACCESSORIES

- Wi-Fi communicating color touch screen thermostat
- Various length braided hose kits with optional water valves, PT plugs, blowdown valve, flow limiting, and strainer options
- Wide variety of thermostat options to meet your application needs
- Filters - 1" (Merv 8) or 2" (Merv 11 & 13)

iGate[®] 2 Communicating Controls Powered by CXM2

iGate[®] 2 Communication – Cloud connected, web-enabled information gateway to monitor, control, and diagnose your system

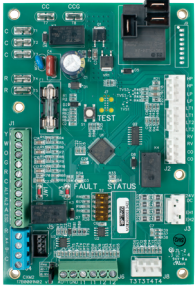

Tranquility[®] TRE Rooftop Series is equipped with industry-first, iGate[®] 2 communication information gateway that allows users to interact with their water-source system in easy to read clear language.

Monitor/Configure – Installers can configure from the myUplink PRO website, mobile app, iGate 2

Communicating (AWC) Thermostat, or diagnostic tool, including: Unit family, size, accessory configuration, and demand reduction (optional, to limit unit operation during peak times). Users can look up the current system status: temperature sensor readings and operational status of the blower.

Precise Control – The new CXM2 board enables intelligent, 2-way communication between the CXM2 board and smart components like the communicating thermostat and diagnostic tool. The advanced CXM2 board uses information received from the temperature sensors to precisely control operation to deliver high efficiency, reliability and increased comfort.

Diagnostics – iGate 2 takes diagnosing water source heat pump units to a next level of simplicity, by providing a dashboard of system and fault information, in clear language, on the AWC Communicating Thermostat, handheld service tool and the web portal/mobile app on the internet.

iGate 2 Thermostat Service Warnings notify the homeowner and contractor of a fault and displays fault descriptions by app notifications/email with possible causes. Additionally, the current system status can be viewed graphically on the web portal and mobile app.

In iGate 2 Service Mode, the service personnel can access fault description, possible causes and most importantly, the conditions (temp, flow, i/o conditions, configuration) at the time of the fault. Manual Operation mode allows the service personnel to manually command operation for any of the thermostat outputs, blower speed, to help troubleshoot specific components. This operation can either be conducted at the unit with a communicating thermostat/diagnostic tool or remotely with mobile app/website when the AWC Communicating Thermostat controls are used.

With an iGate 2 communicating system, users and contractors have a web-enabled gateway to system information never before available and exclusive to ClimateMaster products.

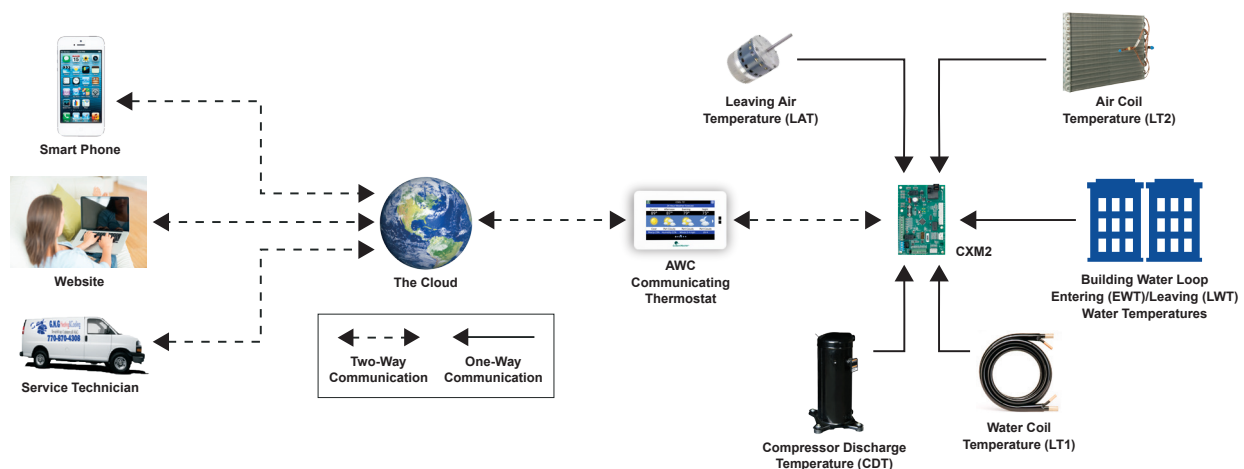

iGate® 2 Communicating Controls Powered by DXM2.5

iGate® 2 Communication – Cloud connected, web-enabled information gateway to monitor, control, and diagnose your system

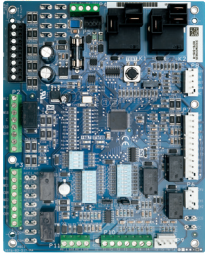

Tranquility® TRE Rooftop Series is equipped with industry-first, iGate® 2 communication information gateway that allows users to interact with their water-source system in easy to read clear language AND delivers improved reliability/efficiency by precisely controlling smart components.

Monitor/Configure – Installers can configure from the myUplink PRO website, mobile app, iGate 2 Communicating AWC Thermostat, or diagnostic tool, including: Airflow, unit family, size, accessory configuration, and demand reduction (optional, to limit unit operation during peak times). Users can look up the current system status: temperature sensor readings and operational status of the blower.

Precise Control – The new DXM2.5 board enables intelligent, 2-way communication between the DXM2.5 board and smart components like the communicating thermostat/diagnostic tool and constant volume (CV) EC fan motor. The advanced DXM2.5 board uses information received from the smart components and temperature sensors to precisely control operation of the variable speed CV EC fan motor to deliver higher efficiency, reliability and increased comfort.

Diagnostics – iGate 2 takes diagnosing water source heat pump units to a next level of simplicity, by providing a dashboard of system and fault information, in clear language, on the AWC Communicating Thermostat, handheld service tool and the web portal/mobile app on the internet.

iGate 2 Thermostat Service Warnings notify the homeowner and contractor of a fault and displays fault descriptions by app notifications/email with possible causes. Additionally, the current system status can be viewed graphically on the web portal and mobile app.

In iGate 2 Service Mode, the service personnel can access fault description, possible causes and most importantly, the conditions (temp, flow, i/o conditions, configuration) at the time of the fault. Manual Operation mode allows the service personnel to manually command operation for any of the thermostat outputs, blower speed, to help troubleshoot specific components. This operation can either be conducted at the unit with a communicating thermostat/diagnostic tool or remotely with mobile app/website when the AWC Communicating Thermostat controls are used.

With an iGate 2 communicating system, users and contractors have a web-enabled gateway to system information never before available and exclusive to ClimateMaster products.

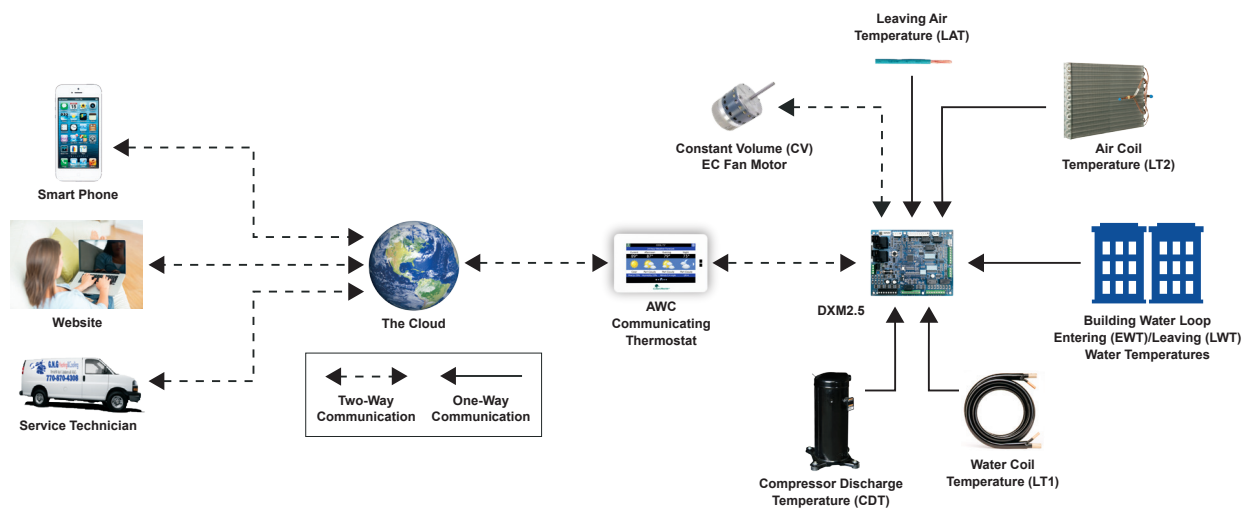

iGate® 2 Communicating (AWC) Thermostat

iGate® 2 Communication – Cloud connected, web-enabled information gateway to monitor, control, and diagnose your system

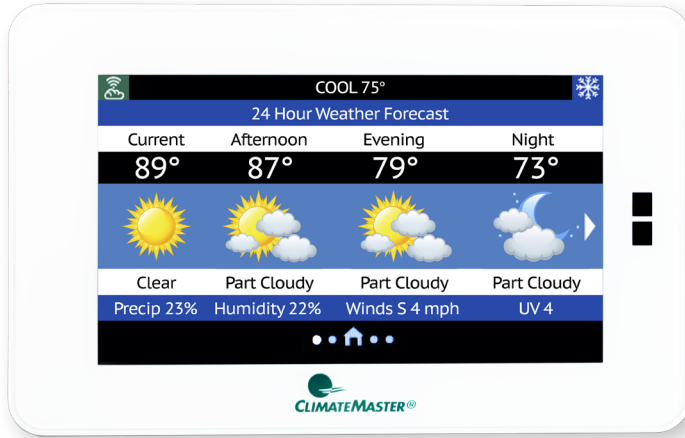

The iGate® 2 Communicating (AWC) Thermostat is innovating the future of comfort technology, one building at a time. The inspired design of the touch screen interface allows you to see real-time data for the efficiency and health of your system, with early warnings for potential system faults. The cloud based information gateway allows technicians to remotely diagnose system issues before occupants even know there is a problem. Control and monitor the system in your home or business from anywhere in the world with an easy to use app on your phone.

Features with Efficiency in Mind



Touch Screen Interface

A brilliantly customizable touch screen monitor for simple control.



Seamless Integration

Between your iGate® 2 Communicating (AWC) Thermostat and Tranquility comfort system.



(Mobile) Remote System Control

Control temperature and schedule from anywhere in the world.



Early Fault Warnings

Alerts you and your contractor of potential system faults in the future.



Remote Diagnostics

Enable the contractor to remotely diagnose system issues, adjust system settings, and reset faults.



Real-Time Operations Data & System Schematics

Access simply via the myUplink Pro Account and web portal to view system diagrams with current operating temperatures.



Revenue Stream

HVAC professionals can offer owners service contracts with remote monitoring and diagnosis capabilities without the large expense of a building management system.



HVAC Professional | User Experience

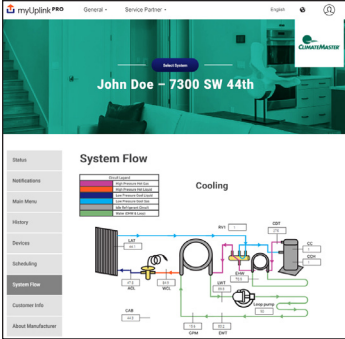

The iGate® 2 is more than just a smart thermostat for your residential or commercial customer, it's a business opportunity. Our new thermostat works with your customers' Tranquility comfort systems to provide the most efficient link between their system and

your services. The customization of monitoring from the myUplink PRO web portal or phone app account allows for continuous system monitoring, analysis, repair recognition, and early warnings for potential system faults that are sent to you and your customer.



Benefits

- Remote login from anywhere, anytime from any internet connected device
- View system fault history with possible root causes
- Information is available for contractors to troubleshoot and diagnosis systems remotely
- Secure internet connection keeps homeowner information private
- Access thermostat(s) through Android and iPhone mobile apps

Homeowner | User Experience

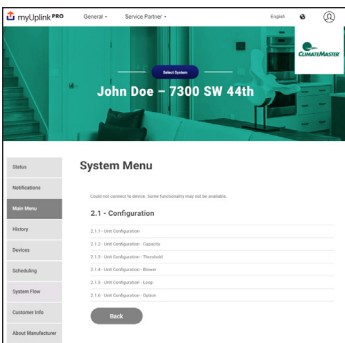

The iGate® 2 combines a Wi-Fi thermostat and advanced unit controls to communicate the systems operation information to the cloud. From any internet connected device or smart phone, homeowners can control and monitor their systems from anywhere in the

world. iGate 2 offers homeowners peace of mind their systems are operating at peak performance with advanced operational performance issue notifications. HVAC professionals get notifications when systems are operating out of range. They can log in remotely to check system faults, review current operating conditions, and diagnosis issues remotely. This gives the HVAC technician the upper hand when showing up to perform service, saving time which in turn saves money.



Benefits

- Communicates personal settings and reminders through the iGate 2 communication system
- Easy-to-use, full-color, high-resolution interface
- Sleek, intuitive button control
- Secure internet connection keeps your information private
- Contains unit model, serial number and your HVAC professionals contact information
- System monitoring automatically contacts HVAC system providers when service is needed

Selection Procedure

Reference Calculations

HEATING	
$LWT = EWT - \frac{HE}{GPM \times \text{Constant}}$	
$LAT = EAT + \frac{HC}{CFM \times 1.08}$	

COOLING	
$LWT = EWT + \frac{HR}{GPM \times \text{Constant}}$	$LC = TC - SC$
$LAT (DB) = EAT (DB) - \frac{SC}{CFM \times 1.08}$	$S/T = \frac{SC}{TC}$

Constant = 500 for water, 485 for antifreeze

Conversion Table - to convert inch-pound (English) to S-I (Metric)

Airflow	Water Flow	Est Static Pressure	Water Pressure Drop
Airflow (L/s) = CFM x 0.472	Water Flow (L/s) = gpm x 0.0631	ESP (Pa) = ESP (in of wg) x 249	PD (kPa) = PD (ft of hd) x 2.99

Legend and Glossary of Abbreviations

Abbreviations	Descriptions
BTUH	BTU (British Thermal Unit) per hour
CDT	Compressor discharge temperature
CFM	Airflow, cubic feet per minute
COP	Coefficient of performance = BTUH output/BTUH input
CT ECM	Electronic commutated constant torque fan motor
CV ECM	Electronic commutated constant volume fan motor
DB	Dry bulb temperature, °F
EAT	Entering air temperature
EER	Energy efficient ratio = BTUH output/Watt input
ESP	External static pressure, inches w.g.
EWT	Entering water temperature
FPT	Female pipe thread
GPM	Water flow in U.S., gallons per minute
HC	Air heating capacity, BTUH
HE	Total heat of extraction, BTUH
HR	Total heat of rejection, BTUH
HWC	Hot water generator (desuperheater) capacity, Mbtuh
KW	Total power unit input, kilowatts
LAT	Leaving air temperature, °F
LC	Latent cooling capacity, BTUH
LOC	Loss of charge
LWT	Leaving water temperature, °F
MBTUH	1,000 BTU per hour
MPT	Male pipe thread
MWV	Motorized water valve
PSC	Permanent split capacitor
SC	Sensible cooling capacity, BTUH
S/T	Sensible to total cooling ratio
TC	Total cooling capacity, BTUH
TD or delta T	Temperature differential
VFD	Variable frequency drive
WB	Wet bulb temperature, °F
WPD	Waterside pressure drop, psi or feet of head
WSE	Waterside economizer

Selection Procedure

- Step 1** Determine the actual heating and cooling loads at the desired dry bulb and wet bulb conditions.
- Step 2** Obtain the following design parameters: Entering water temperature, water flow rate in GPM, air flow in CFM, water flow pressure drop and design wet and dry bulb temperatures. Air flow CFM should be between 300 and 450 CFM per ton. Unit water pressure drop should be kept as close as possible to each other to make water balancing easier. Go to the appropriate tables and find the proper indicated water flow and water temperature.
- Step 3** Select a unit based on total and sensible cooling conditions. Select a unit which is closest to, but no larger than, the actual cooling load.
- Step 4** Enter tables at the design water flow and water temperature. Read the total and sensible cooling capacities (Note: interpolation is permissible, extrapolation is not).
- Step 5** Read the heating capacity. If it exceeds the design criteria it is acceptable. It is quite normal for Water-Source Heat Pumps to be selected on cooling capacity only since the heating output is usually greater than the cooling capacity.
- Step 6** Determine the correction factors associated with the variable factors of dry bulb and wet bulb.

 Corrected Total Cooling =
 tabulated total cooling x wet bulb correction.
 Corrected Sensible Cooling =
 tabulated sensible cooling x wet/dry bulb correction.
- Step 7** Compare the corrected capacities to the load requirements. Normally if the capacities are within 10% of the loads, the equipment is acceptable. It is better to undersize than oversize, as undersizing improves humidity control, reduces sound levels and extends the life of the equipment.
- Step 8** When completed, calculate water temperature rise and assess the selection. If the units selected are not within 10% of the load calculations, then review what effect changing the GPM, water temperature and/or air flow and air temperature would have on the corrected capacities. If the desired capacity cannot be achieved, select the next larger or smaller unit and repeat the procedure. Remember, when in doubt, undersize slightly for best performance.

Example Equipment Selection For Cooling Step 1 Load Determination:

Assume we have determined that the appropriate cooling load at the desired dry bulb 80°F and wet bulb 65°F conditions is as follows:

Total Cooling.....	56,900 BTUH
Sensible Cooling.....	49,400 BTUH
Entering Air Temp.....	80°F Dry Bulb / 65°F Wet Bulb

Step 2 Design Conditions:

Similarly, we have also obtained the following design parameters:

Entering Water Temp.....	90°F
Water Flow (based upon 12°F rise in temp.)	11 GPM
Air Flow	2,120 CFM

Steps 3, 4 & 5 HP Selection:

After making our preliminary selection (TRE05), we enter the tables at design water flow and water temperature and read Total Cooling, Sens. Cooling and Heat of Rej. capacities:

Total Cooling.....	57,000 BTUH
Sensible Cooling.....	45,000 BTUH
Heat of Rejection	73,200 BTUH

Steps 6 & 7 Entering Air and Airflow Corrections:

Next, we determine our correction factors.

	<u>Table</u>	<u>Ent Air</u>	<u>Air Flow</u>	<u>Corrected</u>
Corrected Total Cooling =	57,000	x 0.969	x 1.004	= 55,454
Corrected Sens Cooling =	45,000	x 1.090	x 1.030	= 50,522
Corrected Heat of Rej =	73,200	x 0.975	x 1.006	= 71,798

Step 8 Water Temperature Rise Calculation and Assessment:

Actual Temperature Rise.....	13.1°F
------------------------------	--------

When we compare the Corrected Total Cooling and Corrected Sensible Cooling figures with our load requirements stated in Step 1, we discover that our selection is within +/- 10% of our sensible load requirement. Furthermore, we see that our Corrected Total Cooling figure is slightly undersized as recommended, when compared to the actual indicated load.

ClimateMaster works continually to improve its products. As a result, the design and specifications of each product at the time of order may be changed without notice and may not be as described herein. Please contact ClimateMaster's Customer Service Department at 1-405-745-6000 for specific information on the current design and specifications. Statements and other information contained herein are not express warranties and do not form the basis of any bargain between the parties, but are merely ClimateMaster's opinion or commendation of its products. The latest version of this document is available at climatemaster.com. © ClimateMaster, Inc. All rights reserved 2010

TRE Series Nomenclature

1 2 3 4 5 6 7 8 9 10 11 12 13 14 15

TRE 036 D H D 1 A A A A S

SERIES
TRANQUILITY® ROOFTOP UNIT

UNIT SIZE
036
048
060
072
096
120
144
168
240

REVISION LEVEL
D= CURRENT REVISION

VOLTAGE
F = 460/60/3
H = 208-230/60/3 (FACTORY WIRED 208)
N = 575/60/3

CONTROLS
C = CXM2
D = DXM2.5
N = CXM2 w/MPC
P = DXM2.5 w/MPC

ETL APPROVED
USA & CANADA

CABINET & FILTER

OPTION	RANGE	THROWAWAY FILTER OPTIONS		
		2", (50mm) FILTER MERV 8	4", (50mm) FILTER MERV 8	4", (100mm) FILTER MERV 13
1	EXTENDED RANGE	YES	NO	NO
B		NO	YES	NO
C		NO	NO	YES
3	STANDARD RANGE	YES	NO	NO
D		NO	YES	NO
E		NO	NO	YES

STANDARD
S = STANDARD
B-Z = SPECIALS
A = HOT GAS BYPASS (on lead circuit only; std with ClimaDry® II option position 12)

POWER TERMINATION
A = NONE
B = DISCONNECT
C = DISCONNECT + GFI OUTLET
D = CIRCUIT BREAKER
E = CIRCUIT BREAKER + GFI OUTLET

AIR DAMPER OPTIONS
A = NONE
B = MANUAL ADJUSTABLE FRESH AIR DAMPER
C = MOTORIZED FRESH AIR DAMPER
F = MODULATING ENTHALPY ECONOMIZER

HEAT EXCHANGER OPTIONS

	NON-COATED AIR COILS		E-COATED AIR COILS	
	COPPER (CU) COAX	CUPRO-NICKEL (CN) COAX	COPPER (CU) COAX	CUPRO-NICKEL (CN) COAX
STANDARD	C	N	A	J
MOTORIZED VALVE	T	S	U	W
CLIMADRY® II	E	P	D	F
INTERNAL SECONDARY PUMP*	H	Z	G	Y

CLIMADRY® II OPTION COMPONENTS
REHEAT COIL
3-WAY MOTORIZED VALVE
PROPORTIONAL CONTROL
CIRCULATING PUMP
PUMP CONTACTOR
HOT GAS BYPASS
DMX2.5 CONTROL

BLOWER DRIVE PACKAGE
A = STANDARD RPM & STANDARD MOTOR
B = LOW RPM & STANDARD MOTOR
C = HIGH RPM & STANDARD MOTOR
D = STANDARD RPM & LARGE MOTOR**
E = HIGH RPM & LARGE MOTOR**

TRE Series Nomenclature

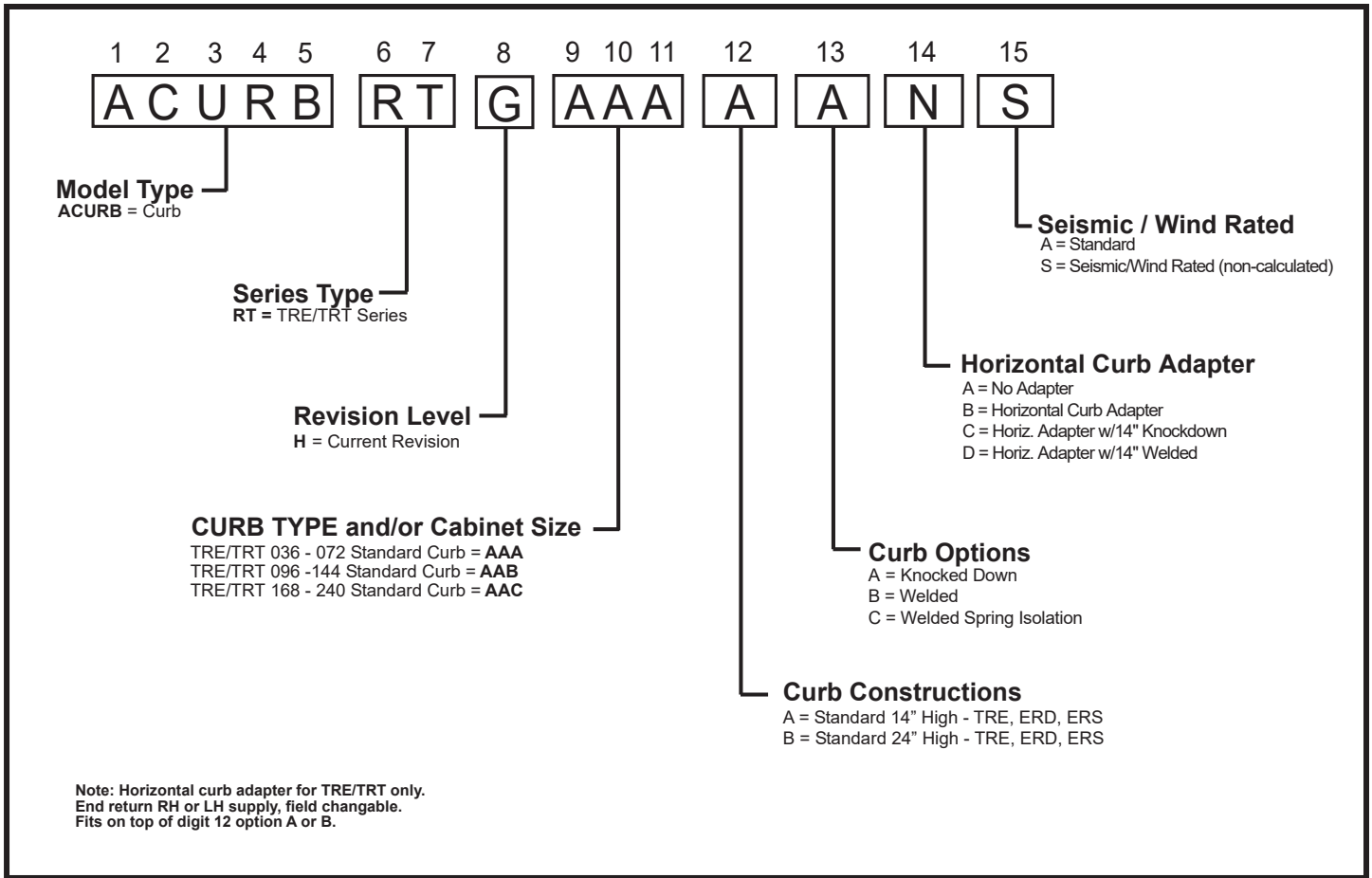

Performance Data – AHRI/ASHRAE/ISO 13256-1

AHRI/ASHRAE/ISO 13256-1. English (I-P) Units

Model	Water Loop Heat Pump				Ground Water Heat Pump				Ground Loop Heat Pump			
	Cooling 86°F		Heating 68°F		Cooling 59°F		Heating 50°F		Cooling 77°F		Heating 32°F	
	Capacity BTUH	EER BTUH/W	Capacity BTUH	COP	Capacity BTUH	EER BTUH/W	Capacity BTUH	COP	Capacity BTUH	EER BTUH/W	Capacity BTUH	COP
TRE036	35,000	14.2	42,700	5.0	39,800	21.7	35,400	4.4	35,000	16.5	28,100	3.6
TRE048	48,500	14.4	59,700	4.7	54,800	21.1	48,500	4.1	50,000	16.0	37,800	3.4
TRE060	61,100	15.7	72,800	5.1	69,800	23.5	60,100	4.5	62,100	17.6	45,600	3.6
TRE072	71,000	15.0	88,500	5.0	79,000	23.0	72,000	4.4	71,000	16.2	55,000	3.6
TRE096	97,000	14.0	110,600	4.4	108,600	20.6	91,700	3.9	101,000	15.6	74,000	3.2
TRE120	122,500	13.9	149,400	4.4	135,000	20.6	122,700	3.9	129,000	15.6	98,000	3.2
TRE144	141,000	13.8	180,000	4.5	158,000	20.0	145,000	4.0	144,000	15.2	113,000	3.3
TRE168	175,000	15.0	206,700	5.0	187,000	20.9	168,000	4.5	177,500	16.5	129,500	3.7
TRE240	241,000	13.6	287,000	4.8	276,000	19.3	230,000	4.2	249,500	15.0	182,400	3.4

AHRI/ASHRAE/ISO 13256-1. Metric (S-I) Units

Model	Water Loop Heat Pump				Ground Water Heat Pump				Ground Loop Heat Pump			
	Cooling 30°C		Heating 20°C		Cooling 15°C		Heating 10°C		Cooling 25°C		Heating 0°C	
	Capacity kW	EER W/W	Capacity kW	COP	Capacity kW	EER W/W	Capacity kW	COP	Capacity kW	EER W/W	Capacity kW	COP
TRE036	10.26	4.2	12.51	5.0	11.66	6.3	10.38	4.4	10.26	4.8	8.24	3.6
TRE048	14.21	4.2	17.50	4.7	16.06	6.2	14.21	4.1	14.65	4.7	11.08	3.4
TRE060	17.91	4.6	21.34	5.1	20.46	6.9	17.61	4.5	18.20	5.2	13.36	3.6
TRE072	20.80	4.4	25.93	5.0	23.15	6.7	21.10	4.4	20.80	4.7	16.12	3.6
TRE096	28.43	4.1	32.42	4.4	31.83	6.0	26.88	3.9	29.60	4.6	21.69	3.2
TRE120	35.90	4.1	43.79	4.4	39.57	6.0	35.96	3.9	37.81	4.6	28.72	3.2
TRE144	41.32	4.0	52.76	4.5	46.30	5.9	42.50	4.0	42.20	4.5	33.11	3.3
TRE168	51.29	4.4	60.58	5.0	54.81	6.1	49.24	4.5	52.02	4.8	37.95	3.7
TRE240	70.63	4.0	84.11	4.8	80.89	5.7	67.41	4.2	73.12	4.4	53.46	3.4

Note 1: Cooling capacities based upon 80.6°F DB, 66.2°F WB entering air temperature.

Note 2: Heating capacities based upon 68°F DB, 59°F WB entering air temperature.

Note 3: All ratings based upon operation at lower voltage of dual voltage rated models.

Performance Data – Selection Notes

For operation in the shaded area when water is used in lieu of an antifreeze solution, the LWT (Leaving Water Temperature) must be calculated. Flow must be maintained to a level such that the LWT is maintained above 42°F [5.6°C] when the JW3 jumper is not clipped (see example below). Otherwise, appropriate levels of a proper antifreeze solution should be used in systems with leaving water temperatures of 42°F [5.6°C] or below and the JW3 jumper should be clipped. This is due to the potential of the refrigerant temperature being as low as 32°F [0°C] with 40°F [4.4°C] LWT, which may lead to a nuisance cutout due to the activation of the Low Temperature Protection. JW3 should never be clipped for standard range equipment or systems without antifreeze.

Example:

At 50°F EWT (Entering Water Temperature) and 1.5 gpm/ton, a 3 ton unit has a HE of 22,500 Btuh. To calculate LWT, rearrange the formula for HE as follows:

$HE = TD \times GPM \times 500$, where HE = Heat of Extraction (Btuh); TD = temperature difference (EWT - LWT) and GPM = U.S. Gallons per Minute.

$$TD = HE / (GPM \times 500)$$

$$TD = 22,500 / (1.5 \times 500)$$

$$TD = 10^\circ\text{F}$$

$$LWT = EWT - TD$$

$$LWT = 50 - 10 = 40^\circ\text{F}$$

In this example, a higher flow rate will be required for EWTs at or below 50°F without antifreeze. At 2 gpm/ton, the calculation above results in a TD of 7.5. $LWT = 50 - 7.5 = 42.5^\circ\text{F}$, which is above 42°F EWT, and is acceptable for this application.

		Heating - EAT 70°F				
	EER	HC	kW	HE	LAT	COP
Shaded		21.8	2.11	14.6	86.8	3.02
		21.9	2.12	14.7	86.9	3.04
		23.5	2.15	16.2	88.2	3.20
		24.3	2.17	16.9	88.8	3.29
		24.7	2.18	17.3	89.1	3.33
	25.0	2.18	17.5	89.3	3.36	
4.5	21.0	26.6	2.22	19.1	90.5	3.52
8	22.5	27.6	2.23	20.0	91.3	3.63
	23.4	28.1	2.24	20.5	91.7	3.69
	23.9	28.5	2.24	20.8	92.0	3.72
8	29.6	29.6	2.26	21.9	92.8	3.83
	30.8	30.8	2.29	23.0	93.7	3.94
	33.0	33.0	2.30	23.6	94.5	4.05

Performance Data – TRE036

1200 CFM Nominal (Rated) Airflow

Performance capacities shown in thousands of Btuh

Water/Brine				Cooling - EAT 80/67°F					Heating - EAT 70°F				
EWT °F	Flow GPM	PD PSI	PD FT	TC	SC	kW	HR	EER	HC	kW	HE	LAT	COP
20	9.0	6.3	14.6	Operation not recommended					25.5	2.39	17.3	87.6	3.1
30	4.5	1.2	2.8	43.5	28.5	1.73	49.4	25.1	27.5	2.42	19.3	89.2	3.3
	6.8	3.2	7.5	43.6	28.7	1.66	49.3	26.2	28.6	2.43	20.3	90.0	3.4
	9.0	5.7	13.2	43.5	28.7	1.63	49.0	26.6	29.1	2.44	20.8	90.4	3.5
40	4.5	1.0	2.2	42.8	28.1	1.87	49.2	22.9	31.1	2.47	22.7	92.0	3.7
	6.8	2.7	6.3	43.4	28.4	1.77	49.4	24.6	32.5	2.49	24.0	93.0	3.8
	9.0	4.9	11.3	43.6	28.5	1.72	49.4	25.3	33.2	2.51	24.7	93.6	3.9
50	4.5	0.7	1.6	41.5	27.5	2.03	48.4	20.4	35.0	2.53	26.3	94.9	4.0
	6.8	2.2	5.1	42.5	27.9	1.91	49.0	22.3	36.6	2.56	27.9	96.2	4.2
	9.0	4.0	9.3	42.9	28.1	1.85	49.2	23.2	37.5	2.57	28.7	96.9	4.3
60	4.5	0.4	0.9	39.8	26.8	2.23	47.4	17.8	39.0	2.60	30.1	98.0	4.4
	6.8	1.8	4.1	41.1	27.3	2.09	48.2	19.7	40.9	2.63	31.9	99.5	4.6
	9.0	3.5	8.1	41.6	27.6	2.02	48.5	20.6	41.9	2.65	32.9	100.3	4.6
70	4.5	0.3	0.8	37.8	26.0	2.47	46.2	15.3	43.0	2.66	33.9	101.1	4.7
	6.8	1.6	3.8	39.2	26.6	2.30	47.1	17.0	45.1	2.70	35.9	102.7	4.9
	9.0	3.3	7.6	39.9	26.8	2.22	47.5	18.0	46.3	2.72	37.0	103.6	5.0
80	4.5	0.3	0.6	35.6	25.1	2.74	45.0	13.0	47.0	2.73	37.7	104.2	5.0
	6.8	1.5	3.5	37.1	25.7	2.55	45.8	14.5	49.3	2.78	39.8	105.9	5.2
	9.0	3.2	7.3	37.9	26.0	2.46	46.3	15.4	50.5	2.80	40.9	106.8	5.3
85	4.5	0.3	0.6	34.5	24.7	2.89	44.3	12.0	48.9	2.77	39.4	105.6	5.2
	6.8	1.5	3.4	36.0	25.3	2.70	45.2	13.4	51.2	2.82	41.6	107.4	5.3
	9.0	3.1	7.1	36.5	25.5	2.62	45.5	13.9	52.4	2.84	42.7	108.3	5.4
90	4.5	0.2	0.5	33.3	24.2	3.04	43.7	11.0	50.8	2.81	41.2	107.1	5.3
	6.8	1.4	3.3	34.8	24.8	2.84	44.5	12.3	53.1	2.86	43.4	108.9	5.5
	9.0	3.0	7.0	35.6	25.1	2.74	45.0	13.0	54.3	2.88	44.5	109.8	5.5
100	4.5	0.2	0.4	31.1	23.3	3.39	42.6	9.2	Operation not recommended				
	6.8	1.3	3.1	32.5	23.9	3.16	43.3	10.3					
	9.0	2.9	6.6	33.3	24.2	3.05	43.7	10.9					
110	4.5	0.1	0.3	29.0	22.5	3.77	41.8	7.7					
	6.8	1.3	3.0	30.3	23.0	3.52	42.3	8.6					
	9.0	2.8	6.5	31.0	23.3	3.41	42.6	9.1					
120	4.5	0.1	0.3	27.1	21.9	4.20	41.4	6.5					
	6.8	1.2	2.8	28.2	22.2	3.93	41.6	7.2					
	9.0	2.7	6.3	28.8	22.5	3.80	41.8	7.6					

Interpolation is permissible, extrapolation is not.
 All entering air conditions are 80°F DB and 67°F WB in cooling and 70°F DB in heating.
 All performance data is based upon the lower voltage of dual voltage rated units.
 See performance correction tables for operating conditions other than those listed above.
 See performance data selection notes for operation in shaded areas.

Performance Data – TRE048

1600 CFM Nominal (Rated) Airflow

Performance capacities shown in thousands of Btuh

Water/Brine				Cooling - EAT 80/67°F					Heating - EAT 70°F				
EWT °F	Flow GPM	PD PSI	PD FT	TC	SC	kW	HR	EER	HC	kW	HE	LAT	COP
20	12.0	12.6	29.1	Operation not recommended					34.5	3.42	22.8	87.9	3.0
30	6.0	3.3	7.6	56.8	36.5	2.44	65.1	23.3	37.2	3.47	25.4	89.5	3.1
	9.0	7.1	16.4	56.0	36.3	2.33	64.0	24.0	38.7	3.49	26.7	90.3	3.2
	12.0	11.4	26.4	55.4	36.1	2.28	63.2	24.3	39.4	3.51	27.5	90.8	3.3
40	6.0	2.7	6.2	56.8	36.5	2.63	65.8	21.6	42.1	3.56	30.0	92.3	3.5
	9.0	5.9	13.6	56.9	36.5	2.49	65.4	22.9	44.0	3.59	31.8	93.4	3.6
	12.0	9.7	22.4	56.7	36.4	2.43	65.0	23.4	45.1	3.61	32.8	94.0	3.7
50	6.0	2.1	4.8	55.9	36.4	2.85	65.6	19.6	47.5	3.66	35.0	95.4	3.8
	9.0	4.7	10.8	56.6	36.5	2.68	65.8	21.1	49.9	3.70	37.3	96.8	3.9
	12.0	8.0	18.4	56.9	36.5	2.61	65.8	21.8	51.2	3.73	38.5	97.6	4.0
60	6.0	1.5	3.5	54.2	36.0	3.11	64.8	17.4	53.2	3.77	40.4	98.7	4.1
	9.0	3.9	9.0	55.5	36.3	2.92	65.4	19.0	56.1	3.83	43.1	100.4	4.3
	12.0	7.0	16.1	56.0	36.4	2.83	65.6	19.8	57.8	3.86	44.6	101.3	4.4
70	6.0	1.4	3.2	52.0	35.3	3.41	63.7	15.3	59.2	3.89	46.0	102.2	4.5
	9.0	3.7	8.5	53.6	35.8	3.19	64.5	16.8	62.6	3.95	49.1	104.2	4.6
	12.0	6.6	15.3	54.4	36.0	3.09	64.9	17.6	64.5	3.99	50.9	105.3	4.7
80	6.0	1.3	3.0	49.5	34.4	3.75	62.3	13.2	65.4	4.01	51.7	105.7	4.8
	9.0	3.5	8.1	51.3	35.1	3.50	63.3	14.6	69.2	4.09	55.3	108.0	5.0
	12.0	6.4	14.7	52.2	35.4	3.39	63.7	15.4	71.4	4.13	57.3	109.2	5.1
85	6.0	1.3	2.9	48.1	33.8	3.9	61.6	12.3	68.5	4.1	54.6	107.5	4.9
	9.0	3.4	8.0	50.0	34.6	3.7	62.5	13.6	72.6	4.2	58.4	109.9	5.1
	12.0	6.3	14.4	50.7	34.8	3.59	62.9	14.1	74.9	4.2	60.5	111.2	5.2
90	6.0	1.2	2.8	46.7	33.2	4.13	60.8	11.3	71.6	4.13	57.5	109.3	5.1
	9.0	3.4	7.8	48.6	34.0	3.86	61.8	12.6	75.9	4.22	61.5	111.8	5.3
	12.0	6.2	14.2	49.6	34.4	3.73	62.3	13.3	78.3	4.27	63.7	113.2	5.4
100	6.0	1.2	2.7	43.9	31.8	4.56	59.5	9.6	Operation not recommended				
	9.0	3.2	7.5	45.8	32.8	4.27	60.4	10.7					
	12.0	6.0	13.8	46.8	33.2	4.13	60.9	11.3					
110	6.0	1.1	2.5	41.1	30.2	5.05	58.4	8.2					
	9.0	3.1	7.3	42.9	31.3	4.72	59.1	9.1					
	12.0	5.8	13.4	43.9	31.8	4.57	59.5	9.6					
120	6.0	1.0	2.4	38.6	28.5	5.59	57.7	6.9					
	9.0	3.0	7.0	40.2	29.6	5.23	58.1	7.7					
	12.0	5.7	13.1	41.1	30.2	5.06	58.3	8.1					

Interpolation is permissible, extrapolation is not.
 All entering air conditions are 80°F DB and 67°F WB in cooling and 70°F DB in heating.
 All performance data is based upon the lower voltage of dual voltage rated units.
 See performance correction tables for operating conditions other than those listed above.
 See performance data selection notes for operation in shaded areas.

Performance Data – TRE060

2000 CFM Nominal (Rated) Airflow

Performance capacities shown in thousands of Btuh

Water/Brine				Cooling - EAT 80/67°F					Heating - EAT 70°F				
EWT °F	Flow GPM	PD PSI	PD FT	TC	SC	kW	HR	EER	HC	kW	HE	LAT	COP
20	16.0	5.8	13.4	Operation not recommended					38.8	3.88	25.5	85.9	2.9
30	8.0	0.9	2.0	75.4	49.2	2.85	85.1	26.5	43.5	3.98	29.9	88.1	3.2
	12.0	2.8	6.6	73.9	47.9	2.72	83.1	27.2	45.4	4.02	31.7	89.0	3.3
	16.0	5.3	12.3	72.7	47.1	2.66	81.8	27.3	46.5	4.04	32.7	89.5	3.4
40	8.0	0.8	1.8	75.7	50.0	3.08	86.2	24.6	50.9	4.13	36.9	91.5	3.6
	12.0	2.5	5.8	75.7	49.5	2.91	85.6	26.0	53.5	4.18	39.2	92.7	3.7
	16.0	4.7	10.9	75.3	49.1	2.84	85.0	26.5	54.9	4.21	40.5	93.4	3.8
50	8.0	0.7	1.6	74.3	49.8	3.36	85.8	22.1	58.8	4.29	44.2	95.2	4.0
	12.0	2.2	5.0	75.5	50.0	3.16	86.2	23.9	62.0	4.35	47.1	96.6	4.2
	16.0	4.1	9.6	75.7	49.9	3.06	86.2	24.7	63.7	4.39	48.7	97.4	4.3
60	8.0	0.6	1.3	71.8	49.0	3.69	84.4	19.5	66.9	4.45	51.7	98.9	4.4
	12.0	2.0	4.5	73.7	49.7	3.45	85.5	21.4	70.5	4.53	55.1	100.6	4.6
	16.0	3.8	8.8	74.5	49.9	3.34	85.9	22.3	72.5	4.57	56.9	101.5	4.6
70	8.0	0.5	1.2	68.5	47.7	4.06	82.4	16.9	74.8	4.62	59.0	102.5	4.7
	12.0	1.9	4.3	70.9	48.7	3.79	83.9	18.7	78.8	4.71	62.8	104.4	4.9
	16.0	3.7	8.5	72.0	49.1	3.67	84.5	19.6	81.0	4.76	64.8	105.4	5.0
80	8.0	0.5	1.1	64.8	45.9	4.48	80.0	14.5	82.4	4.79	66.1	106.1	5.0
	12.0	1.8	4.2	67.4	47.1	4.19	81.6	16.1	86.6	4.88	69.9	108.0	5.2
	16.0	3.6	8.2	68.6	47.7	4.05	82.4	17.0	88.7	4.93	71.9	109.0	5.3
85	8.0	0.5	1.1	62.8	44.9	4.71	78.8	13.4	85.9	4.87	69.3	107.7	5.2
	12.0	1.8	4.1	65.4	46.2	4.41	80.4	14.9	90.0	4.97	73.0	109.5	5.3
	16.0	3.5	8.1	66.4	46.7	4.30	81.0	15.4	92.0	5.02	74.9	110.5	5.4
90	8.0	0.4	1.0	60.8	43.8	4.95	77.7	12.3	89.4	4.95	72.5	109.3	5.3
	12.0	1.8	4.1	63.4	45.2	4.63	79.2	13.7	93.3	5.05	76.1	111.1	5.4
	16.0	3.5	8.0	64.8	45.9	4.48	80.0	14.5	95.3	5.10	77.9	112.0	5.5
100	8.0	0.4	0.9	56.9	41.7	5.47	75.6	10.4	Operation not recommended				
	12.0	1.8	4.1	59.4	43.1	5.13	76.9	11.6					
	16.0	3.5	8.0	60.7	43.8	4.96	77.6	12.2					
110	8.0	0.4	0.8	53.4	39.7	6.06	74.1	8.8					
	12.0	1.7	3.9	55.5	40.9	5.69	74.9	9.8					
	16.0	3.4	7.8	56.7	41.6	5.51	75.5	10.3					
120	8.0	0.3	0.8	50.6	38.1	6.73	73.6	7.5					
	12.0	1.6	3.8	52.2	39.0	6.31	73.8	8.3					
	16.0	3.3	7.6	53.2	39.6	6.11	74.0	8.7					

Interpolation is permissible, extrapolation is not.
 All entering air conditions are 80°F DB and 67°F WB in cooling and 70°F DB in heating.
 All performance data is based upon the lower voltage of dual voltage rated units.
 See performance correction tables for operating conditions other than those listed above.
 See performance data selection notes for operation in shaded areas.

Performance Data – TRE072

2400 CFM Nominal (Rated) Airflow

Performance capacities shown in thousands of Btuh

EWT °F	Water / Brine			Cooling - EAT 80/67 °F					Heating - EAT 70°F					
	Flow GPM	PD PSI	PD FT	TC	SC	KW	HR	EER	HC	KW	HE	LAT	COP	
20	18.0	6.4	14.7	Operation Not Recommended					47.1	4.61	31.4	86.1	3.0	
	9.0	1.1	2.5	82.3	57.3	3.50	94.3	23.5	52.1	4.69	36.1	88.1	3.3	
	13.5	3.2	7.4	80.2	55.7	3.33	91.5	24.1	54.41	4.73	38.3	89.0	3.4	
30	18.0	5.8	13.5	78.6	54.7	3.26	89.7	24.1	55.8	4.76	39.5	89.5	3.4	
	9.0	0.8	1.8	83.2	58.3	3.78	96.1	22.0	60.7	4.87	44.1	91.4	3.7	
	13.5	2.5	5.8	82.8	57.7	3.58	95.0	23.1	63.9	4.94	47.1	92.6	3.8	
40	18.0	4.8	11.1	82.2	57.2	3.49	94.1	23.6	65.7	4.98	48.7	93.3	3.9	
	9.0	0.5	1.1	82.1	58.3	4.10	96.1	20.0	70.0	5.09	52.7	95.0	4.0	
	13.5	1.8	4.2	83.1	58.4	3.87	96.2	21.5	74.0	5.19	56.3	96.5	4.2	
50	18.0	3.7	8.7	83.2	58.3	3.76	96.0	22.1	76.3	5.25	58.4	97.4	4.3	
	9.0	0.3	0.7	79.6	57.5	4.46	94.8	17.8	79.7	5.34	61.5	98.7	4.4	
	13.5	1.5	3.4	81.5	58.1	4.20	95.8	19.4	84.4	5.46	65.7	100.5	4.5	
60	18.0	3.4	7.8	82.2	58.3	4.07	96.1	20.2	86.9	5.53	68.0	101.5	4.6	
	9.0	0.3	0.6	76.0	56.1	4.87	92.7	15.6	89.2	5.59	70.1	102.3	4.7	
	13.5	1.3	3.1	78.6	57.1	4.58	94.2	17.2	94.3	5.73	74.8	104.3	4.8	
70	18.0	3.2	7.4	79.7	57.5	4.44	94.9	18.0	97.0	5.80	77.2	105.3	4.9	
	9.0	0.2	0.6	71.9	54.4	5.33	90.1	13.5	98.3	5.83	78.4	105.8	4.9	
	13.5	1.3	2.9	74.8	55.6	5.01	91.9	14.9	103.4	5.97	83.0	107.8	5.1	
80	18.0	3.1	7.1	76.2	56.2	4.86	92.7	15.7	106.0	6.03	85.4	108.8	5.2	
	9.0	0.2	0.5	67.4	52.6	5.86	87.4	11.5	106.4	6.04	85.8	108.9	5.2	
	13.5	1.2	2.7	70.4	53.8	5.51	89.2	12.8	111.0	6.14	90.0	110.7	5.3	
85	18.0	2.9	6.8	71.9	54.4	5.33	90.1	13.5	113.1	6.18	92.0	111.5	5.4	
	9.0	0.2	0.4	63.0	50.7	6.46	85.0	9.7	No data					
	13.5	1.2	2.7	65.8	51.9	6.07	86.5	10.8	No data					
90	18.0	2.8	6.6	67.3	52.5	5.88	87.4	11.4	No data					
	9.0	0.1	0.3	58.8	49.0	7.15	83.2	8.2	No data					
	13.5	1.1	2.6	61.4	50.0	6.71	84.3	9.1	No data					
100	18.0	2.8	6.4	62.7	50.6	6.50	84.9	9.7	No data					
	Operation Not Recommended				No data					No data				
	13.5	1.1	2.6	57.4	48.5	7.44	82.7	7.7	No data					
110	18.0	2.7	6.2	58.6	48.9	7.20	83.1	8.1	No data					
	Operation Not Recommended				No data					No data				
120	Operation Not Recommended				No data					No data				
	Operation Not Recommended				No data					No data				

Interpolation is permissible, extrapolation is not.
 All entering air conditions are 80°F DB and 67°F WB in cooling and 70°F DB in heating.
 All performance data is based upon the lower voltage of dual voltage rated units.
 See performance correction tables for operating conditions other than those listed above.
 See performance data selection notes for operation in shaded areas.

Performance Data – TRE096

3200 CFM Nominal (Rated) Airflow

Performance capacities shown in thousands of Btu/h

Water/Brine				Cooling - EAT 80/67°F					Heating - EAT 70°F				
EWT °F	Flow GPM	PD PSI	PD FT	TC	SC	kW	HR	EER	HC	kW	HE	LAT	COP
20	24.0	12.3	28.4	Operation not recommended					66.8	7.02	42.8	87.3	2.8
30	12.0	2.9	6.7	114.6	76.4	5.03	131.7	22.8	72.6	7.12	48.4	89.0	3.0
	18.0	6.6	15.2	113.6	75.3	4.78	129.9	23.7	75.4	7.16	50.9	89.8	3.1
	24.0	11.0	25.4	112.7	74.6	4.67	128.6	24.1	76.9	7.19	52.4	90.2	3.1
40	12.0	2.3	5.3	114.4	76.9	5.40	132.8	21.2	82.7	7.28	57.8	91.9	3.3
	18.0	5.4	12.4	114.7	76.6	5.12	132.2	22.4	86.3	7.34	61.2	92.9	3.4
	24.0	9.2	21.2	114.5	76.3	4.99	131.5	22.9	88.3	7.38	63.1	93.5	3.5
50	12.0	1.6	3.8	112.6	76.4	5.83	132.6	19.3	93.4	7.47	67.9	95.0	3.7
	18.0	4.2	9.7	114.1	76.9	5.50	132.9	20.7	97.8	7.55	72.1	96.2	3.8
	24.0	7.3	16.9	114.5	76.9	5.36	132.8	21.4	100.2	7.59	74.3	96.9	3.9
60	12.0	1.1	2.7	109.5	75.2	6.35	131.2	17.2	104.4	7.67	78.3	98.1	4.0
	18.0	3.5	8.1	111.9	76.2	5.96	132.3	18.8	109.5	7.77	83.0	99.6	4.1
	24.0	6.6	15.1	112.9	76.5	5.78	132.6	19.5	112.2	7.82	85.5	100.4	4.2
70	12.0	1.0	2.4	105.1	73.4	6.98	128.9	15.0	115.3	7.89	88.3	101.3	4.3
	18.0	3.3	7.6	108.4	74.8	6.52	130.6	16.6	120.6	8.00	93.4	102.8	4.4
	24.0	6.2	14.4	109.8	75.4	6.30	131.3	17.4	123.5	8.06	96.0	103.6	4.5
80	12.0	1.0	2.2	99.5	70.9	7.73	125.9	12.9	125.4	8.11	97.8	104.2	4.5
	18.0	3.2	7.3	103.6	72.7	7.18	128.1	14.4	130.8	8.23	102.7	105.8	4.7
	24.0	6.0	13.8	105.4	73.5	6.93	129.1	15.2	133.4	8.30	105.1	106.5	4.7
85	12.0	0.9	2.1	96.2	69.4	8.17	124.1	11.8	130.0	8.22	101.9	105.5	4.6
	18.0	3.1	7.2	100.6	71.4	7.58	126.5	13.3	135.0	8.35	106.5	107.0	4.7
	24.0	5.9	13.6	102.8	72.4	7.29	127.6	14.1	137.4	8.42	108.7	107.7	4.8
90	12.0	0.9	2.0	93.0	67.9	8.62	122.4	10.8	134.5	8.33	106.1	106.8	4.7
	18.0	3.0	7.0	97.6	70.1	7.99	124.9	12.2	139.2	8.47	110.3	108.2	4.8
	24.0	5.8	13.4	99.8	71.1	7.69	126.1	13.0	141.3	8.54	112.2	108.8	4.9
100	12.0	0.8	1.9	85.5	64.4	9.67	118.5	8.8	Operation not recommended				
	18.0	2.9	6.7	90.6	66.9	8.94	121.2	10.1					
	24.0	5.6	13.0	93.1	68.0	8.60	122.5	10.8					
110	12.0	0.8	1.8	77.3	60.3	10.90	114.5	7.1					
	18.0	2.8	6.5	82.7	63.1	10.08	117.1	8.2					
	24.0	5.5	12.7	85.4	64.4	9.68	118.5	8.8					
120	Operation not allowed												
	18.0	2.7	6.3	74.0	58.6	11.41	112.925	6.5					
	24.0	5.3	12.4	76.9	60.1	10.96	114.266	7.0					

Interpolation is permissible, extrapolation is not.

All entering air conditions are 80°F DB and 67°F WB in cooling and 70°F DB in heating.

All performance data is based upon the lower voltage of dual voltage rated units.

See performance correction tables for operating conditions other than those listed above.

See performance data selection notes for operation in shaded areas.

Note: TRE096 will not run at 1.5GPM/Ton @ 120EWT so there is no data to display.

Performance Data – TRE120

4000 CFM Nominal (Rated) Airflow

Performance capacities shown in thousands of Btuh

Water/Brine				Cooling - EAT 80/67°F					Heating - EAT 70°F				
EWT °F	Flow GPM	PD PSI	PD FT	TC	SC	kW	HR	EER	HC	kW	HE	LAT	COP
20	30.0	3.8	8.7	Operation not recommended					87.7	9.23	56.2	88.3	2.8
30	15.0	0.7	1.7	145.1	92.6	6.59	167.6	22.0	94.9	9.37	62.9	89.9	3.0
	22.5	1.6	3.7	144.7	90.3	6.33	166.3	22.9	98.4	9.44	66.2	90.7	3.1
	30.0	3.4	7.8	143.9	88.5	6.23	165.2	23.1	100.4	9.48	68.1	91.2	3.1
40	15.0	0.6	1.4	143.3	93.5	7.05	167.3	20.3	107.2	9.62	74.4	92.8	3.3
	22.5	1.2	2.8	144.9	93.0	6.69	167.7	21.7	111.8	9.72	78.6	93.8	3.4
	30.0	2.7	6.2	145.1	92.2	6.53	167.4	22.2	114.3	9.77	81.0	94.4	3.4
50	15.0	0.5	1.2	139.5	92.7	7.61	165.4	18.3	120.4	9.90	86.6	95.8	3.6
	22.5	0.8	1.8	142.5	93.4	7.16	167.0	19.9	126.0	10.02	91.8	97.1	3.7
	30.0	2.0	4.7	143.7	93.5	6.97	167.5	20.6	129.1	10.09	94.7	97.8	3.7
60	15.0	0.3	0.7	134.3	90.6	8.28	162.5	16.2	134.1	10.20	99.3	99.0	3.9
	22.5	0.5	1.2	138.3	92.3	7.76	164.8	17.8	140.8	10.35	105.5	100.5	4.0
	30.0	1.7	4.0	140.1	92.9	7.52	165.8	18.6	144.5	10.44	108.9	101.4	4.1
70	15.0	0.3	0.6	128.0	87.8	9.05	158.9	14.1	148.3	10.52	112.4	102.3	4.1
	22.5	0.5	1.1	132.7	90.0	8.47	161.6	15.7	156.1	10.70	119.5	104.0	4.3
	30.0	1.6	3.8	135.0	90.9	8.19	162.9	16.5	160.3	10.81	123.4	105.0	4.3
80	15.0	0.2	0.5	121.2	84.8	9.93	155.1	12.2	162.8	10.86	125.7	105.6	4.4
	22.5	0.4	1.0	126.2	87.0	9.28	157.9	13.6	171.5	11.08	133.7	107.6	4.5
	30.0	1.5	3.6	128.7	88.1	8.97	159.3	14.3	176.2	11.20	138.0	108.7	4.6
85	15.0	0.2	0.5	117.6	83.2	10.43	153.2	11.3	170.0	11.04	132.3	107.3	4.5
	22.5	0.4	0.9	122.6	85.4	9.75	155.9	12.6	179.2	11.27	140.7	109.4	4.7
	30.0	1.5	3.5	125.2	86.6	9.41	157.3	13.3	184.1	11.40	145.2	110.5	4.7
90	15.0	0.1	0.3	114.0	81.7	10.92	151.3	10.4	177.3	11.22	139.0	108.9	4.6
	22.5	0.4	0.9	119.1	83.9	10.21	153.9	11.7	186.8	11.47	147.7	111.1	4.8
	30.0	1.5	3.4	121.7	85.0	9.87	155.3	12.3	192.0	11.60	152.5	112.4	4.9
100	15.0	0.1	0.2	107.0	79.1	12.02	148.0	8.9	Operation not recommended				
	22.5	0.3	0.8	111.8	80.9	11.25	150.2	9.9					
	30.0	1.4	3.3	114.4	81.9	10.87	151.5	10.5					
110	15.0	0.1	0.2	100.5	77.2	13.24	145.6	7.6					
	22.5	0.3	0.7	104.8	78.4	12.40	147.1	8.5					
	30.0	1.4	3.2	107.2	79.1	12.00	148.1	8.9					
120	15.0	0.1	0.1	94.8	76.6	14.59	144.6	6.5					
	22.5	0.3	0.7	98.5	76.9	13.67	145.1	7.2					
	30.0	1.3	3.0	100.5	77.2	13.23	145.6	7.6					

Interpolation is permissible, extrapolation is not.
 All entering air conditions are 80°F DB and 67°F WB in cooling and 70°F DB in heating.
 All performance data is based upon the lower voltage of dual voltage rated units.
 See performance correction tables for operating conditions other than those listed above.
 See performance data selection notes for operation in shaded areas.

Performance Data – TRE144

4800 CFM Nominal (Rated) Airflow

Performance capacities shown in thousands of Btuh

EWT °F	Water / Brine			Cooling - EAT 80/67 °F					Heating - EAT 70°F				
	Flow GPM	PD PSI	PD FT	TC	SC	KW	HR	EER	HC	KW	HE	LAT	COP
20	36.0	8.0	18.6	Operation Not Recommended					97.1	10.63	60.8	86.7	2.7
	18.0	2.0	4.7	160.9	107.3	7.82	187.6	20.6	107.4	10.95	70.1	88.7	2.9
	27.0	4.4	10.2	160.4	108.0	7.52	186.1	21.3	111.7	11.07	73.9	89.5	3.0
30	36.0	7.3	16.9	159.7	108.3	7.38	184.9	21.6	114.0	11.13	76.0	89.9	3.0
	18.0	1.7	3.9	159.2	105.9	8.34	187.6	19.1	123.0	11.36	84.2	91.7	3.2
	27.0	3.8	8.8	160.6	106.9	7.97	187.8	20.2	128.1	11.48	89.0	92.7	3.3
40	36.0	6.4	14.7	160.9	107.4	7.80	187.5	20.6	130.9	11.55	91.5	93.2	3.3
	18.0	1.3	3.1	155.2	104.1	8.95	185.7	17.3	138.7	11.72	98.7	94.7	3.5
	27.0	3.2	7.3	158.2	105.4	8.52	187.2	18.6	144.9	11.85	104.5	95.9	3.6
50	36.0	5.4	12.5	159.3	105.9	8.32	187.6	19.2	148.3	11.92	107.6	96.5	3.6
	18.0	1.1	2.5	149.5	102.1	9.68	182.5	15.4	154.9	12.06	113.7	97.8	3.8
	27.0	2.7	6.3	153.6	103.5	9.17	184.9	16.7	162.3	12.22	120.7	99.2	3.9
60	36.0	4.9	11.2	155.4	104.2	8.93	185.8	17.4	166.5	12.31	124.5	100.0	4.0
	18.0	1.0	2.3	142.5	99.8	10.53	178.4	13.5	171.8	12.42	129.4	101.1	4.1
	27.0	2.6	6.0	147.3	101.4	9.94	181.3	14.8	180.8	12.63	137.7	102.8	4.2
70	36.0	4.7	10.8	149.6	102.2	9.67	182.6	15.5	185.9	12.75	142.4	103.8	4.3
	18.0	1.0	2.2	134.5	97.2	11.51	173.8	11.7	189.7	12.84	145.9	104.5	4.3
	27.0	2.5	5.8	139.8	99.0	10.85	176.9	12.9	200.6	13.13	155.9	106.6	4.5
80	36.0	4.5	10.4	142.4	99.8	10.53	178.4	13.5	206.9	13.30	161.5	107.8	4.6
	18.0	0.9	2.1	126.0	94.3	12.65	169.1	10.0	No data				
	27.0	2.4	5.5	131.5	96.2	11.90	172.1	11.0	208.9	13.36	163.3	108.2	4.6
85	36.0	4.4	10.2	137.6	98.2	11.12	175.6	12.4	222.1	13.75	175.2	110.7	4.7
	18.0	0.9	2.0	117.1	91.0	13.95	164.7	8.4	229.7	13.99	182.0	112.2	4.8
	27.0	2.3	5.3	122.6	93.0	13.12	167.4	9.3	Operation Not Recommended				
36.0	4.2	9.7	125.4	94.1	12.72	168.8	9.9						
18.0	0.8	1.9	108.3	87.6	15.46	161.0	7.0						
100	27.0	2.2	5.2	113.6	89.7	14.52	163.1	7.8	Operation Not Recommended				
	36.0	4.1	9.5	116.3	90.7	14.08	164.4	8.3					
	18.0	0.8	1.9	108.3	87.6	15.46	161.0	7.0					
110	Operation Not Recommended			Operation Not Recommended					Operation Not Recommended				
	36.0	4.0	9.3										
120	Operation Not Recommended			Operation Not Recommended					Operation Not Recommended				
36.0	4.0	9.3	107.4										

Interpolation is permissible, extrapolation is not.
 All entering air conditions are 80°F DB and 67°F WB in cooling and 70°F DB in heating.
 All performance data is based upon the lower voltage of dual voltage rated units.
 See performance correction tables for operating conditions other than those listed above.
 See performance data selection notes for operation in shaded areas.

Performance Data – TRE168

5600 CFM Nominal (Rated) Airflow

Performance capacities shown in thousands of Btu/h

Water/Brine				Cooling - EAT 80/67°F					Heating - EAT 70°F				
EWT °F	Flow GPM	PD PSI	PD FT	TC	SC	kW	HR	EER	HC	kW	HE	LAT	COP
20	42.0	11.5	26.5	Operation not recommended					112.0	10.20	77.2	86.5	3.2
30	21.0	2.8	6.6	180.4	129.3	7.99	207.6	22.6	121.9	10.41	86.4	88.1	3.4
	31.5	6.2	14.3	171.8	128.1	7.73	198.2	22.2	126.9	10.52	91.0	88.9	3.5
	42.0	10.3	23.9	166.8	127.3	7.63	192.8	21.9	129.7	10.58	93.6	89.4	3.6
40	21.0	2.3	5.3	188.0	130.3	8.56	217.2	22.0	139.9	10.80	103.1	91.1	3.8
	31.5	5.2	12.1	183.6	129.7	8.16	211.4	22.5	146.6	10.94	109.3	92.2	3.9
	42.0	8.9	20.5	180.5	129.3	8.00	207.8	22.6	150.3	11.02	112.7	92.8	4.0
50	21.0	1.8	4.1	190.2	130.9	9.28	221.8	20.5	159.5	11.23	121.2	94.3	4.2
	31.5	4.3	9.9	189.2	130.5	8.76	219.1	21.6	167.7	11.41	128.8	95.7	4.3
	42.0	7.4	17.2	187.9	130.3	8.54	217.0	22.0	172.2	11.51	132.9	96.4	4.4
60	21.0	1.3	3.1	188.1	131.2	10.16	222.8	18.5	179.4	11.68	139.6	97.6	4.5
	31.5	3.7	8.5	189.9	131.0	9.53	222.4	19.9	188.6	11.90	148.0	99.1	4.6
	42.0	6.7	15.4	190.2	130.9	9.24	221.7	20.6	193.4	12.01	152.4	99.9	4.7
70	21.0	1.2	2.9	183.0	130.9	11.18	221.1	16.4	198.5	12.14	157.0	100.7	4.8
	31.5	3.5	8.0	186.9	131.2	10.44	222.5	17.9	207.6	12.38	165.4	102.3	4.9
	42.0	6.4	14.7	188.4	131.2	10.10	222.8	18.6	212.3	12.51	169.6	103.0	5.0
80	21.0	1.2	2.7	175.5	129.6	12.34	217.6	14.2	215.2	12.60	172.2	103.5	5.0
	31.5	3.3	7.7	180.9	130.6	11.51	220.2	15.7	223.2	12.85	179.3	104.8	5.1
	42.0	6.2	14.2	183.3	130.9	11.12	221.3	16.5	226.7	12.98	182.4	105.4	5.1
85	21.0	1.1	2.5	170.9	128.4	12.99	215.3	13.2	221.7	12.8	177.9	104.6	5.1
	31.5	3.3	7.6	176.9	129.8	12.12	218.2	14.6	228.0	13.1	183.5	105.6	5.1
	42.0	6.0	14.0	179.8	130.5	11.69	219.7	15.4	230.5	13.2	185.5	106.0	5.1
90	21.0	1.1	2.5	166.4	127.2	13.64	212.9	12.2	228.1	13.04	183.6	105.6	5.1
	31.5	3.2	7.4	172.8	129.0	12.73	216.2	13.6	232.9	13.27	187.6	106.4	5.1
	42.0	6.0	13.8	175.8	129.7	12.29	217.8	14.3	234.3	13.38	188.6	106.6	5.1
100	21.0	1.0	2.4	156.2	123.3	15.09	207.7	10.3	Operation not recommended				
	31.5	3.1	7.2	163.1	126.0	14.10	211.2	11.6					
	42.0	5.8	13.4	166.5	127.2	13.62	213.0	12.2					
110	21.0	1.0	2.4	145.4	118.0	16.70	202.4	8.7					
	31.5	3.0	7.0	152.5	121.6	15.63	205.8	9.8					
	42.0	5.7	13.1	156.0	123.2	15.11	207.6	10.3					
120	Operation not allowed			141.5	115.7	17.33	200.6	8.2					
	31.5	2.9	6.8										
	42.0	5.6	12.8										

Interpolation is permissible, extrapolation is not.

All entering air conditions are 80°F DB and 67°F WB in cooling and 70°F DB in heating.

All performance data is based upon the lower voltage of dual voltage rated units.

See performance correction tables for operating conditions other than those listed above.

See performance data selection notes for operation in shaded areas.

Note: TRE168 will not run at 1.5GPM/Ton @ 120EWT so there is no data to display.

Performance Data – TRE240

8000 CFM Nominal (Rated) Airflow

Performance capacities shown in thousands of Btuh

Water/Brine				Cooling - EAT 80/67°F					Heating - EAT 70°F									
EWT °F	Flow GPM	PD PSI	PD FT	TC	SC	kW	HR	EER	HC	kW	HE	LAT	COP					
20	60.0	10.2	23.5	Operation not recommended					158.1	16.10	103.2	86.3	2.9					
30	30.0	2.7	6.3	254.7	182.7	12.65	297.9	20.1	170.9	16.42	114.8	87.7	3.0					
	45.0	5.6	13.0	243.6	172.9	11.70	283.5	20.8	176.6	16.56	120.1	88.4	3.1					
	60.0	9.2	21.4	236.6	166.9	11.24	274.9	21.1	179.7	16.63	123.0	88.8	3.2					
40	30.0	2.3	5.3	263.0	190.6	13.99	310.8	18.8	193.5	16.94	135.7	90.3	3.3					
	45.0	4.8	11.2	258.5	186.2	13.11	303.2	19.7	201.3	17.10	143.0	91.3	3.5					
	60.0	8.0	18.4	254.8	182.8	12.66	298.0	20.1	205.7	17.20	147.0	91.8	3.5					
50	30.0	1.8	4.3	263.2	191.9	15.25	315.2	17.3	219.0	17.48	159.3	93.3	3.7					
	45.0	4.0	9.3	263.8	191.6	14.38	312.9	18.3	229.0	17.69	168.6	94.4	3.8					
	60.0	6.7	15.5	262.9	190.5	13.95	310.5	18.8	234.5	17.81	173.8	95.1	3.9					
60	30.0	1.5	3.5	257.6	188.8	16.50	313.9	15.6	246.1	18.05	184.5	96.4	4.0					
	45.0	3.5	8.2	262.0	191.3	15.62	315.3	16.8	258.3	18.31	195.8	97.8	4.1					
	60.0	6.2	14.2	263.3	191.9	15.19	315.1	17.3	264.9	18.46	202.0	98.6	4.2					
70	30.0	1.5	3.3	248.0	183.1	17.82	308.8	13.9	274.1	18.66	210.4	99.7	4.3					
	45.0	3.4	7.9	255.0	187.3	16.89	312.7	15.1	288.1	18.98	223.3	101.3	4.4					
	60.0	5.9	13.7	257.9	189.0	16.44	314.0	15.7	295.6	19.15	230.3	102.1	4.5					
80	30.0	1.4	3.2	235.9	176.1	19.27	301.6	12.2	302.1	19.31	236.2	102.9	4.6					
	45.0	3.3	7.6	244.4	181.0	18.26	306.7	13.4	317.3	19.68	250.1	104.6	4.7					
	60.0	5.7	13.2	248.4	183.3	17.78	309.0	14.0	325.4	19.89	257.5	105.6	4.8					
85	30.0	1.4	3.2	229.1	172.5	20.08	297.6	11.4	315.6	19.65	248.6	104.4	4.7					
	45.0	3.3	7.6	237.9	177.3	19.03	302.8	12.5	331.0	20.05	262.6	106.2	4.8					
	60.0	5.6	13.0	242.4	179.9	18.50	305.5	13.1	339.1	20.28	269.9	107.2	4.9					
90	30.0	1.4	3.1	222.2	168.9	20.90	293.6	10.6	329.1	19.99	260.9	106.0	4.8					
	45.0	3.2	7.3	231.4	173.7	19.79	298.9	11.7	344.8	20.42	275.1	107.8	4.9					
	60.0	5.6	12.9	235.9	176.2	19.26	301.6	12.3	352.9	20.67	282.4	108.7	5.0					
100	30.0	1.3	3.0	208.2	162.2	22.79	286.0	9.1	Operation not recommended									
	45.0	3.1	7.2	217.3	166.4	21.54	290.8	10.1										
	60.0	5.5	12.6	221.9	168.7	20.94	293.4	10.6										
110	30.0	1.3	2.9	194.9	157.2	25.00	280.2	7.8										
	45.0	3.0	7.0	203.1	160.2	23.56	283.5	8.6										
	60.0	5.4	12.4	207.6	162.0	22.89	285.6	9.1										
120	Operation not allowed																	
	45.0	3.0	6.9	190.2	156.0	25.95	278.7	7.3										
	60.0	5.3	12.2	194.0	157.0	25.16	279.9	7.7										

Interpolation is permissible, extrapolation is not.

All entering air conditions are 80°F DB and 67°F WB in cooling and 70°F DB in heating.

All performance data is based upon the lower voltage of dual voltage rated units

See performance correction tables for operating conditions other than those listed above.

See performance data selection notes for operation in shaded areas.

Note: TRE240 will not run at 1.5GPM/Ton @ 120EWT so there is no data to display.

Antifreeze Correction Table

EWT	Antifreeze Type	Antifreeze %	Cooling			Heating		WPD
			Total Cap	Sensible Cap	Watts	Total Cap	Watts	
90	Water	0%	1	1	1	1	1	1
	Ethanol	5%	0.998	0.998	1.002	0.996	0.999	1.025
		10%	0.996	0.996	1.003	0.991	0.997	1.048
		15%	0.994	0.994	1.005	0.987	0.996	1.098
		20%	0.991	0.991	1.006	0.982	0.994	1.142
		25%	0.986	0.986	1.009	0.972	0.991	1.207
		30%	0.981	0.981	1.012	0.962	0.988	1.265
		35%	0.977	0.977	1.015	0.953	0.985	1.312
		40%	0.972	0.972	1.018	0.943	0.982	1.37
		45%	0.966	0.966	1.023	0.931	0.978	1.431
	50%	0.959	0.959	1.027	0.918	0.974	1.494	
	Ethylene Glycol	5%	0.998	0.998	1.002	0.996	0.999	1.021
		10%	0.996	0.996	1.003	0.991	0.997	1.04
		15%	0.994	0.994	1.004	0.987	0.996	1.079
		20%	0.991	0.991	1.005	0.982	0.995	1.114
		25%	0.988	0.988	1.008	0.976	0.993	1.146
		30%	0.985	0.985	1.01	0.969	0.99	1.175
		35%	0.982	0.982	1.012	0.963	0.988	1.208
		40%	0.979	0.979	1.014	0.956	0.986	1.243
		45%	0.976	0.976	1.016	0.95	0.984	1.278
	50%	0.972	0.972	1.018	0.943	0.982	1.314	
	Methanol	5%	0.997	0.997	1.002	0.993	0.998	1.039
		10%	0.993	0.993	1.004	0.986	0.996	1.075
		15%	0.99	0.99	1.007	0.979	0.994	1.116
		20%	0.986	0.986	1.009	0.972	0.991	1.154
		25%	0.982	0.982	1.012	0.964	0.989	1.189
		30%	0.978	0.978	1.014	0.955	0.986	1.221
		35%	0.974	0.974	1.017	0.947	0.984	1.267
		40%	0.97	0.97	1.02	0.939	0.981	1.31
		45%	0.966	0.966	1.023	0.93	0.978	1.353
	50%	0.961	0.961	1.026	0.92	0.975	1.398	
	Propylene Glycol	5%	0.995	0.995	1.003	0.99	0.997	1.065
		10%	0.99	0.99	1.006	0.98	0.994	1.119
		15%	0.986	0.986	1.009	0.971	0.991	1.152
		20%	0.981	0.981	1.012	0.962	0.988	1.182
		25%	0.978	0.978	1.014	0.956	0.986	1.227
		30%	0.975	0.975	1.016	0.95	0.984	1.267
		35%	0.972	0.972	1.018	0.944	0.982	1.312
		40%	0.969	0.969	1.02	0.938	0.98	1.356
		45%	0.965	0.965	1.023	0.929	0.977	1.402
	50%	0.96	0.96	1.026	0.919	0.974	1.45	

Table Continued on Next Page

Antifreeze Correction Table

Table Continued from Previous Page

EWT	Antifreeze Type	Antifreeze %	Cooling			Heating		WPD
			Total Cap	Sensible Cap	Watts	Total Cap	Watts	
30	Water	0%	1	1	1	1	1	1
	Ethanol	5%	0.991	0.991	1.006	0.981	0.994	1.14
		10%	0.981	0.981	1.012	0.961	0.988	1.242
		15%	0.973	0.973	1.018	0.944	0.983	1.295
		20%	0.964	0.964	1.024	0.927	0.977	1.343
		25%	0.959	0.959	1.028	0.917	0.974	1.363
		30%	0.954	0.954	1.031	0.907	0.97	1.383
		35%	0.949	0.949	1.035	0.897	0.967	1.468
		40%	0.944	0.944	1.038	0.887	0.964	1.523
		45%	0.94	0.94	1.041	0.88	0.962	1.58
		50%	0.936	0.936	1.043	0.872	0.959	1.639
	Ethylene Glycol	5%	0.997	0.997	1.002	0.993	0.998	1.04
		10%	0.993	0.993	1.004	0.986	0.996	1.075
		15%	0.99	0.99	1.006	0.98	0.994	1.122
		20%	0.987	0.987	1.008	0.973	0.992	1.163
		25%	0.983	0.983	1.011	0.966	0.99	1.195
		30%	0.979	0.979	1.013	0.958	0.987	1.225
		35%	0.976	0.976	1.016	0.951	0.985	1.279
		40%	0.972	0.972	1.018	0.943	0.982	1.324
		45%	0.969	0.969	1.021	0.937	0.98	1.371
		50%	0.966	0.966	1.023	0.93	0.978	1.419
	Methanol	5%	0.995	0.995	1.004	0.989	0.997	1.069
		10%	0.989	0.989	1.007	0.978	0.993	1.127
		15%	0.984	0.984	1.011	0.968	0.99	1.164
		20%	0.979	0.979	1.014	0.957	0.986	1.197
		25%	0.975	0.975	1.017	0.949	0.984	1.216
		30%	0.971	0.971	1.019	0.941	0.981	1.235
		35%	0.967	0.967	1.022	0.933	0.979	1.286
		40%	0.963	0.963	1.025	0.924	0.976	1.323
		45%	0.959	0.959	1.028	0.917	0.974	1.36
		50%	0.955	0.955	1.03	0.91	0.971	1.399
	Propylene Glycol	5%	0.995	0.995	1.004	0.989	0.997	1.071
		10%	0.989	0.989	1.007	0.978	0.993	1.13
		15%	0.985	0.985	1.01	0.968	0.99	1.206
		20%	0.98	0.98	1.013	0.958	0.987	1.27
		25%	0.974	0.974	1.017	0.947	0.983	1.359
		30%	0.968	0.968	1.021	0.935	0.979	1.433
		35%	0.963	0.963	1.025	0.924	0.976	1.522
		40%	0.957	0.957	1.029	0.913	0.972	1.614
		45%	0.949	0.949	1.034	0.898	0.967	1.712
		50%	0.941	0.941	1.039	0.882	0.962	1.816

Correction Table – Additional Water Pressure Drop

Additional Water Pressure Drop

Model	GPM	Motorized Water Valve Option			ClimaDry® II Option	
		CV	PSI	FT	PSI	FT
TRE036	4.50	5	0.8	1.8	0.87	2.00
	6.75	5	1.8	4.2	1.99	4.60
	9.00	5	3.2	7.4		
TRE048	6.00	5	1.4	3.3	1.55	3.60
	9.00	5	3.2	7.4	3.49	8.10
	12.00	5	5.8	13.4		
TRE060	8.00	8	1.0	2.3	1.70	3.90
	12.00	8	2.3	5.3	3.82	8.80
	16.00	8	4.0	9.2		
TRE072	9.00	25	0.4	0.8	2.15	5.00
	13.50	25	0.5	1.2	4.83	11.20
	18.00	25	0.7	1.7		
TRE096	12.00	41	0.3	0.7	1.04	2.40
	18.00	41	0.4	1.0	2.35	5.40
	24.00	41	0.6	1.4		
TRE120	15.00	41	0.4	0.8	1.63	3.80
	22.50	41	0.5	1.3	3.67	8.50
	30.00	41	0.7	1.7		
TRE144	18.00	41	0.4	1.0	2.35	5.40
	27.00	41	0.7	1.5	5.28	12.20
	36.00	41	0.9	2.0		
TRE168	21.00	57	0.4	0.9	2.73	6.30
	31.50	57	0.6	1.3	6.14	14.20
	42.00	57	0.7	1.7		
TRE240	30.00	57	0.5	1.2	2.89	6.70
	45.00	57	0.8	1.8	6.50	15.00
	60.00	57	1.1	2.4		

Blower Performance Data – TRE036

Airflow in CFM with wet coil and clean air filter

SCFM	ESP	0.00	0.10	0.20	0.30	0.40	0.50	0.60	0.70	0.80	0.90	1.00	1.10	1.20	1.30	1.40	1.50
900	BHP	0.10	0.13	0.16	0.17	0.19	0.22	0.24	0.26	0.28	0.30	0.33	0.35	0.37	0.40	0.44	0.47
	Sheave/Mtr	B	B	B	A	A	A	A	A	A	A	C	C	C	C	C	C
	RPM	552	615	665	715	765	820	875	925	965	1010	1055	1100	1140	1180	1220	1260
	Turns Open	4.5	3.5	3.0	4.5	4.0	3.5	2.5	2.0	1.5	1.0	3.0	2.5	2.0	2.0	1.5	1.0
1000	BHP	0.16	0.17	0.19	0.21	0.23	0.25	0.28	0.30	0.33	0.36	0.40	0.43	0.46	0.49	0.52	0.55
	Sheave/Mtr	B	B	A	A	A	A	A	A	A	A	C	C	C	C	C	C
	RPM	615	655	695	740	790	845	900	940	985	1030	1070	1115	1150	1190	1230	1265
	Turns Open	3.5	3.0	5.0	4.0	3.5	3.0	2.0	1.5	1.0	0.5	3.0	2.5	2.0	1.5	1.5	1.0
1100	BHP	0.22	0.23	0.25	0.29	0.32	0.34	0.35	0.36	0.38	0.41	0.44	0.48	0.50	0.53	0.56	0.59
	Sheave/Mtr	B	A	A	A	A	A	A	A	A	C	C	C	C	C	C	C
	RPM	685	725	765	810	855	895	940	985	1025	1065	1105	1145	1180	1215	1250	1285
	Turns Open	2.5	5.0	4.0	3.5	2.5	2.5	1.5	1.0	0.5	3.0	2.5	2.0	1.5	1.5	1.0	0.5
1200	BHP	0.26	0.27	0.30	0.33	0.36	0.39	0.42	0.44	0.48	0.51	0.54	0.57	0.60	0.62	0.65	0.69
	Sheave/Mtr	A	A	A	A	A	A	A	A	C	C	C	C	C	C	C	C
	RPM	710	740	785	830	880	920	965	1005	1045	1085	1125	1160	1195	1230	1265	1300
	Turns Open	5.0	4.5	3.5	3.0	2.5	2.0	1.0	0.5	3.5	3.0	2.5	2.0	1.5	1.0	1.0	0.5
1300	BHP	0.30	0.33	0.36	0.40	0.42	0.44	0.46	0.50	0.55	0.61	0.65	0.68	0.71	0.74	0.76	0.79
	Sheave/Mtr	A	A	A	A	A	A	A	A	C	C	C	C	C	C	C	C
	RPM	750	790	830	870	910	950	990	1030	1065	1105	1140	1175	1210	1245	1280	1315
	Turns Open	4.0	3.5	3.0	2.5	2.0	1.5	1.0	0.5	3.0	2.5	2.0	1.5	1.5	1.0	0.5	0.0
1400	BHP	0.40	0.42	0.44	0.47	0.50	0.53	0.56	0.60	0.64	0.67	0.70	0.72	0.75	0.79	0.84	0.88
	Sheave/Mtr	A	A	A	A	A	A	A	C	C	C	C	C	C	C	C	C
	RPM	820	850	875	915	950	990	1025	1065	1100	1135	1170	1205	1235	1270	1305	1335
	Turns Open	3.0	2.5	2.5	2.0	1.5	1.0	0.5	3.0	2.5	2.0	2.0	1.5	1.0	0.5	0.5	0.0
1500	BHP	0.45	0.47	0.50	0.52	0.55	0.59	0.64	0.69	0.74	0.77	0.80	0.83	0.86	0.90	0.93	
	Sheave/Mtr	A	A	A	A	A	A	C	C	C	C	C	C	C	C	C	
	RPM	860	885	920	955	985	1020	1055	1090	1125	1160	1190	1225	1255	1290	1320	
	Turns Open	2.5	2.0	2.0	1.5	1.0	0.5	3.0	2.5	2.0	2.0	1.5	1.0	1.0	0.5	0.0	

A = Standard RPM/Standard Motor, B = Low RPM/Standard Motor, C = High RPM/Standard Motor, D = Standard RPM/Large Motor, E = High RPM/Large Motor
 Unit shipped with standard drive package with drive sheave 2.5 turns open unless otherwise requested. Field adjustment may be required for specified CFM.
 ISO/AHRI rating point with standard drive package and drive sheave open 3.0 turns @ .30 ESP.
 Performance data does not include drive losses and is based on sea level conditions.
 Operation in black areas not permitted.
 All airflow is rated at lowest voltage if unit is dual rated, i.e. rated at 208 volts for 208-230 volt units.

Blower Performance Data – TRE048

Airflow in CFM with wet coil and clean air filter

SCFM	ESP	0.00	0.10	0.20	0.30	0.40	0.50	0.60	0.70	0.80	0.90	1.00	1.10	1.20	1.30	1.40	1.50
1200	BHP	0.27	0.31	0.34	0.37	0.40	0.42	0.45	0.48	0.52	0.55	0.58	0.60	0.63	0.66	0.70	0.73
	Sheave/Mtr	B	B	A	A	A	A	A	A	A	A	A	C	C	C	C	C
	RPM	750	800	845	890	935	975	1015	1055	1095	1135	1170	1205	1240	1275	1310	1345
	Turns Open	5.0	4.0	5.0	4.0	3.5	3.0	2.5	1.5	1.0	0.5	0.0	3.0	2.5	2.0	1.5	1.5
1300	BHP	0.35	0.38	0.41	0.43	0.45	0.47	0.53	0.59	0.64	0.67	0.70	0.72	0.75	0.78	0.80	0.83
	Sheave/Mtr	B	A	A	A	A	A	A	A	A	A	C	C	C	C	C	C
	RPM	810	850	890	930	970	1010	1050	1090	1125	1160	1195	1230	1265	1300	1330	1365
	Turns Open	4.0	4.5	4.0	3.5	3.0	2.5	2.0	1.0	0.5	0.0	3.0	3.0	2.5	2.0	1.5	1.0
1400	BHP	0.43	0.46	0.49	0.52	0.55	0.58	0.62	0.66	0.68	0.71	0.74	0.77	0.82	0.86	0.91	0.96
	Sheave/Mtr	A	A	A	A	A	A	A	A	A	C	C	C	C	C	C	C
	RPM	865	900	935	970	1010	1045	1085	1120	1155	1190	1220	1255	1290	1320	1355	1390
	Turns Open	4.5	4.0	3.5	3.0	2.5	2.0	1.5	0.5	0.0	3.5	3.0	2.5	2.0	1.5	1.0	1.0
1500	BHP	0.49	0.52	0.54	0.57	0.62	0.68	0.73	0.76	0.79	0.82	0.85	0.89	0.92	0.96	1.00	1.05
	Sheave/Mtr	A	A	A	A	A	A	A	A	C	C	C	C	C	C	E	E
	RPM	910	945	975	1010	1045	1080	1115	1150	1180	1215	1250	1280	1310	1345	1375	1405
	Turns Open	3.5	3.5	3.0	2.5	2.0	1.5	1.0	0.0	3.5	3.0	2.5	2.0	2.0	1.5	1.0	0.5
1600	BHP	0.62	0.65	0.67	0.70	0.72	0.75	0.78	0.82	0.86	0.89	0.94	1.00	1.04	1.08	1.13	1.18
	Sheave/Mtr	A	A	A	A	A	A	A	C	C	C	C	E	E	E	E	E
	RPM	960	985	1015	1050	1080	1115	1145	1175	1210	1240	1275	1305	1335	1365	1395	1425
	Turns Open	3.0	2.5	2.5	2.0	2.0	1.5	0.5	3.5	3.0	2.5	2.5	2.0	1.5	1.0	0.5	0.5
1700	BHP	0.74	0.77	0.80	0.83	0.85	0.88	0.90	0.93	0.95	1.00	1.06	1.11	1.17	1.22	1.27	1.31
	Sheave/Mtr	A	A	A	A	A	A	C	C	C	E	E	E	E	E	E	E
	RPM	1000	1030	1060	1090	1115	1150	1180	1210	1240	1270	1300	1330	1360	1390	1420	1445
	Turns Open	2.5	2.0	1.5	1.5	1.0	1.0	3.5	3.0	3.0	2.5	2.0	1.5	1.0	1.0	0.5	0.0
1800	BHP	0.83	0.87	0.90	0.94	0.98	1.02	1.06	1.09	1.14	1.18	1.23	1.28	1.32	1.36		
	Sheave/Mtr	A	A	A	A	A	E	E	E	E	E	E	E	E	E		
	RPM	1050	1075	1100	1125	1155	1185	1215	1245	1275	1300	1330	1360	1385	1415		
	Turns Open	2.0	1.5	1.0	0.5	0.5	3.5	3.0	2.5	2.5	2.0	1.5	1.0	1.0	0.5		
1900	BHP	0.97	1.00	1.03	1.08	1.12	1.16	1.20	1.25	1.29	1.34	1.38	1.42				
	Sheave/Mtr	A	D	D	E	E	E	E	E	E	E	E	E				
	RPM	1100	1120	1145	1175	1200	1225	1250	1280	1305	1335	1360	1385				
	Turns Open	1.0	1.0	0.5	3.5	3.0	3.0	2.5	2.0	2.0	1.5	1.0	1.0				
2000	BHP	1.13	1.17	1.20	1.24	1.28	1.32	1.36	1.40	1.44							
	Sheave/Mtr	D	D	E	E	E	E	E	E	E							
	RPM	1145	1170	1190	1215	1235	1260	1290	1315	1340							
	Turns Open	0.5	0.5	3.0	3.0	2.5	2.5	2.0	1.5	1.5							

A = Standard RPM/Standard Motor, B = Low RPM/Standard Motor, C = High RPM/Standard Motor, D = Standard RPM/Large Motor, E = High RPM/Large Motor
 Unit shipped with standard drive package with drive sheave 2.5 turns open unless otherwise requested. Field adjustment may be required for specified CFM.

ISO/AHRI rating point with standard drive package and drive sheave open 3.0 turns @ .30 ESP.

Performance data does not include drive losses and is based on sea level conditions.

Operation in black areas not permitted.

All airflow is rated at lowest voltage if unit is dual rated, i.e. rated at 208 volts for 208-230 volt units.

Blower Performance Data – TRE060

Airflow in CFM with wet coil and clean air filter

SCFM	ESP	0.00	0.10	0.20	0.30	0.40	0.50	0.60	0.70	0.80	0.90	1.00	1.10	1.20	1.30	1.40	1.50
1500	BHP	0.17	0.22	0.26	0.29	0.31	0.34	0.37	0.40	0.44	0.47	0.50	0.53	0.56	0.60	0.63	0.65
	Sheave/Mtr	B	B	B	B	A	A	A	A	A	A	A	A	A	C	C	C
	RPM	516	573	625	670	710	755	785	820	850	880	900	925	945	970	990	1010
	Turns Open	5.0	4.5	3.5	2.5	4.5	4.0	3.5	3.0	2.0	1.5	1.5	1.0	0.5	3.0	2.5	2.5
1600	BHP	0.20	0.24	0.28	0.32	0.35	0.38	0.41	0.45	0.48	0.52	0.55	0.58	0.62	0.65	0.68	0.70
	Sheave/Mtr	B	B	B	A	A	A	A	A	A	A	A	A	C	C	C	C
	RPM	526	583	635	680	725	765	795	830	860	890	915	940	965	990	1010	1030
	Turns Open	5.0	4.5	3.5	5.0	4.5	3.5	3.0	2.5	2.0	1.5	1.0	0.5	3.0	2.5	2.5	2.0
1700	BHP	0.23	0.26	0.30	0.34	0.38	0.42	0.45	0.49	0.53	0.56	0.60	0.64	0.67	0.71	0.73	0.75
	Sheave/Mtr	B	B	B	A	A	A	A	A	A	A	A	A	C	C	C	C
	RPM	536	589	640	685	730	770	805	840	875	900	930	955	980	1005	1025	1045
	Turns Open	4.5	4.0	3.0	5.0	4.0	3.5	3.0	2.5	2.0	1.5	1.0	0.5	3.0	2.5	2.0	2.0
1800	BHP	0.25	0.29	0.33	0.37	0.41	0.46	0.50	0.54	0.58	0.62	0.65	0.68	0.72	0.76	0.78	0.81
	Sheave/Mtr	B	B	B	A	A	A	A	A	A	A	A	C	C	C	C	C
	RPM	547	599	650	695	740	780	815	855	885	915	940	965	995	1020	1040	1060
	Turns Open	4.5	4.0	3.0	4.5	4.0	3.5	2.5	2.0	1.5	1.0	0.5	3.0	2.5	2.0	2.0	1.5
1900	BHP	0.29	0.32	0.37	0.41	0.46	0.50	0.55	0.59	0.62	0.66	0.70	0.73	0.77	0.81	0.85	0.88
	Sheave/Mtr	B	B	B	A	A	A	A	A	A	A	A	C	C	C	C	C
	RPM	568	620	665	710	755	790	830	865	895	925	955	985	1015	1035	1060	1080
	Turns Open	4.5	3.5	3.0	4.5	3.5	3.0	2.5	2.0	1.5	1.0	0.5	2.5	2.0	2.0	1.5	1.0
2000	BHP	0.33	0.36	0.42	0.47	0.52	0.57	0.61	0.66	0.69	0.73	0.77	0.81	0.85	0.89	0.92	0.96
	Sheave/Mtr	B	B	A	A	A	A	A	A	A	A	C	C	C	C	C	C
	RPM	589	635	680	725	765	805	845	880	910	940	975	1005	1030	1055	1075	1100
	Turns Open	4.0	3.5	5.0	4.0	3.5	3.0	2.0	1.5	1.0	0.5	3.0	2.5	2.0	1.5	1.5	1.0
2100	BHP	0.41	0.45	0.49	0.52	0.57	0.63	0.68	0.72	0.76	0.80	0.84	0.88	0.92	0.96	1.00	1.04
	Sheave/Mtr	B	B	A	A	A	A	A	A	A	A	C	C	C	C	E	E
	RPM	615	660	700	740	780	820	860	895	925	960	990	1020	1045	1070	1095	1120
	Turns Open	3.5	3.0	4.5	4.0	3.0	2.5	2.0	1.5	1.0	0.5	2.5	2.0	2.0	1.5	1.0	0.5
2200	BHP	0.44	0.49	0.54	0.58	0.64	0.69	0.74	0.78	0.83	0.87	0.91	0.96	1.00	1.04	1.08	1.12
	Sheave/Mtr	B	A	A	A	A	A	A	A	A	C	C	C	E	E	E	E
	RPM	640	680	720	760	800	840	880	910	945	975	1005	1035	1060	1085	1115	1135
	Turns Open	3.0	5.0	4.5	3.5	3.0	2.5	1.5	1.0	0.5	3.0	2.5	2.0	1.5	1.5	1.0	0.5
2300	BHP	0.52	0.56	0.60	0.65	0.70	0.75	0.80	0.85	0.89	0.94	1.00	1.05	1.11	1.16	1.22	1.25
	Sheave/Mtr	B	A	A	A	A	A	A	A	C	C	E	E	E	E	E	E
	RPM	665	705	745	785	825	860	895	930	960	995	1025	1050	1080	1105	1135	1155
	Turns Open	3.0	4.5	4.0	3.5	2.5	2.0	1.5	0.5	3.0	2.5	2.0	2.0	1.5	1.0	0.5	0.5
2400	BHP	0.57	0.62	0.67	0.73	0.79	0.84	0.89	1.00	1.00	1.03	1.08	1.14	1.20	1.26	1.30	1.35
	Sheave/Mtr	A	A	A	A	A	A	A	D	D	E	E	E	E	E	E	E
	RPM	695	735	775	810	850	885	920	950	980	1015	1040	1070	1100	1130	1150	1175
	Turns Open	5.0	4.0	3.5	3.0	2.0	1.5	1.0	0.5	0.0	2.0	2.0	1.5	1.0	0.5	0.5	0.0
2500	BHP	0.64	0.69	0.75	0.81	0.87	0.92	1.00	1.01	1.05	1.11	1.17	1.23	1.29	1.34	1.39	1.43
	Sheave/Mtr	A	A	A	A	A	A	D	D	E	E	E	E	E	E	E	E
	RPM	725	765	800	835	870	905	940	970	1000	1030	1060	1090	1120	1145	1170	1190
	Turns Open	4.5	3.5	3.0	2.5	2.0	1.5	0.5	0.0	2.5	2.0	1.5	1.0	0.5	0.5	0.0	0.0

A = Standard RPM/Standard Motor, B = Low RPM/Standard Motor, C = High RPM/Standard Motor, D = Standard RPM/Large Motor, E = High RPM/Large Motor
 Unit shipped with standard drive package with drive sheave 2.5 turns open unless otherwise requested. Field adjustment may be required for specified CFM.
 ISO/AHRI rating point with standard drive package and drive sheave open 3.0 turns @ .30 ESP.

Performance data does not include drive losses and is based on sea level conditions.

Operation in black areas not permitted.

All airflow is rated at lowest voltage if unit is dual rated, i.e. rated at 208 volts for 208-230 volt units.

Blower Performance Data – TRE072

Airflow in CFM with wet coil and clean air filter

SCFM	ESP	0.00	0.10	0.20	0.30	0.40	0.50	0.60	0.70	0.80	0.90	1.00	1.10	1.20	1.30	1.40	1.50
1800	BHP	0.27	0.31	0.35	0.39	0.43	0.47	0.51	0.55	0.59	0.62	0.66	0.70	0.74	0.76	0.79	0.83
	Sheave/Mtr	B	B	B	B	A	A	A	A	A	A	A	A	A	C	C	C
	RPM	568	620	665	710	755	790	830	865	895	920	950	975	1005	1025	1045	1070
	Turns Open	5.0	3.5	2.5	1.5	5.0	4.0	3.5	3.0	2.5	2.0	1.0	0.5	0.0	4.0	4.0	3.5
1900	BHP	0.29	0.33	0.37	0.42	0.46	0.50	0.55	0.59	0.63	0.67	0.70	0.74	0.77	0.81	0.85	0.89
	Sheave/Mtr	B	B	B	B	A	A	A	A	A	A	A	A	C	C	C	C
	RPM	573	625	670	715	755	795	830	870	900	930	960	990	1015	1040	1060	1085
	Turns Open	4.5	3.5	2.5	1.5	5.0	4.0	3.5	a3.0	2.0	1.5	1.0	0.5	4.5	4.0	3.5	3.5
2000	BHP	0.32	0.36	0.41	0.46	0.51	0.56	0.60	0.65	0.69	0.72	0.76	0.80	0.84	0.88	0.92	0.96
	Sheave/Mtr	B	B	B	B	A	A	A	A	A	A	A	A	C	C	C	C
	RPM	583	630	675	720	760	800	835	875	905	935	970	1000	1025	1050	1075	1100
	Turns Open	4.5	3.0	2.0	1.0	4.5	3.5	3.0	2.5	2.0	1.5	0.5	0.0	4.0	3.5	3.5	3.0
2100	BHP	0.39	0.44	0.47	0.51	0.56	0.61	0.66	0.71	0.75	0.79	0.83	0.87	0.91	0.95	0.99	1.03
	Sheave/Mtr	B	B	B	B	A	A	A	A	A	A	A	C	C	C	C	C
	RPM	599	645	685	725	770	805	845	885	915	950	980	1010	1035	1060	1085	1110
	Turns Open	4.0	3.0	2.0	1.0	4.5	3.5	3.0	2.5	1.5	1.0	0.5	4.5	4.0	3.5	3.0	3.0
2200	BHP	0.42	0.47	0.52	0.56	0.62	0.67	0.72	0.77	0.81	0.85	0.89	0.93	0.98	1.02	1.06	1.11
	Sheave/Mtr	B	B	B	A	A	A	A	A	A	A	A	C	C	C	C	C
	RPM	620	665	705	745	785	825	865	900	930	960	995	1020	1050	1075	1100	1130
	Turns Open	3.5	2.5	1.5	5.0	4.0	3.5	2.5	2.0	1.5	1.0	0.0	4.0	3.5	3.5	3.0	2.5
2300	BHP	0.49	0.54	0.58	0.62	0.67	0.72	0.78	0.82	0.87	0.91	0.97	1.02	1.08	1.13	1.19	1.23
	Sheave/Mtr	B	B	B	A	A	A	A	A	A	A	C	C	C	C	C	C
	RPM	640	685	725	765	800	840	880	910	945	975	1010	1035	1065	1090	1120	1145
	Turns Open	3.0	2.0	1.0	4.5	4.0	3.0	2.5	2.0	1.0	0.5	4.5	4.0	3.5	3.0	2.5	2.5
2400	BHP	0.54	0.58	0.62	0.68	0.74	0.79	0.85	0.90	0.94	0.99	1.04	1.10	1.15	1.21	1.27	1.31
	Sheave/Mtr	B	B	A	A	A	A	A	A	A	A	C	C	C	C	C	C
	RPM	660	700	740	780	820	855	890	925	955	990	1020	1050	1075	1105	1135	1155
	Turns Open	2.5	1.5	5.0	4.5	3.5	3.0	2.0	1.5	1.0	0.5	4.0	3.5	3.5	3.0	2.5	2.0
2500	BHP	0.59	0.64	0.69	0.75	0.81	0.87	0.92	0.96	1.01	1.05	1.11	1.17	1.23	1.29	1.34	1.39
	Sheave/Mtr	B	B	A	A	A	A	A	A	A	A	C	C	C	C	C	C
	RPM	680	725	765	800	835	870	905	935	970	1000	1030	1060	1090	1120	1145	1170
	Turns Open	2.0	1.0	4.5	4.0	3.5	3.0	2.0	1.5	0.5	0.0	4.0	3.5	3.0	C	2.0	2.0
2600	BHP	0.64	0.69	0.75	0.80	0.86	0.92	0.97	1.02	1.08	1.13	1.19	1.25	1.30	1.36	1.41	1.50
	Sheave/Mtr	B	A	A	A	A	A	A	A	A	C	C	C	C	C	C	E
	RPM	700	740	780	815	850	885	920	950	985	1015	1045	1075	1100	1130	1155	1180
	Turns Open	1.5	5.0	4.5	3.5	3.0	2.5	2.0	1.0	0.5	4.5	3.5	3.0	3.0	2.5	2.0	1.5
2700	BHP	0.70	0.75	0.80	0.86	0.91	0.97	1.02	1.08	1.14	1.20	1.26	1.32	1.38	1.50	1.52	1.56
	Sheave/Mtr	B	A	A	A	A	A	A	A	C	C	C	C	C	E	E	E
	RPM	725	760	795	830	865	900	930	960	995	1025	1055	1085	1115	1140	1165	1190
	Turns Open	1.0	4.5	4.0	3.5	3.0	2.0	1.5	1.0	4.5	4.0	3.5	3.0	2.5	2.0	2.0	1.5
2800	BHP	0.76	0.82	0.88	0.93	0.98	1.05	1.10	1.16	1.22	1.30	1.37	1.44	1.50	1.56	1.63	1.69
	Sheave/Mtr	A	A	A	A	A	A	A	A	C	C	C	C	E	E	E	E
	RPM	745	780	815	850	880	915	945	980	1010	1040	1070	1100	1125	1150	1180	1205
	Turns Open	5.0	4.0	3.5	3.0	2.5	1.5	1.0	0.5	4.5	4.0	3.5	3.0	2.5	2.0	1.5	1.5
2900	BHP	0.82	0.88	0.93	0.98	1.05	1.11	1.17	1.23	1.30	1.37	1.44	1.51	1.59	1.65	1.71	1.77
	Sheave/Mtr	A	A	A	A	A	A	A	C	C	C	C	E	E	E	E	E
	RPM	765	800	830	865	900	930	960	990	1020	1050	1080	1110	1140	1165	1190	1215
	Turns Open	4.5	4.0	3.5	2.5	2.0	1.5	0.5	4.5	4.0	3.5	3.0	2.5	2.5	2.0	1.5	1.0
3000	BHP	0.91	0.96	1.02	1.07	1.13	1.20	1.26	1.32	1.38	1.46	1.53	1.60	1.66	1.72	1.78	1.84
	Sheave/Mtr	A	A	A	A	A	A	A	C	C	C	E	E	E	E	E	E
	RPM	785	820	855	885	915	950	980	1010	1035	1065	1095	1125	1150	1175	1200	1225
	Turns Open	4.0	3.5	3.0	2.5	2.0	1.0	0.5	4.0	4.0	3.5	3.0	2.5	2.0	1.5	1.5	1.0

A = Standard RPM/Standard Motor, B = Low RPM/Standard Motor, C = High RPM/Standard Motor, D = Standard RPM/Large Motor, E = High RPM/Large Motor
 Unit shipped with standard drive package with drive sheave 2.5 turns open unless otherwise requested. Field adjustment may be required for specified CFM.
 ISO/AHRI rating point with standard drive package and drive sheave open 3.0 turns @ .30 ESP.

Performance data does not include drive losses and is based on sea level conditions.

Operation in black areas not permitted.

All airflow is rated at lowest voltage if unit is dual rated, i.e. rated at 208 volts for 208-230 volt units.

ClimateMaster works continually to improve its products. As a result, the design and specifications of each product at the time of order may be changed without notice and may not be as described herein. Please contact ClimateMaster's Customer Service Department at 1-405-745-6000 for specific information on the current design and specifications. Statements and other information contained herein are not express warranties and do not form the basis of any bargain between the parties, but are merely ClimateMaster's opinion or commendation of its products. The latest version of this document is available at climatemaster.com. © ClimateMaster, Inc. All rights reserved 2010

Blower Performance Data – TRE096

Airflow in CFM with wet coil and clean air filter

SCFM	ESP	0.00	0.10	0.20	0.30	0.40	0.50	0.60	0.70	0.80	0.90	1.00	1.10	1.20	1.30	1.40	1.50	1.60	1.70	1.80	1.90	2.00	
2400	BHP	0.36	0.39	0.42	0.46	0.52	0.60	0.67	0.70	0.74	0.77	0.82	0.88	0.95	1.01	1.07	1.13	1.18	1.22	1.27	1.32	1.37	
	Sheave/Mtr	B	B	B	B	A	A	A	A	A	A	A	A	A	C	C	C	C	C	C	C	C	C
	RPM	500	525	563	596	632	668	704	728	756	780	808	832	856	880	904	928	948	968	988	1008	1028	
	Turns Open	6.0	5.0	4.0	3.0	6.0	5.0	4.5	4.0	3.5	2.5	2.0	1.5	1.0	6.0	5.5	5.0	4.5	4.5	4.0	4.0	3.5	
2500	BHP	0.40	0.45	0.50	0.56	0.62	0.67	0.72	0.76	0.80	0.85	0.90	0.97	1.05	1.12	1.18	1.22	1.26	1.31	1.36	1.40	1.46	
	Sheave/Mtr	B	B	B	B	A	A	A	A	A	A	A	A	A	C	C	C	C	C	C	C	C	C
	RPM	504	538	575	612	648	680	712	740	764	792	816	840	868	892	916	936	956	976	1000	1016	1036	
	Turns Open	5.5	4.5	3.5	3.0	5.5	5.0	4.5	3.5	3.0	2.5	2.0	1.5	1.0	5.5	5.0	5.0	4.5	4.0	4.0	3.5	3.5	
2600	BHP	0.47	0.51	0.55	0.60	0.67	0.73	0.78	0.84	0.89	0.94	1.00	1.05	1.11	1.16	1.23	1.28	1.35	1.41	1.46	1.51	1.56	
	Sheave/Mtr	B	B	B	A	A	A	A	A	A	A	A	A	C	C	C	C	C	C	C	C	C	C
	RPM	521	554	592	624	660	692	720	748	776	800	828	852	876	900	924	944	968	988	1008	1028	1048	
	Turns Open	5.5	4.5	3.5	6.0	5.5	4.5	4.0	3.5	2.5	2.0	1.5	1.0	6.0	5.5	5.0	4.5	4.0	4.0	3.5	3.5	3.0	
2700	BHP	0.51	0.56	0.61	0.66	0.72	0.77	0.82	0.88	0.94	0.99	1.06	1.14	1.21	1.27	1.32	1.39	1.44	1.50	1.55	1.59	1.65	
	Sheave/Mtr	B	B	B	A	A	A	A	A	A	A	A	A	C	C	C	C	C	C	C	C	C	C
	RPM	538	571	608	640	672	704	732	760	788	812	836	864	888	912	932	956	976	1000	1020	1036	1056	
	Turns Open	5.0	4.0	3.0	5.5	5.0	4.0	3.5	3.0	2.5	2.0	1.5	1.0	5.5	5.0	4.5	4.5	4.0	3.5	3.5	3.0	3.0	
2800	BHP	0.57	0.62	0.67	0.72	0.77	0.83	0.90	0.96	1.03	1.08	1.15	1.20	1.25	1.33	1.40	1.48	1.56	1.62	1.67	1.71	1.75	
	Sheave/Mtr	B	B	B	A	A	A	A	A	A	A	A	C	C	C	C	C	C	C	C	C	C	C
	RPM	550	583	616	648	684	712	740	768	796	820	848	872	896	920	940	964	988	1008	1028	1044	1064	
	Turns Open	4.5	3.5	2.5	5.5	5.0	4.0	3.5	3.0	2.5	2.0	1.5	6.0	5.5	5.0	4.5	4.0	4.0	3.5	3.0	3.0	2.5	
2900	BHP	0.62	0.66	0.72	0.78	0.83	0.89	0.95	1.02	1.08	1.15	1.22	1.30	1.37	1.44	1.51	1.58	1.66	1.70	1.75	1.79	1.84	
	Sheave/Mtr	B	B	A	A	A	A	A	A	A	A	A	C	C	C	C	C	C	C	C	C	C	C
	RPM	567	600	632	664	696	724	752	780	808	832	856	884	908	932	952	976	1000	1016	1036	1056	1076	
	Turns Open	4.0	3.0	5.5	5.0	4.5	3.5	3.0	2.5	2.0	1.5	1.0	5.5	5.0	4.5	4.5	4.0	3.5	3.5	3.0	3.0	2.5	
3000	BHP	0.68	0.73	0.78	0.83	0.89	0.97	1.05	1.13	1.18	1.24	1.30	1.35	1.42	1.51	1.60	1.68	1.76	1.80	1.85	1.88	1.92	
	Sheave/Mtr	B	B	A	A	A	A	A	A	A	A	C	C	C	C	C	C	C	C	C	C	C	C
	RPM	583	616	648	680	712	740	768	796	820	844	872	896	916	940	964	984	1008	1028	1048	1064	1084	
	Turns Open	3.5	2.5	5.5	5.0	4.0	3.5	3.0	2.5	1.5	1.5	6.0	5.5	5.0	4.5	4.0	4.0	3.5	3.0	3.0	2.5	2.5	
3100	BHP	0.75	0.81	0.88	0.93	1.00	1.05	1.12	1.18	1.25	1.32	1.38	1.45	1.53	1.61	1.67	1.75	1.80	1.86	1.92	2.00	2.03	
	Sheave/Mtr	B	A	A	A	A	A	A	A	A	A	C	C	C	C	C	C	C	C	C	E	E	E
	RPM	604	636	668	696	728	752	780	808	832	856	880	904	928	952	972	996	1016	1036	1056	1076	1096	
	Turns Open	3.0	6.0	5.0	4.5	4.0	3.0	2.5	2.0	1.5	1.0	5.5	5.0	5.0	4.5	4.0	3.5	3.5	3.0	2.5	2.5	2.0	
3200	BHP	0.80	0.86	0.93	0.99	1.07	1.15	1.23	1.28	1.34	1.39	1.44	1.52	1.61	1.69	1.78	1.86	1.91	1.96	2.01	2.06	2.12	
	Sheave/Mtr	B	A	A	A	A	A	A	A	A	C	C	C	C	C	C	C	C	C	E	E	E	E
	RPM	620	652	684	712	740	768	796	820	844	868	892	916	940	960	984	1008	1028	1048	1064	1084	1104	
	Turns Open	2.5	5.5	5.0	4.0	3.5	3.0	2.5	2.0	1.0	6.0	5.5	5.0	4.5	4.0	4.0	3.5	3.0	3.0	2.5	2.5	2.0	
3300	BHP	0.89	0.96	1.03	1.09	1.15	1.22	1.27	1.35	1.42	1.48	1.55	1.63	1.71	1.80	1.87	1.95	2.01	2.07	2.13	2.19	2.25	
	Sheave/Mtr	A	A	A	A	A	A	A	A	A	C	C	C	C	C	C	C	E	E	E	E	E	E
	RPM	636	668	696	724	752	780	804	832	856	880	904	924	948	972	992	1016	1036	1056	1076	1096	1112	
	Turns Open	6.0	5.0	4.5	4.0	3.5	2.5	2.0	1.5	1.0	5.5	5.0	5.0	4.5	4.0	3.5	3.5	3.0	2.5	2.5	2.0	2.0	

A = Standard RPM/Standard Motor, B = Low RPM/Standard Motor, C = High RPM/Standard Motor, D = Standard RPM/Large Motor, E = High RPM/Large Motor
 Unit shipped with standard drive package with drive sheave 2.5 turns open unless otherwise requested. Field adjustment may be required for specified CFM.
 ISO/AHRI rating point with standard drive package and drive sheave open 3.0 turns @ .30 ESP.
 Performance data does not include drive losses and is based on sea level conditions.
 Operation in black areas not permitted.
 All airflow is rated at lowest voltage if unit is dual rated, i.e. rated at 208 volts for 208-230 volt units.

Table Continued on Next Page

Blower Performance Data – TRE096

Table Continued from Previous Page

Airflow in CFM with wet coil and clean air filter

SCFM	ESP	0.00	0.10	0.20	0.30	0.40	0.50	0.60	0.70	0.80	0.90	1.00	1.10	1.20	1.30	1.40	1.50	1.60	1.70	1.80	1.90	2.00	
3400	BHP	0.95	1.02	1.09	1.17	1.24	1.32	1.38	1.43	1.48	1.53	1.61	1.70	1.80	1.88	2.00	2.04	2.11	2.18	2.25	2.32	2.38	
	Sheave/Mtr	A	A	A	A	A	A	A	A	C	C	C	C	C	C	E	E	E	E	E	E	E	E
	RPM	652	684	712	740	764	792	816	840	864	888	912	936	960	980	1004	1024	1044	1064	1084	1104	1120	
	Turns Open	5.5	4.5	4.0	3.5	3.0	2.5	2.0	1.5	6.0	5.5	5.0	4.5	4.5	4.0	3.5	3.0	3.0	2.5	2.5	2.0	1.5	
3500	BHP	1.05	1.13	1.19	1.25	1.31	1.37	1.44	1.51	1.57	1.64	1.74	1.82	1.91	2.01	2.08	2.14	2.21	2.27	2.33	2.41	2.48	
	Sheave/Mtr	A	A	A	A	A	A	A	A	C	C	C	C	C	E	E	E	E	E	E	E	E	E
	RPM	668	696	724	752	776	804	828	852	876	900	924	944	968	992	1012	1032	1052	1072	1092	1112	1128	
	Turns Open	5.0	4.5	4.0	3.5	3.0	2.0	1.5	1.0	5.5	5.0	5.0	4.5	4.0	3.5	3.5	3.0	3.0	2.5	2.0	2.0	1.5	
3600	BHP	1.12	1.18	1.26	1.34	1.41	1.48	1.54	1.61	1.67	1.73	1.82	1.90	1.97	2.06	2.14	2.21	2.29	2.36	2.44	2.53	2.61	
	Sheave/Mtr	A	A	A	A	A	A	A	C	C	C	C	C	C	E	E	E	E	E	E	E	E	E
	RPM	680	708	736	764	788	816	840	864	888	908	932	956	976	1000	1020	1040	1060	1080	1100	1120	1136	
	Turns Open	5.0	4.0	3.5	3.0	2.5	2.0	1.5	6.0	5.5	5.0	4.5	4.5	4.0	3.5	3.5	3.0	2.5	2.5	2.0	1.5	1.5	
3700	BHP	1.23	1.29	1.35	1.41	1.47	1.56	1.64	1.70	1.79	1.87	2.00	2.02	2.10	2.17	2.24	2.31	2.38	2.46	2.54	2.64	2.72	
	Sheave/Mtr	A	A	A	A	A	A	A	C	C	C	E	E	E	E	E	E	E	E	E	E	E	E
	RPM	696	724	752	776	804	828	852	872	896	920	944	964	988	1008	1028	1048	1068	1088	1108	1128	1144	
	Turns Open	4.5	4.0	3.5	3.0	2.0	1.5	1.0	5.5	5.0	5.0	4.5	4.5	4.0	3.5	3.0	3.0	2.5	2.5	2.0	1.5	1.5	
3800	BHP	1.29	1.37	1.44	1.52	1.59	1.67	1.74	1.82	1.89	2.00	2.04	2.12	2.20	2.28	2.36	2.44	2.52	2.60	2.67	2.77	2.84	
	Sheave/Mtr	A	A	A	A	A	A	C	C	C	E	E	E	E	E	E	E	E	E	E	E	E	E
	RPM	712	740	764	792	816	840	864	888	908	932	952	976	1000	1020	1040	1060	1080	1100	1116	1136	1152	
	Turns Open	4.0	3.5	3.0	2.5	2.0	1.5	6.0	5.5	5.0	4.5	4.5	4.0	3.5	3.0	3.0	2.5	2.5	2.0	2.0	1.5	1.0	
3900	BHP	1.41	1.48	1.54	1.61	1.70	1.78	1.84	1.93	2.01	2.08	2.17	2.26	2.33	2.41	2.49	2.57	2.65	2.74	2.81	2.89		
	Sheave/Mtr	A	A	A	A	A	A	C	C	E	E	E	E	E	E	E	E	E	E	E	E	E	E
	RPM	728	752	776	804	828	852	872	896	920	940	964	988	1008	1028	1048	1068	1088	1108	1124	1144		
	Turns Open	4.0	3.0	2.5	2.0	1.5	1.0	5.5	5.5	5.0	4.5	4.0	4.0	3.5	3.0	3.0	2.5	2.0	2.0	1.5	1.0		
4000	BHP	1.48	1.56	1.64	1.71	1.80	1.88	2.00	2.03	2.12	2.19	2.27	2.35	2.43	2.52	2.61	2.69	2.78	2.86	2.93			
	Sheave/Mtr	A	A	A	A	A	C	E	E	E	E	E	E	E	E	E	D	E	E	E			
	RPM	740	768	792	816	840	864	888	908	932	952	976	996	1016	1036	1056	1076	1096	1116	1132			
	Turns Open	3.5	3.0	2.5	2.0	1.5	6.0	5.5	5.0	4.5	4.5	4.0	3.5	3.5	3.0	2.5	2.5	2.0	2.0	1.5			

A = Standard RPM/Standard Motor, B = Low RPM/Standard Motor, C = High RPM/Standard Motor, D = Standard RPM/Large Motor, E = High RPM/Large Motor
 Unit shipped with standard drive package with drive sheave 2.5 turns open unless otherwise requested. Field adjustment may be required for specified CFM.
 ISO/AHRI rating point with standard drive package and drive sheave open 3.0 turns @ .30 ESP
 Performance data does not include drive losses and is based on sea level conditions.
 Operation in black areas not permitted.
 All airflow is rated at lowest voltage if unit is dual rated, i.e. rated at 208 volts for 208-230 volt units.

Blower Performance Data – TRE120

Airflow in CFM with wet coil and clean air filter

SCFM	ESP	0.00	0.10	0.20	0.30	0.40	0.50	0.60	0.70	0.80	0.90	1.00	1.10	1.20	1.30	1.40	1.50	1.60	1.70	1.80	1.90	2.00	
3000	BHP	0.66	0.71	0.76	0.81	0.86	0.94	1.02	1.10	1.17	1.22	1.27	1.32	1.39	1.48	1.56	1.65	1.74	1.78	1.83	1.86	1.91	
	Sheave/Mtr	B	B	B	B	B	A	A	A	A	A	A	A	A	A	A	C	C	C	C	C	C	C
	RPM	571	604	636	668	700	728	756	784	812	836	860	884	908	932	952	976	1000	1020	1040	1056	1076	
	Turns Open	5.5	5.0	4.0	3.0	2.0	6.0	5.5	5.0	4.0	3.5	3.0	2.5	2.0	1.5	1.0	4.5	4.0	4.0	3.5	3.0	3.0	
3100	BHP	0.73	0.79	0.85	0.91	0.98	1.04	1.10	1.16	1.23	1.29	1.36	1.43	1.50	1.58	1.64	1.72	1.78	1.84	1.89	1.95	2.01	
	Sheave/Mtr	B	B	B	B	A	A	A	A	A	A	A	A	A	A	C	C	C	C	C	C	C	C
	RPM	592	624	656	684	716	744	772	800	824	848	872	896	920	944	964	988	1008	1028	1048	1068	1088	
	Turns Open	5.0	4.5	3.5	2.5	6.0	5.5	4.5	4.0	3.5	3.0	2.5	2.0	1.5	1.0	5.0	4.5	4.0	3.5	3.5	3.0	2.5	
3200	BHP	0.78	0.84	0.90	0.97	1.04	1.12	1.20	1.27	1.32	1.37	1.42	1.49	1.58	1.66	1.75	1.84	1.89	1.94	2.00	2.05	2.10	
	Sheave/Mtr	B	B	B	B	A	A	A	A	A	A	A	A	A	A	C	C	C	C	C	C	C	C
	RPM	608	640	672	704	728	756	784	812	836	860	884	908	932	952	976	1000	1020	1040	1060	1080	1100	
	Turns Open	4.5	4.0	3.0	2.0	5.5	5.0	4.5	4.0	3.5	3.0	2.5	2.0	1.5	1.0	4.5	4.0	4.0	3.5	3.0	3.0	2.5	
3300	BHP	0.87	0.93	1.01	1.08	1.14	1.20	1.26	1.33	1.39	1.46	1.53	1.61	1.68	1.77	1.86	1.92	1.98	2.04	2.10	2.16	2.23	
	Sheave/Mtr	B	B	B	B	A	A	A	A	A	A	A	A	A	C	C	C	C	C	C	C	C	C
	RPM	628	656	688	716	744	772	800	824	848	872	896	920	940	964	988	1008	1028	1048	1068	1088	1108	
	Turns Open	4.0	3.5	2.5	1.5	5.5	4.5	4.0	3.5	3.0	2.5	2.0	1.5	1.0	5.0	4.5	4.0	3.5	3.5	3.0	2.5	2.5	
3400	BHP	0.94	1.01	1.07	1.15	1.23	1.30	1.37	1.42	1.47	1.52	1.59	1.69	1.77	1.86	1.96	2.03	2.10	2.16	2.23	2.30	2.36	
	Sheave/Mtr	B	B	B	A	A	A	A	A	A	A	A	A	A	C	C	C	C	C	C	C	C	C
	RPM	644	676	704	732	760	784	812	836	860	884	908	932	952	976	1000	1020	1040	1060	1080	1100	1116	
	Turns Open	3.5	3.0	2.0	5.5	5.0	4.5	4.0	3.5	3.0	2.5	2.0	1.5	1.0	4.5	4.0	4.0	3.5	3.0	3.0	2.5	2.0	
3500	BHP	1.03	1.12	1.18	1.24	1.30	1.36	1.43	1.49	1.56	1.63	1.72	1.80	1.90	1.99	2.07	2.13	2.19	2.26	2.32	2.40	2.47	
	Sheave/Mtr	B	B	A	A	A	A	A	A	A	A	A	A	C	C	C	C	C	C	C	C	C	C
	RPM	660	692	720	744	772	800	824	848	872	896	920	940	964	988	1008	1028	1048	1068	1088	1108	1124	
	Turns Open	3.5	2.5	6.0	5.5	4.5	4.0	3.5	3.0	2.5	2.0	1.5	1.0	5.0	4.5	4.0	3.5	3.5	3.0	2.5	2.5	2.0	
3600	BHP	1.11	1.17	1.25	1.33	1.40	1.47	1.53	1.60	1.66	1.73	1.80	1.89	1.97	2.05	2.12	2.20	2.27	2.35	2.42	2.51	2.59	
	Sheave/Mtr	B	B	A	A	A	A	A	A	A	A	A	A	C	C	C	C	C	C	C	C	C	C
	RPM	676	704	732	760	784	812	836	860	884	908	928	952	976	996	1016	1036	1056	1076	1096	1116	1132	
	Turns Open	3.0	2.0	5.5	5.0	4.5	4.0	3.5	3.0	2.5	2.0	1.5	1.0	4.5	4.0	4.0	3.5	3.0	3.0	2.5	2.0	2.0	
3700	BHP	1.22	1.28	1.35	1.40	1.46	1.54	1.62	1.70	1.77	1.85	1.94	2.00	2.09	2.17	2.24	2.31	2.38	2.46	2.52	2.62	2.72	
	Sheave/Mtr	B	A	A	A	A	A	A	A	A	A	A	C	C	C	C	C	C	C	C	C	C	C
	RPM	692	720	748	772	800	824	848	872	892	916	940	960	984	1008	1028	1048	1068	1088	1104	1124	1144	
	Turns Open	2.5	6.0	5.0	4.5	4.0	3.5	3.0	2.5	2.0	1.5	1.0	5.0	4.5	4.0	3.5	3.5	3.0	2.5	2.5	2.0	1.5	
3800	BHP	1.28	1.35	1.43	1.51	1.58	1.66	1.73	1.81	1.87	1.96	2.04	2.10	2.19	2.26	2.34	2.42	2.50	2.58	2.66	2.75	2.84	
	Sheave/Mtr	B	A	A	A	A	A	A	A	A	A	A	C	C	C	C	C	C	C	C	C	C	C
	RPM	708	732	760	788	812	836	860	884	904	928	952	972	996	1016	1036	1056	1076	1096	1112	1132	1152	
	Turns Open	2.0	5.5	5.0	4.5	4.0	3.5	3.0	2.5	2.0	1.5	1.0	4.5	4.0	4.0	3.5	3.0	3.0	2.5	2.0	2.0	1.5	
3900	BHP	1.39	1.46	1.53	1.60	1.68	1.76	1.83	1.91	2.00	2.08	2.16	2.24	2.32	2.40	2.48	2.56	2.64	2.72	2.81	2.88	3.00	
	Sheave/Mtr	A	A	A	A	A	A	A	A	A	A	C	C	C	C	C	C	C	C	C	C	C	E
	RPM	720	748	772	800	824	848	868	892	916	940	960	984	1004	1024	1044	1064	1084	1104	1124	1140	1160	
	Turns Open	5.5	5.0	4.5	4.0	3.5	3.0	2.5	2.0	1.5	1.0	5.0	4.5	4.0	3.5	3.5	3.0	2.5	2.5	2.0	2.0	1.5	

A = Standard RPM/Standard Motor, B = Low RPM/Standard Motor, C = High RPM/Standard Motor, D = Standard RPM/Large Motor, E = High RPM/Large Motor
 Unit shipped with standard drive package with drive sheave 2.5 turns open unless otherwise requested. Field adjustment may be required for specified CFM.
 ISO/AHRI rating point with standard drive package and drive sheave open 3.0 turns @ .30 ESP.
 Performance data does not include drive losses and is based on sea level conditions.
 Operation in black areas not permitted.
 All airflow is rated at lowest voltage if unit is dual rated, i.e. rated at 208 volts for 208-230 volt units.

Table Continued on Next Page

Blower Performance Data – TRE120

Table Continued from Previous Page

Airflow in CFM with wet coil and clean air filter

SCFM	ESP	0.00	0.10	0.20	0.30	0.40	0.50	0.60	0.70	0.80	0.90	1.00	1.10	1.20	1.30	1.40	1.50	1.60	1.70	1.80	1.90	2.00
4000	BHP	1.47	1.54	1.62	1.70	1.78	1.86	1.95	2.01	2.10	2.17	2.26	2.33	2.41	2.50	2.59	2.68	2.76	2.85	2.93	3.00	3.07
	Sheave/Mtr	A	A	A	A	A	A	A	A	A	A	C	C	C	C	C	C	C	C	C	E	E
	RPM	736	760	788	812	836	860	884	904	928	948	972	992	1012	1032	1052	1072	1092	1112	1132	1148	1168
	Turns Open	5.5	5.0	4.5	4.0	3.5	3.0	2.5	2.0	1.5	1.0	4.5	4.5	4.0	3.5	3.5	3.0	2.5	2.0	2.0	1.5	1.5
4100	BHP	1.56	1.66	1.74	1.82	1.89	1.97	2.03	2.12	2.20	2.29	2.36	2.46	2.53	2.62	2.72	2.81	2.90	3.00	3.06	3.12	3.20
	Sheave/Mtr	A	A	A	A	A	A	A	A	A	C	C	C	C	C	C	C	C	E	E	E	E
	RPM	748	776	800	824	848	872	892	916	936	960	980	1004	1020	1040	1060	1080	1100	1120	1140	1156	1176
	Turns Open	5.0	4.5	4.0	3.5	3.0	2.5	2.0	1.5	1.0	5.0	4.5	4.0	4.0	3.5	3.0	3.0	2.5	2.0	2.0	1.5	1.0
4200	BHP	1.64	1.72	1.81	1.90	1.97	2.06	2.15	2.23	2.31	2.38	2.46	2.56	2.66	2.76	2.86	3.00	3.03	3.11	3.18	3.26	3.34
	Sheave/Mtr	A	A	A	A	A	A	A	A	A	C	C	C	C	C	C	E	E	E	E	E	E
	RPM	764	788	812	836	856	880	904	924	948	968	988	1012	1032	1052	1072	1088	1108	1128	1144	1164	1184
	Turns Open	5.0	4.5	4.0	3.5	3.0	2.5	2.0	1.5	1.0	4.5	4.5	4.0	3.5	3.5	3.0	2.5	2.5	2.0	1.5	1.5	1.0
4300	BHP	1.76	1.84	1.93	2.00	2.08	2.17	2.25	2.34	2.42	2.50	2.60	2.70	2.80	2.90	3.00	3.10	3.16	3.24	3.31	3.39	3.45
	Sheave/Mtr	A	A	A	A	A	A	A	A	C	C	C	C	C	C	E	E	E	E	E	E	E
	RPM	776	800	824	844	868	892	912	936	956	976	1000	1020	1040	1060	1080	1100	1116	1136	1152	1172	1188
	Turns Open	4.5	4.0	3.5	3.0	2.5	2.0	1.5	1.0	5.0	4.5	4.0	4.0	3.5	3.0	3.0	2.5	2.0	2.0	1.5	1.0	1.0
4400	BHP	1.86	1.95	2.04	2.12	2.22	2.32	2.40	2.48	2.57	2.65	2.74	2.84	3.00	3.04	3.14	3.23	3.30	3.38	3.44	3.52	3.58
	Sheave/Mtr	A	A	A	A	A	A	A	A	C	C	C	C	E	E	E	E	E	E	E	E	E
	RPM	788	812	836	856	880	904	924	944	968	988	1008	1028	1048	1068	1088	1108	1124	1144	1160	1180	1196
	Turns Open	4.5	4.0	3.5	3.0	2.5	2.0	1.5	1.0	4.5	4.5	4.0	3.5	3.5	3.0	2.5	2.5	2.0	1.5	1.5	1.0	1.0
4500	BHP	1.96	2.06	2.15	2.23	2.33	2.43	2.52	2.61	2.69	2.78	2.88	3.00	3.08	3.18	3.28	3.35	3.44	3.53	3.61	3.70	
	Sheave/Mtr	A	A	A	A	A	A	A	C	C	C	C	E	E	E	E	E	E	E	E	E	E
	RPM	800	824	848	868	892	916	936	956	976	996	1016	1036	1056	1076	1096	1112	1132	1152	1168	1188	
	Turns Open	4.0	3.5	3.0	2.5	2.0	1.5	1.0	5.0	4.5	4.0	4.0	3.5	3.0	3.0	2.5	2.0	2.0	1.5	1.5	1.0	
4600	BHP	2.12	2.20	2.30	2.38	2.47	2.56	2.64	2.73	2.83	2.92	3.00	3.10	3.20	3.30	3.40	3.49	3.60	3.68	3.79	3.88	
	Sheave/Mtr	A	A	A	A	A	A	A	C	C	C	E	E	E	E	E	E	E	E	E	E	E
	RPM	820	840	864	884	908	928	948	968	992	1012	1028	1048	1068	1088	1108	1124	1144	1160	1180	1196	
	Turns Open	3.5	3.0	3.0	2.5	2.0	1.5	1.0	4.5	4.5	4.0	3.5	3.5	3.0	2.5	2.5	2.0	1.5	1.5	1.0	1.0	
4700	BHP	2.23	2.31	2.40	2.50	2.59	2.68	2.76	2.85	3.00	3.04	3.14	3.24	3.34	3.42	3.53	3.62	3.73	3.84	3.93		
	Sheave/Mtr	A	A	A	A	A	A	C	C	E	E	E	E	E	E	E	E	E	E	E	E	E
	RPM	832	852	876	900	920	940	960	980	1000	1020	1040	1060	1080	1096	1116	1132	1152	1172	1188		
	Turns Open	3.5	3.0	2.5	2.0	1.5	1.0	5.0	4.5	4.0	4.0	3.5	3.0	3.0	2.5	2.0	2.0	1.5	1.0	1.0		
4800	BHP	2.35	2.46	2.55	2.65	2.73	2.81	2.89	3.00	3.06	3.16	3.26	3.34	3.44	3.55	3.64	3.76	3.86	3.98	4.08		
	Sheave/Mtr	A	A	A	A	A	C	C	E	E	E	E	E	E	E	E	E	E	E	E	E	E
	RPM	844	868	888	912	932	952	972	992	1012	1032	1052	1068	1088	1108	1124	1144	1160	1180	1196		
	Turns Open	3.0	2.5	2.0	1.5	1.5	5.0	4.5	4.5	4.0	3.5	3.5	3.0	2.5	2.5	2.0	1.5	1.5	1.0	1.0		
4900	BHP	2.49	2.58	2.68	2.77	2.85	3.00	3.03	3.12	3.22	3.30	3.40	3.50	3.60	3.70	3.82	3.91	4.03	4.13			
	Sheave/Mtr	A	A	A	A	A	E	E	E	E	E	E	E	E	E	E	E	E	E	E	E	E
	RPM	860	880	904	924	944	964	984	1004	1024	1040	1060	1080	1100	1116	1136	1152	1172	1188			
	Turns Open	3.0	2.5	2.0	1.5	1.0	5.0	4.5	4.0	3.5	3.5	3.0	3.0	2.5	2.0	2.0	1.5	1.0	1.0			
5000	BHP	2.63	2.72	2.81	2.91	3.00	3.09	3.18	3.28	3.36	3.46	3.56	3.66	3.75	3.87	3.96	4.08	4.18	4.28			
	Sheave/Mtr	A	A	A	A	E	E	E	E	E	E	E	E	E	E	E	E	E	E	E	E	E
	RPM	876	896	916	936	956	976	996	1016	1032	1052	1072	1092	1108	1128	1144	1164	1180	1196			
	Turns Open	2.5	2.0	1.5	1.0	5.0	4.5	4.0	4.0	3.5	3.5	3.0	2.5	2.5	2.0	1.5	1.5	1.0	1.0			

A = Standard RPM/Standard Motor, B = Low RPM/Standard Motor, C = High RPM/Standard Motor, D = Standard RPM/Large Motor, E = High RPM/Large Motor
 Unit shipped with standard drive package with drive sheave 2.5 turns open unless otherwise requested. Field adjustment may be required for specified CFM.
 ISO/AHRI rating point with standard drive package and drive sheave open 3.0 turns @ .30 ESP.

Performance data does not include drive losses and is based on sea level conditions. Operation in black areas not permitted.

All airflow is rated at lowest voltage if unit is dual rated, i.e. rated at 208 volts for 208-230 volt units.

ClimateMaster works continually to improve its products. As a result, the design and specifications of each product at the time of order may be changed without notice and may not be as described herein. Please contact ClimateMaster's Customer Service Department at 1-405-745-6000 for specific information on the current design and specifications. Statements and other information contained herein are not express warranties and do not form the basis of any bargain between the parties, but are merely ClimateMaster's opinion or commendation of its products. The latest version of this document is available at climatemaster.com. © ClimateMaster, Inc. All rights reserved 2010

Blower Performance Data – TRE144

Airflow in CFM with wet coil and clean air filter

SCFM	ESP	0.00	0.10	0.20	0.30	0.40	0.50	0.60	0.70	0.80	0.90	1.00	1.10	1.20	1.30	1.40	1.50	1.60	1.70	1.80	1.90	2.00	
3600	BHP	0.86	0.93	1.01	1.10	1.18	1.26	1.36	1.46	1.57	1.68	1.77	1.86	1.94	2.03	2.14	2.27	2.38	2.52	2.70	2.86	3.04	
	Sheave/Mtr	B	B	B	B	B	A	A	A	A	A	A	A	C	C	C	C	C	C	C	C	C	E
	RPM	640	672	704	732	760	788	816	840	868	896	924	952	980	1008	1036	1068	1096	1124	1160	1192	1228	
	Turns Open	5.5	5.0	4.0	3.0	2.0	6.0	5.0	4.5	3.5	3.0	2.0	1.5	6.0	5.5	5.0	4.5	4.0	3.5	3.0	2.5	2.0	
3800	BHP	1.06	1.15	1.24	1.33	1.41	1.51	1.59	1.69	1.77	1.87	1.95	2.03	2.13	2.23	2.36	2.49	2.60	2.74	2.88	3.04	3.18	
	Sheave/Mtr	B	B	B	B	A	A	A	A	A	A	A	A	C	C	C	C	C	C	C	C	E	E
	RPM	672	704	732	760	788	816	840	868	892	920	944	968	996	1020	1048	1076	1100	1128	1156	1188	1216	
	Turns Open	5.0	4.0	3.0	2.0	6.0	5.0	4.5	3.5	3.0	2.0	1.5	1.0	6.0	5.5	5.0	4.0	3.5	3.0	2.5	2.0	2.0	
4000	BHP	1.23	1.31	1.41	1.51	1.61	1.69	1.77	1.87	1.96	2.04	2.13	2.22	2.32	2.44	2.56	2.70	2.81	2.92	3.04	3.16	3.30	
	Sheave/Mtr	B	B	B	A	A	A	A	A	A	A	A	C	C	C	C	C	C	C	E	E	E	
	RPM	708	732	760	788	816	840	864	892	916	940	964	988	1012	1036	1060	1088	1112	1136	1164	1192	1216	
	Turns Open	4.0	3.0	2.0	6.0	5.0	4.5	4.0	3.0	2.5	1.5	1.0	6.0	5.5	5.0	4.5	4.0	3.5	3.0	2.5	2.0	1.5	
4200	BHP	1.25	1.40	1.59	1.71	1.79	1.87	1.97	2.06	2.14	2.24	2.34	2.44	2.55	2.66	2.75	2.86	3.00	3.12	3.25	3.38	3.52	
	Sheave/Mtr	B	B	A	A	A	A	A	A	A	A	C	C	C	C	C	C	E	E	E	E	E	
	RPM	696	736	784	816	840	864	892	916	936	960	984	1008	1032	1056	1076	1100	1124	1148	1172	1196	1220	
	Turns Open	3.5	3.0	6.0	5.0	4.5	4.0	3.0	2.5	2.0	1.0	6.0	5.5	5.0	4.5	4.0	3.5	3.0	2.5	2.0	1.5	1.5	
4400	BHP	1.56	1.69	1.79	1.88	1.96	2.04	2.14	2.24	2.35	2.45	2.54	2.65	2.74	2.85	2.96	3.07	3.20	3.34	3.45	3.59	3.74	
	Sheave/Mtr	B	A	A	A	A	A	A	A	C	C	C	C	C	C	E	E	E	E	E	E	E	
	RPM	752	784	812	836	860	884	908	932	956	980	1000	1024	1044	1068	1092	1112	1136	1160	1180	1204	1228	
	Turns Open	2.5	6.0	5.0	4.5	4.0	3.0	2.5	2.0	1.0	6.0	6.0	5.5	5.0	4.5	4.0	3.5	3.0	2.5	2.0	1.5	1.0	
4600	BHP	1.77	1.88	1.96	2.05	2.13	2.22	2.33	2.42	2.53	2.62	2.75	2.85	3.00	3.11	3.22	3.32	3.44	3.54	3.64	3.78	3.92	
	Sheave/Mtr	B	A	A	A	A	A	A	A	C	C	C	C	E	E	E	E	E	E	E	E	E	
	RPM	780	808	832	856	880	904	928	948	972	992	1016	1036	1060	1084	1104	1124	1148	1168	1188	1212	1232	
	Turns Open	1.5	5.5	4.5	4.0	3.5	2.5	2.0	1.5	1.0	6.0	5.5	5.0	4.5	4.0	3.5	3.0	2.5	2.0	2.0	1.5	1.0	
4800	BHP	1.98	2.08	2.17	2.27	2.37	2.48	2.57	2.67	2.76	2.89	3.00	3.11	3.22	3.33	3.44	3.55	3.68	3.79	3.90	4.04	4.18	
	Sheave/Mtr	A	A	A	A	A	A	A	A	C	C	E	E	E	E	E	E	E	E	E	E	E	
	RPM	808	832	856	880	904	928	948	972	992	1016	1036	1056	1076	1096	1116	1136	1160	1180	1200	1220	1240	
	Turns Open	5.5	4.5	4.0	3.5	2.5	2.0	1.5	1.0	6.0	5.5	5.0	4.5	4.0	3.5	3.5	3.0	2.5	2.0	1.5	1.0	1.0	
5000	BHP	2.18	2.30	2.41	2.52	2.61	2.71	2.80	2.89	3.01	3.12	3.23	3.34	3.46	3.57	3.69	3.81	3.93	4.05	4.18	4.32		
	Sheave/Mtr	A	A	A	A	A	A	A	C	E	E	E	E	E	E	E	E	E	E	E	E		
	RPM	828	856	880	904	924	948	968	988	1012	1032	1052	1072	1092	1112	1132	1152	1172	1192	1212	1232		
	Turns Open	4.5	4.0	3.5	2.5	2.0	1.5	1.0	6.0	5.5	5.0	4.5	4.5	4.0	3.5	3.0	2.5	2.0	1.5	1.5	1.0		
5200	BHP	2.41	2.50	2.60	2.72	2.82	2.94	3.04	3.17	3.29	3.44	3.58	3.70	3.82	3.92	4.01	4.13	4.23	4.33	4.47			
	Sheave/Mtr	A	A	A	A	A	A	E	E	E	E	E	E	E	E	E	E	E	E				
	RPM	852	876	900	924	944	968	988	1012	1032	1056	1080	1100	1120	1136	1152	1172	1188	1204	1224			
	Turns Open	4.0	3.5	2.5	2.0	1.0	1.0	6.0	5.5	5.0	4.5	4.0	4.0	3.0	3.0	2.5	2.0	2.0	1.5	1.0			
5400	BHP	2.64	2.75	2.87	3.00	3.10	3.20	3.30	3.41	3.52	3.63	3.74	3.86	4.00	4.11	4.25	4.39	4.53	4.64	4.78			
	Sheave/Mtr	A	A	A	D	D	E	E	E	E	E	E	E	E	E	E	E	E	E				
	RPM	876	900	924	944	968	988	1008	1028	1048	1068	1088	1108	1128	1144	1164	1184	1204	1220	1240			
	Turns Open	3.5	3.0	2.0	1.5	1.0	6.0	5.5	5.0	5.0	4.5	4.0	3.5	3.0	2.5	2.5	2.0	1.5	1.0	1.0			

A = Standard RPM/Standard Motor, B = Low RPM/Standard Motor, C = High RPM/Standard Motor, D = Standard RPM/Large Motor, E = High RPM/Large Motor
 Unit shipped with standard drive package with drive sheave 2.5 turns open unless otherwise requested. Field adjustment may be required for specified CFM.
 ISO/AHRI rating point with standard drive package and drive sheave open 3.0 turns @ .30 ESP.
 Performance data does not include drive losses and is based on sea level conditions.
 Operation in black areas not permitted.
 All airflow is rated at lowest voltage if unit is dual rated, i.e. rated at 208 volts for 208-230 volt units.

Table Continued on Next Page

Blower Performance Data – TRE144

Table Continued from Previous Page

Airflow in CFM with wet coil and clean air filter

SCFM	ESP	0.00	0.10	0.20	0.30	0.40	0.50	0.60	0.70	0.80	0.90	1.00	1.10	1.20	1.30	1.40	1.50	1.60	1.70	1.80	1.90	2.00	
5600	BHP	2.88	2.98	3.10	3.20	3.32	3.42	3.54	3.66	3.78	3.90	4.03	4.14	4.28	4.42	4.53	4.67	4.78	4.92				
	Sheave/Mtr	A	D	D	D	E	E	E	E	E	E	E	E	E	E	E	E	E	E				
	RPM	896	916	940	960	984	1004	1024	1044	1064	1084	1104	1120	1140	1160	1176	1196	1212	1232				
	Turns Open	3.0	2.5	1.5	1.0	6.0	5.5	5.5	5.0	4.5	4.0	3.5	3.0	3.0	2.5	2.0	1.5	1.5	1.0				
5800	BHP	3.12	3.25	3.36	3.47	3.60	3.72	3.84	3.96	4.08	4.18	4.31	4.45	4.56	4.70	4.84	4.96						
	Sheave/Mtr	D	D	D	E	E	E	E	E	E	E	E	E	E	E	E	E						
	RPM	912	936	956	976	1000	1020	1040	1060	1080	1096	1116	1136	1152	1172	1192	1208						
	Turns Open	2.5	2.0	1.0	6.0	6.0	5.5	5.0	4.5	4.0	4.0	3.5	3.0	2.5	2.0	1.5	1.5						
6000	BHP	3.36	3.49	3.63	3.74	3.86	3.99	4.12	4.25	4.37	4.48	4.62	4.76	4.88									
	Sheave/Mtr	D	D	D	E	E	E	E	E	E	E	E	E	E									
	RPM	928	952	976	996	1016	1036	1056	1076	1096	1112	1132	1152	1168									
	Turns Open	2.0	1.5	1.0	6.0	5.5	5.0	4.5	4.0	3.5	3.5	3.0	2.5	2.0									

A = Standard RPM/Standard Motor, B = Low RPM/Standard Motor, C = High RPM/Standard Motor, D = Standard RPM/Large Motor, E = High RPM/Large Motor
 Unit shipped with standard drive package with drive sheave 2.5 turns open unless otherwise requested. Field adjustment may be required for specified CFM.
 ISO/AHRI rating point with standard drive package and drive sheave open 3.0 turns @ .30 ESP.
 Performance data does not include drive losses and is based on sea level conditions.
 Operation in black areas not permitted.
 All airflow is rated at lowest voltage if unit is dual rated, i.e. rated at 208 volts for 208-230 volt units.

Blower Performance Data – TRE168

Airflow in CFM with wet coil and clean air filter

SCFM	ESP	0.00	0.10	0.20	0.30	0.40	0.50	0.60	0.70	0.80	0.90	1.00	1.10	1.20	1.30	1.40	1.50	1.60	1.70	1.80	1.90	2.00			
4200	BHP					0.83	0.91	0.99	1.06	1.15	1.25	1.35	1.45	1.54	1.64	1.72	1.82	1.91	1.99	2.06	2.14	2.22			
	Sheave/Mtr					B	B	B	A	A	A	A	A	A	A	A	A	C	C	C	C	C	C	C	
	RPM					575	612	644	676	708	736	764	792	816	840	860	884	908	928	944	964	984	996		
	Turns Open					5.5	4.0	3.0	6.0	5.0	4.5	3.5	2.5	2.0	1.5	1.0	5.5	5.0	4.5	4.0	3.5	3.0			
4400	BHP					0.89	0.98	1.08	1.17	1.25	1.34	1.43	1.52	1.63	1.74	1.85	1.94	2.04	2.12	2.20	2.28	2.36			
	Sheave/Mtr					B	B	B	A	A	A	A	A	A	A	C	C	C	C	C	C	C	C		
	RPM					587	620	656	688	716	744	772	800	824	848	872	892	916	936	956	976	996			
	Turns Open					5.0	4.0	2.5	5.5	4.5	4.0	3.0	2.5	2.0	1.0	5.5	5.0	4.5	4.0	4.0	3.5	3.0			
4600	BHP					0.86	0.95	1.06	1.16	1.28	1.36	1.43	1.50	1.60	1.73	1.85	1.98	2.10	2.18	2.26	2.34	2.42	2.50		
	Sheave/Mtr					B	B	B	B	A	A	A	A	A	A	A	C	C	C	C	C	C	C		
	RPM					558	596	632	664	700	728	752	780	808	832	856	880	904	924	944	964	984	1004		
	Turns Open					6.0	4.5	3.5	2.5	5.0	4.5	4.0	3.0	2.0	1.5	1.0	5.5	5.0	4.5	4.0	3.5	3.0	2.5		
4800	BHP					0.93	1.01	1.13	1.24	1.34	1.42	1.49	1.57	1.68	1.81	1.93	2.06	2.18	2.27	2.37	2.47	2.56	2.66		
	Sheave/Mtr					B	B	B	A	A	A	A	A	A	A	C	C	C	C	C	C	C	C		
	RPM					571	604	640	676	708	736	760	788	816	840	864	888	912	932	952	972	992	1012		
	Turns Open					5.5	4.5	3.0	6.0	5.0	4.0	3.5	3.0	2.0	1.5	6.0	5.0	4.5	4.5	4.0	3.5	3.0	2.5		
5000	BHP					1.03	1.13	1.25	1.36	1.45	1.54	1.62	1.71	1.83	1.99	2.12	2.26	2.35	2.46	2.54	2.63	2.72	2.83		
	Sheave/Mtr					B	B	B	A	A	A	A	A	A	A	C	C	C	C	C	C	C	C		
	RPM					583	616	652	688	716	744	768	796	820	848	872	896	916	940	960	980	1000	1020		
	Turns Open					5.0	4.0	2.5	5.5	4.5	4.0	3.5	2.5	2.0	1.0	5.5	5.0	4.5	4.0	3.5	3.0	3.0	2.5		
5200	BHP					1.02	1.11	1.22	1.34	1.47	1.58	1.69	1.78	1.90	2.00	2.13	2.23	2.34	2.45	2.59	2.70	2.84	3.00	3.03	
	Sheave/Mtr					B	B	B	B	A	A	A	A	A	A	A	C	C	C	C	C	C	E	E	
	RPM					558	596	628	660	696	724	752	776	804	828	856	880	904	924	948	968	992	1012	1028	
	Turns Open					6.0	4.5	3.5	2.5	5.5	4.5	4.0	3.0	2.5	1.5	1.0	5.5	5.0	4.5	4.0	3.5	3.0	2.5	2.0	
5400	BHP					1.12	1.21	1.33	1.43	1.54	1.65	1.76	1.86	1.99	2.12	2.26	2.41	2.54	2.65	2.77	2.88	3.00	3.10	3.19	
	Sheave/Mtr					B	B	B	A	A	A	A	A	A	A	C	C	C	C	C	E	E	E		
	RPM					571	604	640	672	704	732	760	784	812	836	860	888	912	932	956	976	1000	1020	1036	
	Turns Open					5.5	4.5	3.0	6.0	5.0	4.5	3.5	3.0	2.0	1.5	1.0	5.0	4.5	4.5	4.0	3.5	3.0	2.5	2.0	
5600	BHP					1.23	1.33	1.43	1.54	1.66	1.79	1.91	2.04	2.17	2.27	2.38	2.50	2.63	2.79	3.00	3.09	3.24	3.32	3.41	
	Sheave/Mtr					B	B	B	A	A	A	A	A	A	A	C	C	C	C	E	E	E	E	E	
	RPM					583	616	648	680	712	740	764	792	820	844	868	896	916	940	964	984	1008	1024	1044	
	Turns Open					5.0	4.0	3.0	5.5	5.0	4.0	3.5	2.5	2.0	1.5	6.0	5.0	4.5	4.0	3.5	3.0	2.5	2.5	2.0	
5800	BHP					1.22	1.31	1.42	1.54	1.65	1.77	1.89	2.01	2.12	2.28	2.41	2.55	2.71	2.83	3.00	3.14	3.27	3.40	3.47	3.57
	Sheave/Mtr					B	B	B	B	A	A	A	A	A	A	A	C	C	C	E	E	E	E	E	E
	RPM					563	596	628	660	692	720	748	776	800	828	852	876	904	924	948	972	992	1016	1032	1052
	Turns Open					5.5	4.5	3.5	2.5	5.5	4.5	4.0	3.0	2.5	1.5	1.0	5.5	5.0	4.5	4.0	3.5	3.0	2.5	2.0	1.5
6000	BHP					1.33	1.43	1.53	1.63	1.74	1.90	2.06	2.21	2.33	2.46	2.56	2.67	2.81	3.00	3.15	3.33	3.48	3.57	3.66	3.74
	Sheave/Mtr					B	B	B	A	A	A	A	A	A	A	A	C	E	E	E	E	E	E	E	E
	RPM					575	608	640	672	704	732	760	788	812	840	864	888	912	932	956	980	1000	1020	1040	1060
	Turns Open					5.5	4.0	3.0	6.0	5.0	4.5	3.5	3.0	2.0	1.5	1.0	5.0	4.5	4.5	4.0	3.5	3.0	2.5	2.0	1.5

A = Standard RPM/Standard Motor, B = Low RPM/Standard Motor, C = High RPM/Standard Motor, D = Standard RPM/Large Motor, E = High RPM/Large Motor
 Unit shipped with standard drive package with drive sheave 2.5 turns open unless otherwise requested. Field adjustment may be required for specified CFM.
 ISO/AHRI rating point with standard drive package and drive sheave open 3.0 turns @ .30 ESP.
 Performance data does not include drive losses and is based on sea level conditions.
 Operation in black areas not permitted.
 All airflow is rated at lowest voltage if unit is dual rated, i.e. rated at 208 volts for 208-230 volt units.

Table Continued on Next Page

Blower Performance Data – TRE168

Table Continued from Previous Page

Airflow in CFM with wet coil and clean air filter

SCFM	ESP	0.00	0.10	0.20	0.30	0.40	0.50	0.60	0.70	0.80	0.90	1.00	1.10	1.20	1.30	1.40	1.50	1.60	1.70	1.80	1.90	2.00
6200	BHP	1.35	1.44	1.56	1.69	1.82	1.95	2.07	2.18	2.30	2.45	2.59	2.72	2.86	3.05	3.14	3.29	3.44	3.56	3.68	3.79	3.90
	Sheave/Mtr	B	B	B	B	A	A	A	A	A	A	A	C	C	E	E	E	E	E	E	E	E
	RPM	558	587	620	652	684	716	744	768	796	824	848	872	896	920	940	964	988	1008	1028	1048	1068
	Turns Open	6.0	5.0	4.0	2.5	5.5	4.5	4.0	3.5	2.5	2.0	1.5	5.5	5.0	4.5	4.0	3.5	3.0	2.5	2.0	2.0	1.5
6400	BHP	1.43	1.54	1.66	1.78	1.90	2.05	2.21	2.37	2.52	2.62	2.73	2.83	2.95	3.13	3.28	3.47	3.65	3.76	3.87	3.97	4.08
	Sheave/Mtr	B	B	B	B	A	A	A	A	A	A	A	C	C	E	E	E	E	E	E	E	E
	RPM	571	604	636	664	696	724	752	780	808	832	856	880	904	928	948	972	996	1016	1036	1056	1076
	Turns Open	5.5	4.5	3.5	2.5	5.5	4.5	4.0	3.0	2.5	1.5	1.0	5.5	5.0	4.5	4.0	3.5	3.0	2.5	2.0	1.5	1.0
6600	BHP	1.55	1.68	1.83	1.96	2.12	2.24	2.36	2.47	2.61	2.74	3.00	3.01	3.17	3.34	3.48	3.66	3.82	3.94	4.06	4.16	4.28
	Sheave/Mtr	B	B	B	A	A	A	A	A	A	A	D	E	E	E	E	E	E	E	E	E	E
	RPM	583	616	648	676	708	736	764	788	816	840	864	888	912	936	956	980	1004	1024	1044	1060	1080
	Turns Open	5.0	4.0	3.0	6.0	5.0	4.0	3.5	3.0	2.0	1.5	1.0	5.0	4.5	4.0	3.5	3.0	2.5	2.5	2.0	1.5	1.0
6800	BHP	1.68	1.80	1.94	2.08	2.23	2.37	2.52	2.68	2.79	3.00	3.07	3.10	3.28	3.47	3.63	3.82	3.97	4.11	4.25	4.38	4.52
	Sheave/Mtr	B	B	B	A	A	A	A	A	A	D	D	E	E	E	E	E	E	E	E	E	E
	RPM	600	628	660	692	720	744	772	800	824	848	872	896	920	944	964	988	1008	1028	1048	1068	1088
	Turns Open	4.5	3.5	2.5	5.5	4.5	4.0	3.0	2.5	2.0	1.0	1.0	5.0	4.5	4.0	3.5	3.0	2.5	2.0	1.5	1.5	1.0
7000	BHP	1.79	1.97	2.12	2.30	2.40	2.53	2.65	2.76	2.90	3.10	3.17	3.31	3.50	3.66	3.86	4.05	4.18	4.31	4.44	4.57	4.69
	Sheave/Mtr	B	B	A	A	A	A	A	A	A	D	E	E	E	E	E	E	E	E	E	E	E
	RPM	612	644	672	704	728	756	784	808	832	856	880	904	928	948	972	996	1016	1036	1056	1076	1096
	Turns Open	4.0	3.0	6.0	5.0	4.5	3.5	3.0	2.5	1.5	1.0	5.5	5.0	4.5	4.0	3.5	3.0	2.5	2.0	1.5	1.0	1.0

A = Standard RPM/Standard Motor, B = Low RPM/Standard Motor, C = High RPM/Standard Motor, D = Standard RPM/Large Motor, E = High RPM/Large Motor

Unit shipped with standard drive package with drive sheave 2.5 turns open unless otherwise requested. Field adjustment may be required for specified CFM.

ISO/AHRI rating point with standard drive package and drive sheave open 3.0 turns @ .30 ESP.

Performance data does not include drive losses and is based on sea level conditions.

Operation in black areas not permitted.

All airflow is rated at lowest voltage if unit is dual rated, i.e. rated at 208 volts for 208-230 volt units.

Blower Performance Data – TRE240

Airflow in CFM with wet coil and clean air filter

SCFM	ESP	0.00	0.10	0.20	0.30	0.40	0.50	0.60	0.70	0.80	0.90	1.00	1.10	1.20	1.30	1.40	1.50	1.60	1.70	1.80	1.90	2.00
6000	BHP		1.50	1.60	1.71	1.85	2.01	2.17	2.32	2.42	2.53	2.63	2.75	2.93	3.12	3.27	3.45	3.55	3.64	3.73	3.81	3.88
	Sheave/Mtr		B	B	B	B	B	A	A	A	A	A	A	A	A	A	A	C	C	C	C	C
	RPM		632	664	696	724	752	780	808	832	856	880	904	928	952	972	996	1016	1036	1056	1076	1092
	Turns Open		6.0	5.5	4.5	3.5	2.5	6.0	5.5	4.5	4.0	3.5	2.5	2.0	1.5	1.0	0.0	5.5	5.0	4.5	4.0	4.0
6200	BHP		1.67	1.80	1.93	2.06	2.18	2.30	2.43	2.57	2.70	2.84	2.98	3.14	3.26	3.42	3.56	3.68	3.77	3.88	3.99	4.11
	Sheave/Mtr		B	B	B	B	B	A	A	A	A	A	A	A	A	A	C	C	C	C	C	C
	RPM		648	680	712	740	768	796	820	844	868	892	916	940	960	984	1008	1028	1044	1064	1084	1104
	Turns Open		5.5	5.0	3.5	3.0	2.0	5.5	5.0	4.5	3.5	3.0	2.5	1.5	1.0	0.5	6.0	5.0	5.0	4.5	4.0	3.5
6400	BHP	1.66	1.79	1.90	2.05	2.21	2.37	2.52	2.62	2.73	2.83	2.95	3.13	3.32	3.47	3.65	3.76	3.87	3.97	4.08	4.18	4.33
	Sheave/Mtr	B	B	B	B	B	A	A	A	A	A	A	A	A	A	A	C	C	C	C	C	C
	RPM	636	668	696	724	752	780	808	832	856	880	904	928	952	972	996	1016	1036	1056	1076	1096	1116
	Turns Open	6.0	5.0	4.5	3.5	2.5	6.0	5.5	4.5	4.0	3.5	2.5	2.0	1.5	1.0	0.0	5.5	5.0	4.5	4.0	3.5	3.5
6600	BHP	1.85	2.00	2.13	2.26	2.38	2.50	2.63	2.77	2.90	3.04	3.20	3.37	3.51	3.68	3.85	3.97	4.09	4.18	4.30	4.43	4.59
	Sheave/Mtr	B	B	B	B	B	A	A	A	A	A	A	A	A	A	C	C	C	C	C	C	C
	RPM	652	684	712	740	768	796	820	844	868	892	916	940	960	984	1008	1028	1048	1064	1084	1104	1124
	Turns Open	5.5	4.5	3.5	3.0	2.0	5.5	5.0	4.5	3.5	3.0	2.5	1.5	1.0	0.5	6.0	5.0	4.5	4.5	4.0	3.5	3.0
6800	BHP	2.00	2.14	2.28	2.43	2.57	2.72	2.82	2.93	3.03	3.15	3.34	3.54	3.70	3.89	4.03	4.16	4.30	4.44	4.57	4.73	4.86
	Sheave/Mtr	B	B	B	B	A	A	A	A	A	A	A	A	A	A	C	C	C	C	C	C	C
	RPM	672	704	728	756	780	808	832	856	880	904	928	952	972	996	1016	1036	1056	1076	1096	1116	1132
	Turns Open	5.0	4.0	3.0	2.5	6.0	5.5	4.5	4.0	3.5	2.5	2.0	1.5	1.0	0.0	5.5	5.0	4.5	4.0	3.5	3.5	3.0
7000	BHP	2.21	2.35	2.47	2.58	2.70	2.83	2.97	3.10	3.24	3.41	3.60	3.76	3.95	4.13	4.26	4.36	4.49	4.62	4.76	5.00	5.07
	Sheave/Mtr	B	B	B	B	A	A	A	A	A	A	A	A	A	C	C	C	C	C	C	E	E
	RPM	688	716	744	768	796	820	844	868	892	916	940	960	984	1008	1028	1044	1064	1084	1104	1124	1140
	Turns Open	4.5	3.5	2.5	2.0	5.5	5.0	4.5	3.5	3.0	2.5	1.5	1.0	0.5	6.0	5.0	5.0	4.5	4.0	3.5	3.0	3.0
7200	BHP	2.34	2.50	2.66	2.79	2.94	3.07	3.17	3.30	3.43	3.60	3.77	3.92	4.09	4.24	4.39	4.55	4.70	4.85	5.03	5.17	5.36
	Sheave/Mtr	B	B	B	A	A	A	A	A	A	A	A	A	A	C	C	C	C	C	E	E	E
	RPM	704	732	760	784	812	836	856	880	904	928	952	972	996	1016	1036	1056	1076	1096	1116	1132	1152
	Turns Open	4.0	3.0	2.0	6.0	5.0	4.5	4.0	3.5	2.5	2.0	1.5	1.0	0.0	5.5	5.0	4.5	4.0	4.0	3.5	3.0	2.5
7400	BHP	2.57	2.69	2.80	2.92	3.08	3.25	3.41	3.57	3.71	3.87	4.04	4.17	4.34	4.48	4.63	4.77	4.91	5.08	5.24	5.44	5.60
	Sheave/Mtr	B	B	B	A	A	A	A	A	A	A	A	A	C	C	C	C	C	E	E	E	E
	RPM	720	748	772	800	824	848	872	896	916	940	964	984	1008	1028	1048	1068	1088	1108	1124	1144	1160
	Turns Open	3.5	2.5	1.5	5.5	5.0	4.0	3.5	3.0	2.5	1.5	1.0	0.5	6.0	5.0	5.0	4.5	4.0	3.5	3.0	2.5	2.5
7600	BHP	2.72	2.88	3.01	3.18	3.31	3.46	3.62	3.77	3.94	4.07	4.24	4.37	4.53	4.69	4.85	5.01	5.17	5.35	5.53	5.68	5.86
	Sheave/Mtr	B	B	A	A	A	A	A	A	A	A	A	A	C	C	C	E	E	E	E	E	E
	RPM	736	764	788	816	836	860	884	908	932	952	976	996	1016	1036	1056	1076	1096	1116	1136	1152	1172
	Turns Open	3.0	2.0	6.0	5.0	4.5	4.0	3.0	2.5	2.0	1.5	0.5	0.0	5.5	5.0	4.5	4.5	4.0	3.5	3.0	2.5	2.0
7800	BHP	2.95	3.10	3.23	3.39	3.55	3.72	3.88	4.02	4.20	4.34	4.51	4.66	4.82	4.98	5.14	5.30	5.47	5.61	5.79	5.96	6.10
	Sheave/Mtr	B	A	A	A	A	A	A	A	A	A	A	C	C	C	E	E	E	E	E	E	E
	RPM	752	780	804	828	852	876	900	920	944	964	988	1008	1028	1048	1068	1088	1108	1124	1144	1164	1180
	Turns Open	2.5	6.0	5.5	4.5	4.0	3.5	3.0	2.0	1.5	1.0	0.5	6.0	5.0	5.0	4.5	4.0	3.5	3.0	2.5	2.5	2.0

A = Standard RPM/Standard Motor, B = Low RPM/Standard Motor, C = High RPM/Standard Motor, D = Standard RPM/Large Motor, E = High RPM/Large Motor
 Unit shipped with standard drive package with drive sheave 2.5 turns open unless otherwise requested. Field adjustment may be required for specified CFM.
 ISO/AHRI rating point with standard drive package and drive sheave open 3.0 turns @ .30 ESP.
 Performance data does not include drive losses and is based on sea level conditions.
 Operation in black areas not permitted.
 All airflow is rated at lowest voltage if unit is dual rated, i.e. rated at 208 volts for 208-230 volt units.

Table Continued on Next Page

Blower Performance Data – TRE240

Table Continued from Previous Page

Airflow in CFM with wet coil and clean air filter

SCFM	ESP	0.00	0.10	0.20	0.30	0.40	0.50	0.60	0.70	0.80	0.90	1.00	1.10	1.20	1.30	1.40	1.50	1.60	1.70	1.80	1.90	2.00
8000	BHP	3.13	3.30	3.46	3.59	3.76	3.92	4.09	4.23	4.40	4.55	4.72	4.90	5.07	5.25	5.42	5.60	5.73	5.89	6.05	6.18	6.34
	Sheave/Mtr	B	A	A	A	A	A	A	A	A	A	A	C	E	E	E	E	E	E	E	E	E
	RPM	768	796	820	840	864	888	912	932	956	976	1000	1020	1040	1060	1080	1100	1116	1136	1156	1172	1192
	Turns Open	2.0	5.5	5.0	4.5	4.0	3.0	2.5	2.0	1.0	0.5	0.0	5.5	5.0	4.5	4.0	3.5	3.5	3.0	2.5	2.0	1.5
8200	BHP	3.37	3.53	3.68	3.84	3.99	4.15	4.30	4.48	4.64	4.79	5.00	5.17	5.36	5.54	5.73	5.86	6.02	6.18	6.31	6.47	6.60
	Sheave/Mtr	A	A	A	A	A	A	A	A	A	A	E	E	E	E	E	E	E	E	E	E	E
	RPM	784	808	832	856	880	904	924	948	968	988	1012	1032	1052	1072	1092	1108	1128	1148	1164	1184	1200
	Turns Open	6.0	5.5	4.5	4.0	3.5	2.5	2.0	1.5	1.0	0.5	5.5	5.0	4.5	4.5	4.0	3.5	3.0	2.5	2.5	2.0	1.5
8400	BHP	3.52	3.70	3.88	4.07	4.22	4.40	4.54	4.71	4.86	5.00	5.20	5.40	5.60	5.80	6.00	6.16	6.32	6.45	6.61	6.74	
	Sheave/Mtr	A	A	A	A	A	A	A	A	A	D	E	E	E	E	E	E	E	E	E	E	
	RPM	800	824	848	872	892	916	936	960	980	1000	1020	1040	1060	1080	1100	1120	1140	1156	1176	1192	
	Turns Open	5.5	5.0	4.0	3.5	3.0	2.5	2.0	1.0	0.5	0.0	5.5	5.0	4.5	4.0	3.5	3.0	3.0	2.5	2.0	1.5	
8600	BHP	3.80	3.97	4.11	4.28	4.46	4.62	4.78	5.00	5.14	5.32	5.52	5.72	5.92	6.12	6.30	6.46	6.58	6.74	6.87		
	Sheave/Mtr	A	A	A	A	A	A	A	D	D	E	E	E	E	E	E	E	E	E	E		
	RPM	816	840	860	884	908	928	948	972	992	1012	1032	1052	1072	1092	1112	1132	1148	1168	1184		
	Turns Open	5.0	4.5	4.0	3.0	2.5	2.0	1.5	1.0	0.0	5.5	5.0	4.5	4.5	4.0	3.5	3.0	2.5	2.0	2.0		
8800	BHP	4.06	4.25	4.41	4.60	4.76	5.00	5.11	5.27	5.44	5.64	5.84	6.04	6.24	6.43	6.56	6.72	6.88	7.01	7.17		
	Sheave/Mtr	A	A	A	A	A	D	D	D	D	E	E	E	E	E	E	E	E	E	E		
	RPM	832	856	876	900	920	944	964	984	1004	1024	1044	1064	1084	1104	1120	1140	1160	1176	1196		
	Turns Open	4.5	4.0	3.5	3.0	2.0	1.5	1.0	0.5	0.0	5.5	5.0	4.5	4.0	3.5	3.0	3.0	2.5	2.0	1.5		
9000	BHP	4.30	4.50	4.66	4.86	5.04	5.21	5.39	5.56	5.76	5.96	6.16	6.36	6.56	6.71	6.89	7.07	7.21	7.39			
	Sheave/Mtr	A	A	A	A	D	D	D	D	E	E	E	E	E	E	E	E	E	E			
	RPM	848	872	892	916	936	956	976	996	1016	1036	1056	1076	1096	1112	1132	1152	1168	1188			
	Turns Open	4.0	3.5	3.0	2.5	2.0	1.0	0.5	0.0	5.5	5.0	4.5	4.0	4.0	3.5	3.0	2.5	2.0	2.0			
9200	BHP	4.62	4.78	5.00	5.15	5.32	5.48	5.65	5.84	6.04	6.24	6.44	6.64	6.81	7.02	7.20	7.41					
	Sheave/Mtr	A	A	D	D	D	D	D	E	E	E	E	E	E	E	E	E					
	RPM	868	888	912	932	952	972	992	1012	1032	1052	1072	1092	1108	1128	1144	1164					
	Turns Open	3.5	3.0	2.5	2.0	1.5	1.0	0.0	5.5	5.0	4.5	4.5	4.0	3.5	3.0	2.5	2.5					
9400	BHP	4.87	5.07	5.25	5.42	5.60	5.77	5.96	6.16	6.36	6.56	6.72	6.92	7.15	7.33							
	Sheave/Mtr	A	D	D	D	D	D	D	E	E	E	E	E	E	E							
	RPM	884	908	928	948	968	988	1008	1028	1048	1068	1084	1104	1124	1140							
	Turns Open	3.0	2.5	2.0	1.5	1.0	0.5	0.0	5.0	5.0	4.5	4.0	3.5	3.0	3.0							
9600	BHP	5.23	5.39	5.55	5.71	5.87	6.04	6.24	6.44	6.64	6.80	7.00	7.24	7.43								
	Sheave/Mtr	D	D	D	D	D	D	E	E	E	E	E	E	E								
	RPM	904	924	944	964	984	1004	1024	1044	1064	1080	1100	1120	1136								
	Turns Open	2.5	2.0	1.5	1.0	0.5	0.0	5.5	5.0	4.5	4.0	3.5	3.0	3.0								
9800	BHP	5.50	5.67	5.85	6.02	6.20	6.40	6.60	6.80	6.96	7.16	7.39										
	Sheave/Mtr	D	D	D	D	D	E	E	E	E	E	E										
	RPM	920	940	960	980	1000	1020	1040	1060	1076	1096	1116										
	Turns Open	2.0	1.5	1.0	0.5	0.0	5.5	5.0	4.5	4.0	4.0	3.5										
10000	BHP	5.85	6.00	6.18	6.36	6.56	6.76	6.96	7.16	7.32												
	Sheave/Mtr	D	D	D	D	E	E	E	E	E												
	RPM	940	956	976	996	1016	1036	1056	1076	1092												
	Turns Open	1.5	1.0	0.5	0.0	5.5	5.0	4.5	4.0	4.0												

A = Standard RPM/Standard Motor, B = Low RPM/Standard Motor, C = High RPM/Standard Motor, D = Standard RPM/Large Motor, E = High RPM/Large Motor
 Unit shipped with standard drive package with drive sheave 2.5 turns open unless otherwise requested. Field adjustment may be required for specified CFM.
 ISO/AHRI rating point with standard drive package and drive sheave open 3.0 turns @ .30 ESP.
 Performance data does not include drive losses and is based on sea level conditions. Operation in black areas not permitted.
 All airflow is rated at lowest voltage if unit is dual rated, i.e. rated at 208 volts for 208-230 volt units.

ClimateMaster works continually to improve its products. As a result, the design and specifications of each product at the time of order may be changed without notice and may not be as described herein. Please contact ClimateMaster's Customer Service Department at 1-405-745-6000 for specific information on the current design and specifications. Statements and other information contained herein are not express warranties and do not form the basis of any bargain between the parties, but are merely ClimateMaster's opinion or commendation of its products. The latest version of this document is available at climatemaster.com. © ClimateMaster, Inc. All rights reserved 2010

Performance Data – Correction Tables

Air Flow Correction Table

Airflow	Cooling				Heating		
	% of Rated	Total Capacity	Sensible Capacity	Power	Heat of Rejection	Heating Capacity	Power
69%	0.976	0.858	0.938	0.968	0.982	1.021	0.972
75%	0.980	0.884	0.950	0.974	0.987	1.018	0.978
81%	0.981	0.907	0.965	0.978	0.991	1.024	0.983
88%	0.991	0.936	0.973	0.987	0.995	1.010	0.991
94%	0.997	0.966	0.986	0.995	1.000	1.005	0.999
100%	1.000	1.000	1.000	1.000	1.000	1.000	1.000
106%	1.004	1.030	1.011	1.006	1.008	0.998	1.011
113%	1.008	1.059	1.022	1.011	1.012	0.997	1.016
119%	1.011	1.079	1.042	1.017	1.018	1.007	1.020
125%	1.018	1.120	1.051	1.024	1.021	0.994	1.028

Entering Air Correction Table - Heating

Heating			
Entering Air DB°F	Heating Capacity	Power	Heat of Extraction
50	1.020	0.950	1.035
55	1.012	0.990	1.017
60	1.007	0.995	1.014
65	1.006	0.997	1.008
68	1.002	0.999	1.003
70	1.000	1.000	1.000
75	0.998	1.006	0.996
80	0.996	1.015	0.991

ClimaDry® II - ESP Loss

Coil Face Velocity FPM	ERE with Reheat - ESP Loss				
	TRE036 & 048 in. of Water	TRE060 & 072 in. of Water	TRE096 in. of Water	TRE120 & 144 in. of Water	TRE168 & 240 in. of Water
175	-	-	-	-	-
200	0.17	0.17	-	-	0.15
225	0.18	0.18	-	-	0.16
250	0.20	0.20	0.19	-	0.18
275	0.21	0.21	0.20	0.20	0.19
300	0.22	0.23	0.22	0.22	0.21
325	0.23	0.24	0.23	0.23	0.22
350	0.25	0.26	0.24	0.25	0.24
375	0.26	0.27	0.25	0.27	0.25
400	0.27	0.29	0.27	0.28	0.26
425	-	0.30	0.28	0.30	0.28
450	-	0.31	0.29	0.32	0.29
475	-	-	-	0.33	0.31
500	-	-	-	0.35	0.32
525	-	-	-	0.37	-
550	-	-	-	0.38	-
575	-	-	-	0.40	-

Wet to Dry Coil Conversion Table

Air Coil Face Velocity	Required BHP Multiplier	Required RPM Multiplier
200	0.956	0.997
250	0.973	0.997
300	0.978	0.997
350	0.981	0.997
400	0.987	0.996
450	0.993	0.996
500	1.069	0.994

Entering Air Correction Table - Cooling

Entering Air WB °F	Total Capacity	Sensible Cooling Capacity Multiplier - Entering Air DB °F									Power	Heat of Rejection
		60	65	70	75	80	80.6	85	90	95		
50	0.727	0.885	*	*	*	*	*	*	*	*	0.976	0.776
55	0.801	0.690	0.889	0.845	*	*	*	*	*	*	0.982	0.837
60	0.880	0.000	0.689	0.887	1.087	*	*	*	*	*	0.989	0.902
65	0.977	0.000	0.000	0.684	0.882	1.084	1.107	1.284	*	*	0.997	0.972
66.2	0.966	0.000	0.000	0.636	0.833	1.034	1.058	1.235	*	*	0.999	0.972
67	1.000	0.000	0.000	0.604	0.800	1.000	1.024	1.202	*	*	1.000	1.000
70	1.044	0.000	0.000	0.000	0.677	0.875	0.899	1.076	1.278	*	1.005	1.044
75	1.144	0.000	0.000	0.000	0.000	0.683	0.683	0.866	1.067	1.269	1.014	1.119

* = Sensible capacity equals total capacity
 AHRI/ISO/ASHRAE 13256-1 uses entering air conditions of Cooling - 80.6°F DB/66.2°F WB, 1 and Heating - 68°F DB/59°F WB entering air temperature

Physical Data

Model	036	048	060	072	096	120	144	168	240
Compressor (qty)	Scroll (1)				Scroll (2)				
Factory Charge HFC-410A - (oz) [kg] per circuit	64 [1.81]	84 [2.38]	120 [3.40]	132 [3.74]	108 [3.06]	120 [3.4]	130 [3.69]	192 [5.44]	300 [8.50]
Blower Motor									
Motor Quantity	1								
Standard Motor (hp) [kW]	1 [.75]	1 [.75]	1 [.75]	1.5 [1.12]	2 [1.49]	3 [2.24]	3 [2.24]	3 [2.24]	5 [3.73]
Large Motor (hp) [kW]	N/A	1.5 [1.12]	1.5 [1.12]	2 [1.49]	3 [2.24]	5 [3.73]	5 [3.73]	5 [3.73]	7.5 [5.60]
Blower(s)									
Number of Blowers	1							2	
Blower Wheel Size (dia x w) - (in) [cm]	10 x 6 [25.4 x 15.2]		12 x 12 [30.5 x 30.5]		15 x 11 [38.1 x 38.1]		15 x 15 [38.1 x 38.1]		15 x 11 [38.1 x 38.1]
V-belt size, Std drive	A29	A30	A32	AX33	B40	BX42	BX46		B39 BX40
Water Connection Size									
FPT (in) [cm]	3/4" [19.05]		1" [25.4]	1-1/4" [31.75]	1-1/2" [38.1]			2" [50.8]	
Coax Volume									
Volume (US Gallons) [liters]	0.61 [2.29]	0.77 [2.90]	1.11 [4.21]	1.30 [4.93]	1.69 [6.49]	2.29 [8.69]	2.68 [10.13]	3.83 [14.50]	4.77 [18.04]
Condensate Connection Size									
FPT (in)	1" [25.4]								
Air Coil Data									
Air Coil Total Face Area (ft ²) [m ²]	5 [.465]		7 [.65]		9.33 [.867]		10.5 [.975]		20 [1.86]
Internal Secondary Pump/ClimaDry® II Pump									
No. of Pumps	1								
Standard Motor (hp) [kW]	1/6 [.124]			1/2 [.373]			3/4 [.556]	1-1/2 [1.12]	
Connection Size (in) [cm]	3/4" [19.05]		1" [25.4]		1-1/2" [38.1]			2" [1.86]	
Hydronic Coil Data									
Air Coil Dimensions H x W (in) [cm]	32 x 20 [81.3 x 50.8]		32 x 28 [81.3 x 71.1]		38 x 32 [96.5 x 81.3]		38 x 36 [96.5 x 91.4]		76 x 36 [193.0 x 91.4]
Air Coil Total Face Area (ft ²) [m ²]	4.44 [.413]		6.22 [.578]		8.44 [.784]		9.5 [.883]		19 [1.77]
Air Coil Tube Size (in) [cm]	3/8 [0.953]								
Air Coil Fin Spacing (fpi) [fins per min]	11 [4.3]								
Air Coil Number of Rows	2								
Miscellaneous Data									
Filter Standard - 2" [50.8mm] MERV8 (qty) (in) [cm]	(QTY.4) 16 x 20 [406 X 508]				(QTY.6) 16 x 20 [406 X 508]			(QTY.8) 16 x 20 [406 X 508] (QTY.2) 20 x 20 [508 X 508]	
Weight - Operating (lbs) [kg]	735 [333]	785 [356]	785 [356]	880 [399]	1080[490]	1125[510]	1175 [533]	1770 [803]	1960 [889]
Weight - Packaged (lbs) [kg]	750 [340]	800 [363]	850 [386]	900 [408]	1100 [499]	1150 [522]	1200 [544]	1800 [816]	2000 [907]
ClimaDry® II Weight - Operating (lbs) [kg]	802 [364]	852 [386]	920 [417]	965 [438]	1223 [556]	1275 [578]	1325 [601]	1978 [897]	2176 [987]
ClimaDry® II Weight - Packaged (lbs) [kg]	817 [371]	867 [393]	935 [324]	985 [447]	1243 [564]	1300 [590]	1350 [612]	1998 [906]	2216 [1005]
Corner Weight - Operating (lbs) [kg]									
Front-Left	184 [83.46]	196 [88.90]	208.5 [94.57]	224 [101.60]	292 [132.45]	303.5 [137.67]	320 [145.15]	479 [217.27]	530 [240.40]
Front-Right	259 [117.48]	276 [125.19]	293.5 [133.13]	298 [135.17]	380 [172.37]	395.5 [179.40]	406 [184.16]	623 [282.59]	690 [312.98]
Rear-Left	108.5 [49.21]	117 [53.07]	124.5 [56.47]	134 [60.78]	193 [87.54]	202 [91.63]	212.5 [96.38]	315 [142.88]	350 [158.76]
Rear-Right	183.5 [83.23]	196 [88.90]	208.5 [94.57]	224 [101.60]	215 [97.52]	224 [101.60]	236.5 [107.27]	353 [160.12]	390 [176.90]
Curb, installed lb [kg]	83 [37.65]				94 [42.64]			128 [58.06]	

TRE Series Nomenclature – ClimaDry® II Option

① TRE 036 D H C 1 A A A S

HEAT EXCHANGER OPTIONS ③ ⑥ ⑦ ⑧

	NON-COATED AIR COILS		COATED AIR COILS	
	COPPER (CU) COAX	CUPRO-NICKEL (CN) COAX	COPPER (CU) COAX	CUPRO-NICKEL (CN) COAX
STANDARD	C	N	A	J
MOTORIZED VALVE	T	S	U	W
CLIMADRY® II	E	P	D	F
INTERNAL SECONDARY PUMP	H	Z	G	Y

NOTE:

- ALL UNITS COME STANDARD WITH DOUBLE ISOLATED COMPRESSOR, STAINLESS STEEL DRAIN PAN, AND 75VA TRANSFORMER.
- REFER TO BLOWER PERFORMANCE TABLES IN SPEC CATALOG TO DETERMINE CORRECT DRIVE PACKAGE
- DIGIT 12 OPTIONS "D", "E", "F", "G", "H", "P", "S", "T", "U", "W", "Y", or "Z" ARE NOT AVAILABLE WITH CXM2.
- DIGIT 13 OPTIONS "G, H & J" ARE NOT AVAILABLE WITH CXM2.
- DIGIT 11 OPTION "D" IS NOT AVAILABLE ON SIZES 036, 072, 096, AND 120. OPTION "E" IS NOT AVAILABLE ON SIZE 036.
- HOT GAS BYPASS ON LEAD CIRCUIT ONLY. HOT GAS BYPASS IS STANDARD WITH CLIMADRY® II OPTION.
- DIGIT 12 AIR COILS ARE REFRIGERANT & HYDRONIC AIR COILS. 2 WAY MOTORIZED ON/OFF VALVE NOT AVAILABLE WITH "D", "E", "F", "G", "H", "P", "Y" or "Z"
- DIGIT 12 OPTIONS "E", "D", "F", or "P" ARE NOT AVAILABLE WHEN DIGIT 13 OPTIONS ARE "G", "H", or "J".

③ CLIMADRY® II OPTION COMPONENTS

⑥ REHEAT COIL
3-WAY MOTORIZED VALVE
PROPORTIONAL CONTROL
CIRCULATING PUMP
PUMP CONTACTOR
HOT GAS BYPASS

Notes:

- ClimaDry® II reheat option (Digit 12 - D, E, F or P) must be ordered with original equipment (cannot be field added). Unit must have DXM2.5 control. 460 volts require 4 wire power supply with neutral. Not available for units with internal water valve, flow regulator options, or 575Volt. Check unit submittal for limitations and specific requirements.
- All TRE rooftops with the ClimaDry II reheat option require antifreeze to protect the reheat coil in low ambient conditions. ASHRAE minimums for the region shall be considered during the calculation of the antifreeze solution.
- ClimaDry II is not recommended for applications with poor water quality (see water quality guidelines in unit IOM). The copper heat exchanger (Digit 12 - D or E) with cast iron pump are designed for closed loop systems.
- Max working water pressure for the ClimaDry II option is 145psig.
- Thermostat must be either:
 - Thermostat with dehumidification mode (ATP32U04 or similar)
 - Thermostat and separate humidistat or dehumidistat controller (see Table 2 for DXM2.5 DIP settings).
- ClimaDry II units must have minimum entering air temperature of 65°F DB / 55°F WB while in the cooling, continuous fan, or dehumidification modes. Minimum entering air temperature while operating in the heating mode (not continuous fan) is the minimum entering air temperature for the standard model (without the ClimaDry II option) in the heating mode. Operating below these minimum entering air temperatures may result in nuisance faults.

ClimaDry® II Option – Benefits and Application

ClimaDry® II Modulating Reheat Option

ClimateMaster's patented ClimaDry® II Dehumidification option is an innovative means of providing modulating reheat without the complication of refrigeration controls. ClimaDry II is hot gas generated reheat, which utilizes one of the biggest advantages of a Water-Source Heat Pump (WSHP), the transfer of energy through the water piping system. ClimaDry II simply diverts condenser water through a water-to-air coil that is placed after the evaporator coil. If condenser water is not warm enough, the internal "run-around" loop increases the water temperature with each pass through the condenser coil (see figure 1, below).

ClimaDry® II Benefits

ClimaDry® II is like no other reheat option on the market. Proportional reheat is controlled to the desired leaving air temperature set point (factory set point of 72°F, 22°C), no matter what the water loop temperature is. Since dehumidification operation will occur under less than full load cooling conditions a good percentage of the time, it is important to have a reheat function that provides 100% reheat in the spring and fall when the water loop is cool. Supply air temperature is field adjustable to +/- 3°F [+/- 1.7°C] for even greater flexibility with the optional potentiometer. It is recommended that the ClimaDry II supply air temperature be set to match the space cooling setpoint so that ClimaDry II does not impact room temperature. Competitors without ClimaDry II typically use an on/off (non-modulating) refrigeration based reheat circuit, typically referred to as "Hot gas reheat" (HGR). HGR needs higher condensing temperatures to work well, typically

85°F [29°C] entering water temperature (EWT). With HGR, cooler water temperatures produce cooler supply air temperatures, which could overcool the space, requiring additional space heating from another source or a special auto-change-over relay to allow the unit to switch back and forth between reheat and heating. Rarely does HGR provide 100% reheat, like ClimaDry II. ClimaDry II has a simple and easy to troubleshoot refrigerant circuit. No switching valves or hard to diagnose leaky check valves are utilized. No unusual refrigerant pressures occur during the reheat mode. The ClimaDry II refrigerant circuit is like every other ClimateMaster unit (without reheat), so everything the technician already knows applies to troubleshooting the ClimaDry II refrigeration circuit. Plus, the water loop portion of the ClimaDry II option is easy to understand and diagnose.

ClimaDry® II Applications

ClimaDry® II can be applied to a number of common applications, such as:

- Classrooms.
- Condominiums.
- Apartments.
- Computer rooms.
- Spaces with high latent loads like auditoriums, theaters, convention centers, etc.
- Most applications where humidity is a problem.

(Note: ClimaDry II is not for use in high fraction outdoor air applications or in applications with corrosive atmospheres, such as pool rooms.)

Figure 1: ClimaDry® II Schematic

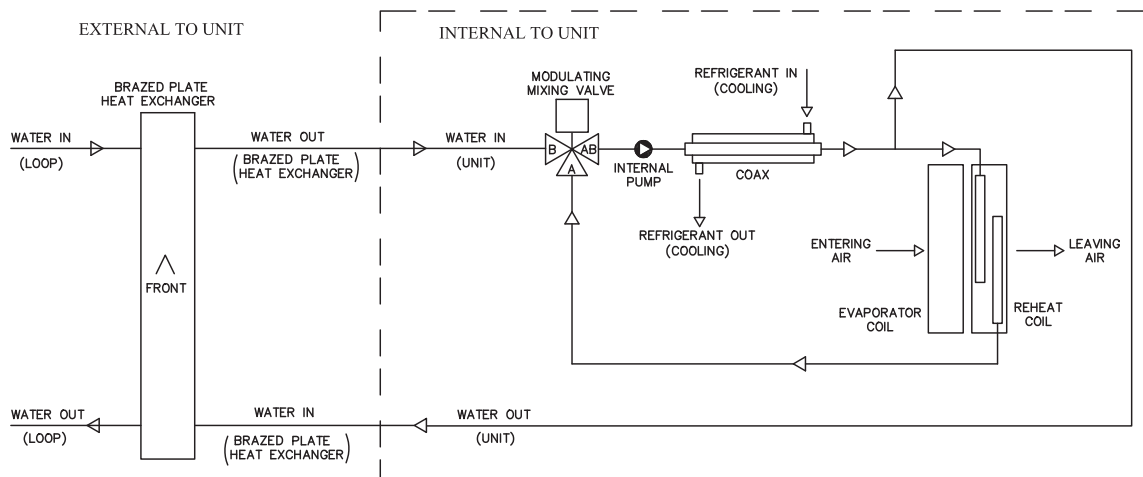

NOTE:
Brazen plate heat exchanger is used when connecting to a loop with no antifreeze.

ClimaDry® II Option – Benefits and Application

With the ClimaDry® II option, return air from the space is cooled by the air-to-refrigerant (evaporator) coil, and then reheated by the water-to-air (reheat) coil to dehumidify the air, but maintain the same space temperature (thus operating as a dehumidifier).

The moisture removal capability of the heat pump is determined by the unit's latent capacity rating. Latent capacity equals Total capacity minus Sensible capacity. Using unit performance data from submittals (<http://www.climatemaster.com/>) select the correct model, use your maximum entering water temperature (EWT) and flow rate to select TC and SC. For example, at 80°F [26.7°C] EWT and 15 GPM, the moisture removal capability (latent capacity) of a ClimateMaster TRE120 is 36.4 Mbtuh as shown as shown below.

Dividing the latent capacity by 1,069 BTU/LB of water vapor at 80°F DB and 67°F WB [26.7°C DB and 19.4°C WB] moist air enthalpy, converts the amount of moisture removal to pounds per hour (multiply pounds per hour by 0.4536 to obtain kg/hr). Calculations are shown below.

Example TRE120 Performance

4000 CFM Nominal (Rated) Airflow

$$LC = TC - SC = 121.2 - 84.8 = 36.4 \text{ Mbtuh}$$

$$36,400 \text{ Btuh} \div 1,069 = 34.1 \text{ lbs/hr (15.4 kg/hr)}$$

Water/Brine				Cooling - EAT 80/67°F					Heating - EAT 70°F				
EWT °F	Flow GPM	PD PSI	PD FT	TC	SC	kW	HR	EER	HC	kW	HE	LAT	COP
80	15.0	0.2	0.5	121.2	84.8	9.93	155.1	12.2	162.8	10.86	125.7	105.6	4.4
	22.5	0.4	1.0	126.2	87.0	9.28	157.9	13.6	171.5	11.08	133.7	107.6	4.5
	30.0	1.5	3.6	128.7	88.1	8.97	159.3	14.3	176.2	11.20	138.0	108.7	4.6
85	15.0	0.2	0.5	117.6	83.2	10.43	153.2	11.3	170.0	11.04	132.3	107.3	4.5
	22.5	0.4	0.9	122.6	85.4	9.75	155.9	12.6	179.2	11.27	140.7	109.4	4.7
	30.0	1.5	3.5	125.2	86.6	9.41	157.3	13.3	184.1	11.40	145.2	110.5	4.7
90	15.0	0.1	0.3	114.0	81.7	10.92	151.3	10.4	177.3	11.22	139.0	108.9	4.6
	22.5	0.4	0.9	119.1	83.9	10.21	153.9	11.7	186.8	11.47	147.7	111.1	4.8
	30.0	1.5	3.4	121.7	85.0	9.87	155.3	12.3	192.0	11.60	152.5	112.4	4.9
100	15.0	0.1	0.2	107.0	79.1	12.02	148.0	8.9	Operation not recommended				
	22.5	0.3	0.8	111.8	80.9	11.25	150.2	9.9					
	30.0	1.4	3.3	114.4	81.9	10.87	151.5	10.5					
110	15.0	0.1	0.2	100.5	77.2	13.24	145.6	7.6					
	22.5	0.3	0.7	104.8	78.4	12.40	147.1	8.5					
	30.0	1.4	3.2	107.2	79.1	12.00	148.1	8.9					
120	15.0	0.1	0.1	94.8	76.6	14.59	144.6	6.5					
	22.5	0.3	0.7	98.5	76.9	13.67	145.1	7.2					
	30.0	1.3	3.0	100.5	77.2	13.23	145.6	7.6					

Dividing the latent capacity by 1,069 BTU/LB of water vapor at 80°F DB and 67°F WB [26.7°C DB and 19.4°C WB] moist air enthalpy, converts the amount of moisture removal to pounds per hour (multiply pounds per hour by 0.4536 to obtain kg/hr). Calculations are shown in figure 2.

Interpolation is permissible, extrapolation is not.
 All entering air conditions are 80°F DB and 67°F WB in cooling and 70°F DB in heating.
 All performance data is based upon the lower voltage of dual voltage rated units.

ClimateMaster works continually to improve its products. As a result, the design and specifications of each product at the time of order may be changed without notice and may not be as described herein. Please contact ClimateMaster's Customer Service Department at 1-405-745-6000 for specific information on the current design and specifications. Statements and other information contained herein are not express warranties and do not form the basis of any bargain between the parties, but are merely ClimateMaster's opinion or commendation of its products. The latest version of this document is available at climatemaster.com. © ClimateMaster, Inc. All rights reserved 2010

ClimaDry® II – Sequence of Operation

ClimaDry® II Sequence of Operation

A heat pump equipped with ClimaDry® II can operate in three modes; cooling, cooling with reheat (dehumidification), and heating. The cooling/heating modes are like any other ClimateMaster WSHP. The reversing valve (“O” signal) is energized in cooling, along with the compressor contactor(s) and blower relay. In the heating mode the reversing valve is de-energized. Almost any thermostat will activate the heat pump in heating or cooling modes. The DXM2.5 microprocessor board, which is required with the ClimaDry II option, will accept either heat pump (Y,O) thermostats or non-heat pump (Y,W) thermostats. The reheat mode requires either a separate humidistat/dehumidistat or a thermostat that has an integrated dehumidification function for activation. The DXM2.5 board is configured to work with either a humidistat or dehumidistat input to terminal “H” (DIP switch settings for the DXM2.5 board are shown below in table 2). Upon receiving an “H” input, the DXM2.5 board will activate the cooling mode and engage reheat. Tables 1 and 2 show the relationship between thermostat input signals and unit operation.

There are four operational inputs for single stage units and six operational inputs for dual stage units:

- Fan Only
- 1st Stage Cooling
- 2nd Stage Cooling
- 1st Stage Heating
- 2nd Stage Heating
- Reheat Mode

Fan Only: A (G) call from the thermostat to the (G) terminal of the DXM2.5 control board will bring the unit on in fan only mode.

1st Stage Cooling: A simultaneous call from (G), (Y1), and (O) to the (G), (Y1), (O/W2) terminals of the DXM2.5 control board will bring the unit on in 1st Stage Cooling.

2nd Stage Cooling: A simultaneous call from (G), (Y1), (Y2), and (O) to the (G), (Y1), (Y2), and (O/W2) terminals of the DXM2.5 control board will bring the unit on in 2nd Stage Cooling. When the call is satisfied at the thermostat the unit will continue to run in 1st Stage Cooling until the 1st Stage Cooling call is removed or satisfied, shutting down the unit. **NOTE: Not all units have two-stage cooling functionality. (e.g. TRE036-072 units)**

Table 1: Humidistat/Dehumidistat Logic and DXM2.5 (2.1, 2.2., 2.3) DIP settings

Sensor	2.1	2.2	2.3	Logic	Reheat (ON)–H	Reheat (OFF)–H
Humidistat	OFF	OFF	OFF	Reverse	0 VAC	24 VAC
Dehumidistat	OFF	ON	OFF	Standard	24 VAC	0 VAC

Table 2: ClimaDry® II Operating Modes

Mode	Input					Output				
	O	G	Y1	Y2 ³	H	O	G	Y1	Y2 ³	Reheat
No Demand	ON/OFF	OFF	OFF	OFF	OFF	ON/OFF	OFF	OFF	OFF	OFF
Fan Only	ON/OFF	ON	OFF	OFF	OFF	ON/OFF	ON	OFF	OFF	OFF
Cooling 1st Stage	ON	ON	ON	OFF	OFF	ON	ON	ON	OFF	OFF
Cooling 2nd Stage	ON	ON	ON	ON	OFF	ON	ON	ON	ON	OFF
Cooling & Dehumidistat ¹	ON	ON	ON	ON/OFF	ON	ON	ON	ON	ON/OFF	OFF
Dehumidistat Only	ON/OFF	OFF	OFF	OFF	ON	ON	ON	ON	ON	ON
Heating 1st Stage	OFF	ON	ON	OFF	OFF	OFF	ON	ON	OFF	OFF
Heating 2nd Stage	OFF	ON	ON	ON	OFF	OFF	ON	ON	ON	OFF
Heating & Dehumidistat ²	OFF	ON	ON	ON/OFF	ON	OFF	ON	ON	ON/OFF	OFF

¹Cooling input takes priority over dehumidify input.

²DXM2.5 is programmed to ignore the H demand when the unit is in heating mode.

³N/A for single stage units; Full load operation for dual capacity units.

⁴ON/OFF = Either ON or OFF.

ClimaDry® II – Sequence of Operation

1st Stage Heating: A simultaneous call from (G) and (Y1) to the (G) and (Y1) terminals of the DXM2.5 control board will bring the unit on in 1st Stage Heating.

2nd Stage Heating: A simultaneous call from (G), (Y1), and (Y2) to the (G), (Y1), and (Y2) terminals of the DXM2.5 control board will bring the unit on in 2nd Stage Heating. When the call is satisfied at the thermostat the unit will continue to run in 1st Stage Heating until the call is removed or satisfied, shutting down the unit. **NOTE: Not all units have two-stage heating functionality (e.g. TRE036-072 units).**

Reheat Mode: A call from the Humidistat/Dehumidistat to the (H) terminal of the DXM2.5 control board will bring the unit on in Reheat Mode if there is no call for cooling at the thermostat. When the Humidistat/Dehumidification call is removed or satisfied the unit will shut down.

NOTE: Cooling always overrides Reheat Mode. In the Cooling mode, the unit cools and dehumidifies. If the cooling thermostat is satisfied but there is still a call for dehumidification, the unit will continue to operate in Reheat Mode.

NOTE: Care must be taken when using a humidistat to operate ClimaDry II. When the DIP switch on the DXM2.5 controller is set for 'humidistat' it reverses the control logic so that an "open" control circuit initiates a ClimaDry II run cycle. If a humidistat is not connected, or if a manual switch on the humidistat is set to "off", ClimaDry II will see the open circuit and call for dehumidification.

TRE ClimaDry® II Component Functions

The ClimaDry® II option consists of the following components:

- Motorized Valve/Proportional Controller
- Supply Air Sensor
- Loop Pump
- Hydronic Coil
- Low Pressure Switch

The Proportional Controller operates on 24 VAC power supply and automatically adjusts the water valve based upon the Supply Air Sensor. The Supply Air Sensor senses supply air temperature at the blower inlet providing the input signal necessary for the proportional control to drive the motorized valve during the reheat mode of operation.

The Motorized Valve is a proportional actuator/three-way valve combination used to divert the condenser water from the coax to the hydronic reheat coil during the reheat mode of operation. The proportional controller signals the motorized valve based on the supply air temperature of the supply air sensor.

The Loop Pump circulates condenser water through the hydronic reheat coil during the reheat mode of operation. In this application, the loop pump is only energized during the reheat mode of operation. The Hydronic Coil is utilized during the reheat mode of operation to reheat the air to the setpoint of the proportional controller. Condenser water is diverted by the motorized valve and pumped through the hydronic coil by the loop pump in proportion to the control setpoint. The amount of reheating is dependent on the setpoint and how far from setpoint the supply air temperature is. The factory setpoint is 72°F [22°C], generally considered "neutral" air.

ClimaDry® II Application Considerations

The reheat coil adds a small amount of resistance to the air stream. In some cases the high static option may be required for applications with higher static ductwork. Consult the submittal data or the Installation/Operation/Maintenance (I.O.M.) manual for the specific heat pump to review blower tables.

Unlike most hot gas reheat options, the ClimaDry® II option will operate over a wide range of EWTs. Special flow regulation (water regulating valve) is not required for low EWT conditions.

TRE units with the ClimaDry® II option shall have an antifreeze solution to protect the coil in low ambient conditions. ASHRAE minimums for the region shall be considered during the calculation of the antifreeze solution.

In applications where antifreeze is not specified, a secondary heat exchanger can be used to isolate the TRE from the water loop, thus requiring less antifreeze to be used with the TRE Secondary brazed plate heat exchanger. Figure 1 on page 40 shows the heat exchanger connections.

Water-source heat pumps with ClimaDry II should not be used as make-up air units. These applications should use equipment specifically designed for make-up air.

TRE036 - 072 Dimensional Data

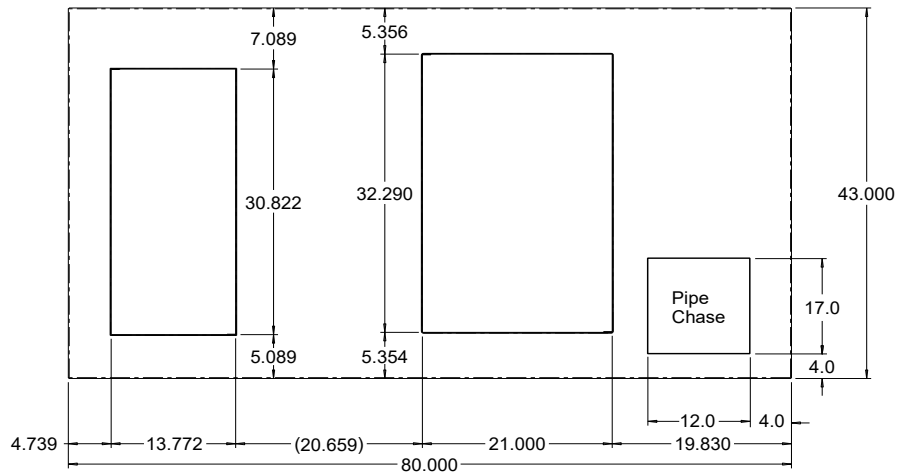
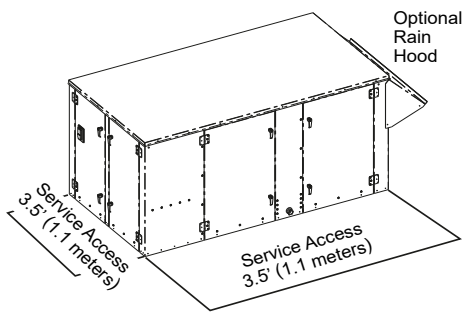
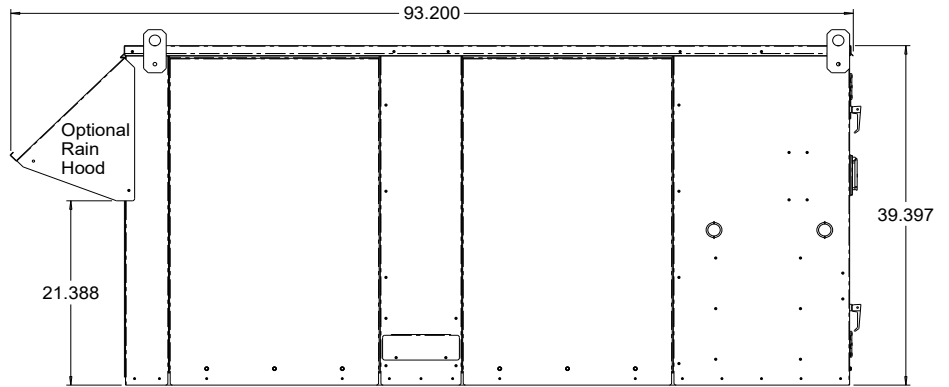
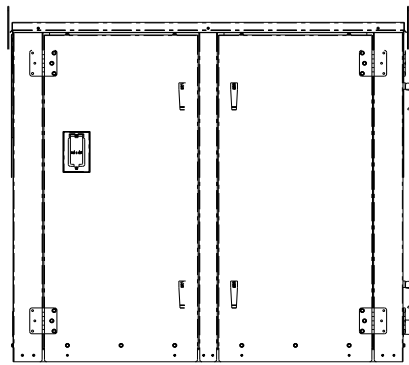

Top View of Base

Size	Outdoor Air Opening	Water In/Out (IPT)	Condensate
TRE36	12.57" x 30"	3/4"	1"
TRE48	12.57" x 30"	3/4"	1"
TRE60	12.57" x 30"	1"	1"
TRE72	12.57" x 30"	1-1/4"	1"

ClimateMaster works continually to improve its products. As a result, the design and specifications of each product at the time of order may be changed without notice and may not be as described herein. Please contact ClimateMaster's Customer Service Department at 1-405-745-6000 for specific information on the current design and specifications. Statements and other information contained herein are not express warranties and do not form the basis of any bargain between the parties, but are merely ClimateMaster's opinion or commendation of its products. The latest version of this document is available at climatemaster.com. © ClimateMaster, Inc. All rights reserved 2010

TRE096 - 144 Dimensional Data

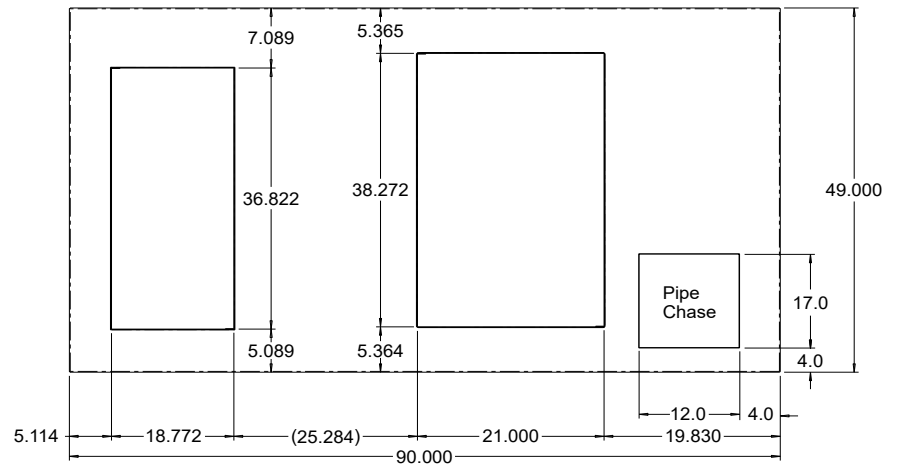
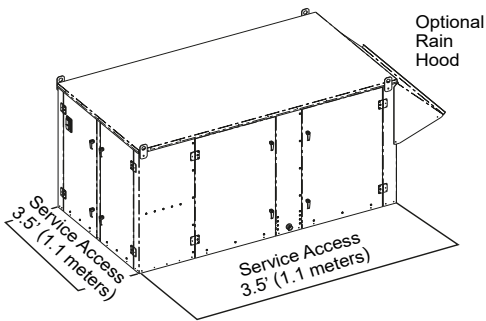
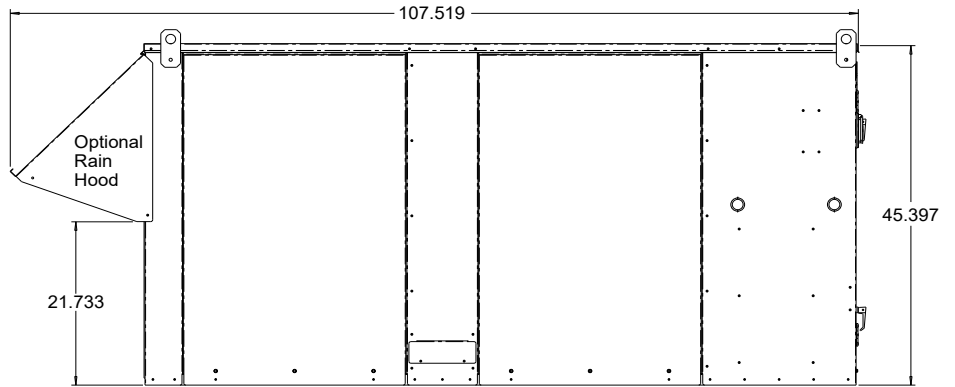
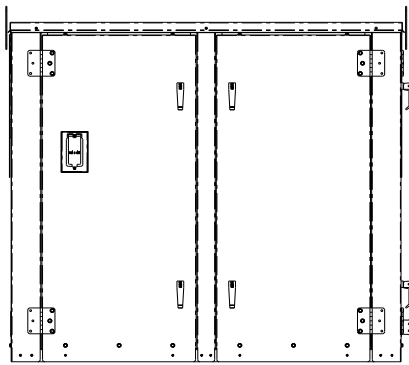

Top View of Base

Size	Outdoor Air Opening	Water In/Out (IPT)	Condensate
TRE96	18.95" x 36"	1-1/2"	1"
TRE120	18.95" x 36"	1-1/2"	1"
TRE144	18.95" x 36"	1-1/2"	1"

TRE168 - 240 Dimensional Data

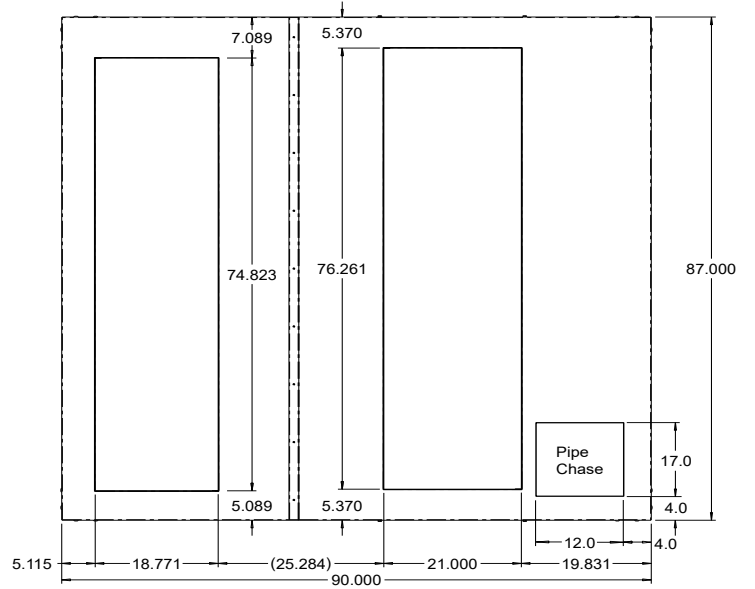
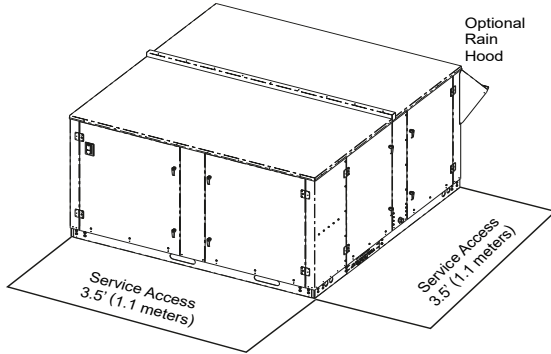
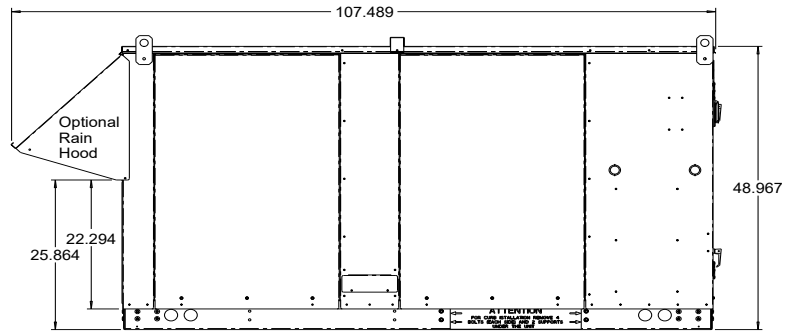
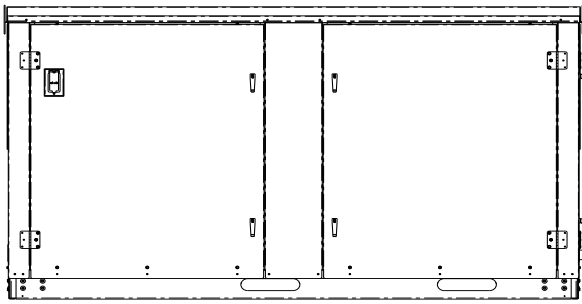

Top View of Base

Size	Outdoor Air Opening	Water In/Out (IPT)	Condensate
TRE168	18.95" x 74"	2"	1"
TRE240	18.95" x 74.2"	2"	1"

Standard Roof Curb

Model	A	B	C	D	E	F*
TRE036/48/60/72	72.25"	18"	35.25"	72.25"	35.25"	14" or 24"
TRE096/120/144	82.25"	21"	41.25"	82.25"	41.25"	14" or 24"
TRE168/240	82.25"	21"	78.88"	82.25"	78.88"	14" or 24"

* "F" dimension can be 14" or 24"

FEATURES

- 1 - ROOF CURB IS HEAVY GA. GALVANIZED STEEL.
- 2 - FULL PERIMETER WOOD NAILER PROVIDED.
- 3 - GASKET MATERIAL & ASSEMBLY HARDWARE PROVIDED.
- 4 - TOP CORNERS ARE MITRED.
- 5 - CURBS ARE SHIPPED KNOCKED DOWN.
- 6 - OTHER AVAILABLE OPTIONS BY SPECIAL REQUEST INCLUDE SINGLE PITCH, COMPOUND PITCH AND CONSTRUCTION FOR STANDING SEAM ROOFS.

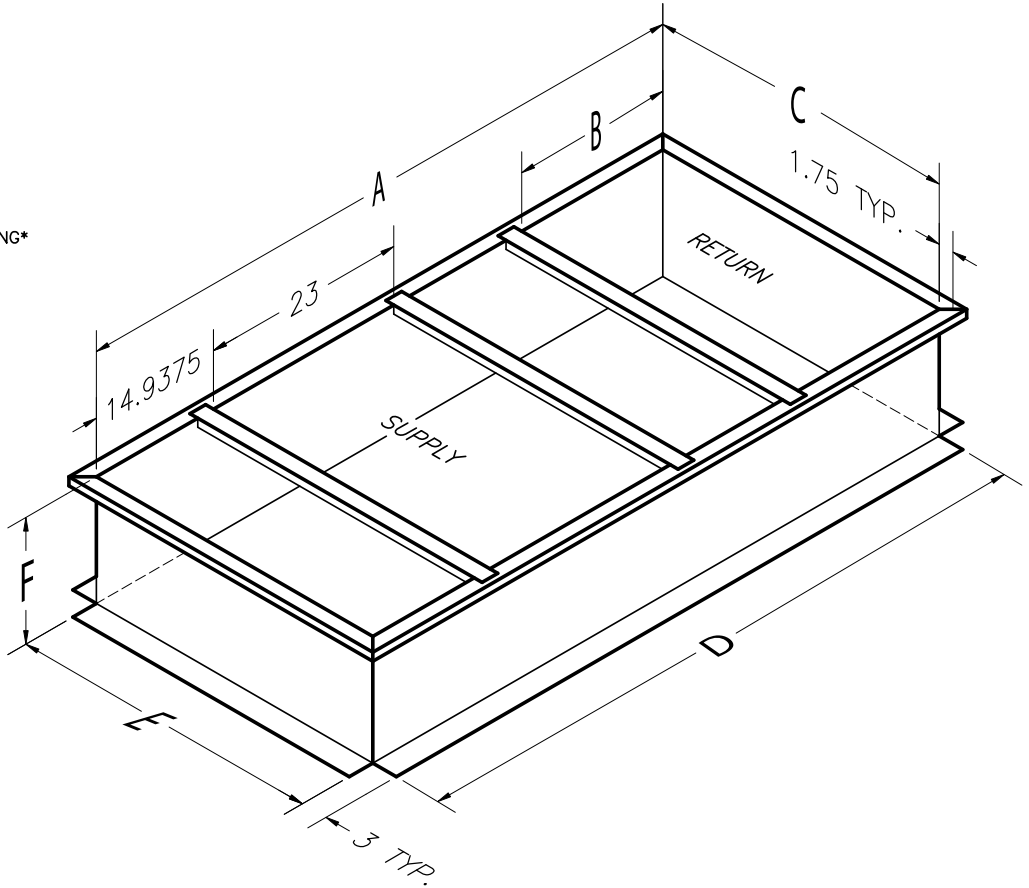
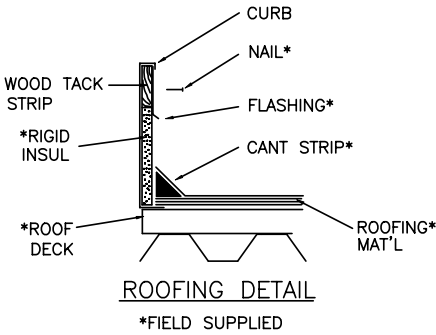

TRE Electrical Data

Model #	Voltage Code	Voltage	Min/Max Voltage	Blower Option	Compressor			Blower Motor			Total FLA/ Rated Current	SCCR kA rms symmetrical	SCCR Volts Maximum	Min Circuit Amp	Max Fuse/ HACR
					QTY	RLA	LRA	QTY	FLA	HP					
TRE036	H	208-3-60	197/254	A, B, C	1	10.4	73.0	1	4.0	1.0	14.4	N/A	N/A	17.0	25
	F	460-3-60	414/506	A, B, C	1	5.8	38.0	1	2.0	1.0	7.8	N/A	N/A	9.3	15
	N	575-3-60	518/633	A, B, C	1	3.8	36.5	1	1.4	1.0	5.2	N/A	N/A	6.2	15
TRE048	H	208-3-60	197/254	A, B, C	1	13.7	83.1	1	4.0	1.0	17.7	N/A	N/A	21.1	35
	H	208-3-60	197/254	D, E	1	13.7	83.1	1	5.0	1.5	18.7	N/A	N/A	22.1	35
	F	460-3-60	414/506	A, B, C	1	6.2	41.0	1	2.0	1.0	8.2	N/A	N/A	9.8	15
	F	460-3-60	414/506	D, E	1	6.2	41.0	1	2.4	1.5	8.6	N/A	N/A	10.2	15
	N	575-3-60	518/633	A, B, C	1	4.8	33.0	1	1.4	1.0	6.2	N/A	N/A	7.4	15
	N	575-3-60	518/633	D, E	1	4.8	33.0	1	1.9	1.5	6.7	N/A	N/A	7.9	15
TRE060	H	208-3-60	197/254	A, B, C	1	15.6	110.0	1	4.0	1.0	19.6	N/A	N/A	23.5	35
	H	208-3-60	197/254	D, E	1	15.6	110.0	1	5.0	1.5	20.6	N/A	N/A	24.5	40
	F	460-3-60	414/506	A, B, C	1	7.8	52.0	1	2.0	1.0	9.8	N/A	N/A	11.8	15
	F	460-3-60	414/506	D, E	1	7.8	52.0	1	2.4	1.5	10.2	N/A	N/A	12.2	15
	N	575-3-60	518/633	A, B, C	1	5.8	38.9	1	1.4	1.0	7.2	N/A	N/A	8.7	15
TRE072	H	208-3-60	197/254	A, B, C	1	19.6	136.0	1	5.0	1.5	24.6	N/A	N/A	29.5	45
	H	208-3-60	197/254	D, E	1	19.6	136.0	1	6.2	2.0	25.8	N/A	N/A	30.7	50
	F	460-3-60	414/506	A, B, C	1	8.2	66.1	1	2.4	1.5	10.6	N/A	N/A	12.7	20
	F	460-3-60	414/506	D, E	1	8.2	66.1	1	3.1	2.0	11.3	N/A	N/A	13.4	20
	N	575-3-60	518/633	A, B, C	1	6.6	55.3	1	1.9	1.5	8.5	N/A	N/A	10.2	15
TRE096	H	208-3-60	197/254	A, B, C	2	13.7	83.1	1	6.2	2.0	33.6	N/A	N/A	37.0	50
	H	208-3-60	197/254	D, E	2	13.7	83.1	1	9.2	3.0	36.6	N/A	N/A	40.0	50
	F	460-3-60	414/506	A, B, C	2	6.2	41.0	1	3.1	2.0	15.5	N/A	N/A	17.0	20
	F	460-3-60	414/506	D, E	2	6.2	41.0	1	4.3	3.0	16.7	N/A	N/A	18.3	20
	N	575-3-60	518/633	A, B, C	2	4.8	33.0	1	2.3	2.0	11.9	N/A	N/A	13.1	15
	N	575-3-60	518/633	D, E	2	4.8	33.0	1	3.4	3.0	13.0	N/A	N/A	14.2	15
TRE120	H	208-3-60	197/254	A, B, C	2	15.6	110.0	1	9.2	3.0	40.4	N/A	N/A	44.3	50
	H	208-3-60	197/254	D, E	2	15.6	110.0	1	14.1	5.0	45.3	N/A	N/A	49.2	60
	F	460-3-60	414/506	A, B, C	2	7.8	52.0	1	4.3	3.0	19.9	N/A	N/A	21.9	25
	F	460-3-60	414/506	D, E	2	7.8	52.0	1	7.0	5.0	22.6	N/A	N/A	24.6	30
	N	575-3-60	518/633	A, B, C	2	5.8	38.9	1	3.4	3.0	15.0	N/A	N/A	16.5	20
	N	575-3-60	518/633	D, E	2	5.8	38.9	1	5.2	5.0	16.8	N/A	N/A	18.3	20
TRE144	H	208-3-60	197/254	A, B, C	2	19.6	136.0	1	9.2	3.0	48.4	5	600	53.3	70
	H	208-3-60	197/254	E	2	19.6	136.0	1	14.1	5.0	53.3	5	600	58.2	70
	F	460-3-60	414/506	A, B, C	2	8.2	66.1	1	4.3	3.0	20.7	N/A	N/A	22.8	30
	F	460-3-60	414/506	E	2	8.2	66.1	1	7.0	5.0	23.4	N/A	N/A	25.5	30
	N	575-3-60	518/633	A, B, C	2	6.6	55.3	1	3.4	3.0	16.6	N/A	N/A	18.3	20
	N	575-3-60	518/633	E	2	6.6	55.3	1	5.2	5.0	18.4	N/A	N/A	20.1	25
TRE168	H	208-3-60	197/254	A, B, C	2	23.2	164.0	1	9.2	3.0	55.6	5	600	61.4	80
	H	208-3-60	197/254	D, E	2	23.2	164.0	1	14.1	5.0	60.5	5	600	66.3	80
	F	460-3-60	414/506	A, B, C	2	11.2	75.0	1	4.3	3.0	26.7	N/A	N/A	29.5	40
	F	460-3-60	414/506	D, E	2	11.2	75.0	1	7.0	5.0	29.4	N/A	N/A	32.2	40
	N	575-3-60	518/633	A, B, C	2	7.9	54.0	1	3.4	3.0	19.2	N/A	N/A	21.2	25
	N	575-3-60	518/633	D, E	2	7.9	54.0	1	5.2	5.0	21.0	N/A	N/A	23.0	30
TRE240	H	208-3-60	197/254	A, B, C	2	30.1	225.0	1	14.1	5.0	74.3	5	600	81.8	110
	H	208-3-60	197/254	D, E	2	30.1	225.0	1	21.7	7.5	81.9	5	600	89.4	110
	F	460-3-60	414/506	A, B, C	2	16.7	114.0	1	7.0	5.0	40.4	N/A	N/A	44.6	60
	F	460-3-60	414/506	D, E	2	16.7	114.0	1	10.0	7.5	43.4	N/A	N/A	47.6	60
	N	575-3-60	518/633	A, B, C	2	12.2	80.0	1	5.2	5.0	29.6	N/A	N/A	32.7	40
	N	575-3-60	518/633	D, E	2	12.2	80.0	1	7.8	7.5	32.2	N/A	N/A	35.3	45

Blower Options
A = Standard RPM, Standard Motor
B = Low RPM, Standard Motor
C = High RPM, Standard Motor
D = Standard RPM, Large Motor
E = High RPM, Large Motor

Note: Optional GFI convenience outlet is unpowered.

TRE Electrical Data: ClimaDry® II or Internal Secondary Pump

Model #	Voltage Code	Voltage	Min/Max Voltage	Blower Option	Compressor			Blower Motor			Pump		Total FLA/ Rated Current	SCCR kA rms symmetrical	SCCR Volts Maximum	Min Circuit Amp	Max Fuse/H ACR
					QTY	FLA	LRA	QTY	FLA	HP	QTY	FLA					
TRE036	H	208-3-60	197/254	A, B, C	1	10.4	73.0	1	4.0	1.0	1	1.07	15.5	N/A	N/A	18.1	25
	F	460-3-60	414/506	A, B, C	1	5.8	38.0	1	2.0	1.0	1	1.07	8.9	N/A	N/A	10.3	15
TRE048	H	208-3-60	197/254	A, B, C	1	13.7	83.1	1	4.0	1.0	1	1.07	18.8	N/A	N/A	22.2	35
	H	208-3-60	197/254	D, E	1	13.7	83.1	1	5.0	1.5	1	1.07	19.8	N/A	N/A	23.2	35
	F	460-3-60	414/506	A, B, C	1	6.2	41.0	1	2.0	1.0	1	1.07	9.3	N/A	N/A	10.8	15
	F	460-3-60	414/506	D, E	1	6.2	41.0	1	2.4	1.5	1	1.07	9.7	N/A	N/A	11.2	15
TRE060	H	208-3-60	197/254	A, B, C	1	15.6	110.0	1	4.0	1.0	1	1.07	20.7	N/A	N/A	24.6	40
	H	208-3-60	197/254	D, E	1	15.6	110.0	1	5.0	1.5	1	1.07	21.7	N/A	N/A	25.6	40
	F	460-3-60	414/506	A, B, C	1	7.8	52.0	1	2.0	1.0	1	1.07	10.9	N/A	N/A	12.8	20
TRE072	F	460-3-60	414/506	D, E	1	7.8	52.0	1	2.4	1.5	1	1.07	11.3	N/A	N/A	13.2	20
	H	208-3-60	197/254	A, B, C	1	19.6	136.0	1	5.0	1.5	1	1.07	25.7	N/A	N/A	30.6	50
	H	208-3-60	197/254	D, E	1	19.6	136.0	1	6.2	2.0	1	1.07	26.9	N/A	N/A	31.8	50
	F	460-3-60	414/506	A, B, C	1	8.2	66.1	1	2.4	1.5	1	1.07	11.7	N/A	N/A	13.7	20
TRE096	F	460-3-60	414/506	D, E	1	8.2	66.1	1	3.1	2.0	1	1.07	12.4	N/A	N/A	14.4	20
	H	208-3-60	197/254	A, B, C	2	13.7	83.1	1	6.2	2.0	1	1.10	34.7	N/A	N/A	38.1	50
	H	208-3-60	197/254	D, E	2	13.7	83.1	1	9.2	3.0	1	1.10	37.7	N/A	N/A	41.1	50
	F	460-3-60	414/506	A, B, C	2	6.2	41.0	1	3.1	2.0	1	0.55	16.1	N/A	N/A	17.6	20
	F	460-3-60	414/506	D, E	2	6.2	41.0	1	4.3	3.0	1	0.55	17.3	N/A	N/A	18.8	25
	N	575-3-60	518/633	A, B, C	2	4.8	33.0	1	2.3	2.0	1	0.44	12.3	N/A	N/A	13.5	15
TRE120	N	575-3-60	518/633	D, E	2	4.8	33.0	1	3.4	3.0	1	0.44	13.4	N/A	N/A	14.6	15
	H	208-3-60	197/254	A, B, C	2	15.6	110.0	1	9.2	3.0	1	1.10	41.5	N/A	N/A	45.4	60
	H	208-3-60	197/254	D, E	2	15.6	110.0	1	14.1	5.0	1	1.10	46.4	N/A	N/A	50.3	60
	F	460-3-60	414/506	A, B, C	2	7.8	52.0	1	4.3	3.0	1	0.55	20.5	N/A	N/A	22.4	30
	F	460-3-60	414/506	D, E	2	7.8	52.0	1	7.0	5.0	1	0.55	23.2	N/A	N/A	25.1	30
	N	575-3-60	518/633	A, B, C	2	5.8	38.9	1	3.4	3.0	1	0.44	15.4	N/A	N/A	16.9	20
TRE144	N	575-3-60	518/633	D, E	2	5.8	38.9	1	5.2	5.0	1	0.44	17.2	N/A	N/A	18.7	20
	H	208-3-60	197/254	A, B, C	2	19.6	136.0	1	9.2	3.0	1	1.10	49.5	5	600	54.4	70
	H	208-3-60	197/254	E	2	19.6	136.0	1	14.1	5.0	1	1.10	54.4	5	600	59.3	70
	F	460-3-60	414/506	A, B, C	2	8.2	66.1	1	4.3	3.0	1	0.55	21.3	N/A	N/A	23.3	30
	F	460-3-60	414/506	E	2	8.2	66.1	1	7.0	5.0	1	0.55	24.0	N/A	N/A	26.0	30
	N	575-3-60	518/633	A, B, C	2	6.6	55.3	1	3.4	3.0	1	0.44	17.0	N/A	N/A	18.7	25
TRE168	N	575-3-60	518/633	E	2	6.6	55.3	1	5.2	5.0	1	0.44	18.8	N/A	N/A	20.5	25
	H	208-3-60	197/254	A, B, C	2	23.2	164.0	1	9.2	3.0	1	1.96	57.6	5	600	63.4	80
	H	208-3-60	197/254	D, E	2	23.2	164.0	1	14.1	5.0	1	1.96	62.5	5	600	68.3	80
	F	460-3-60	414/506	A, B, C	2	11.2	75.0	1	4.3	3.0	1	0.98	27.7	N/A	N/A	30.5	40
	F	460-3-60	414/506	D, E	2	11.2	75.0	1	7.0	5.0	1	0.98	30.4	N/A	N/A	33.2	40
	N	575-3-60	518/633	A, B, C	2	7.9	54.0	1	3.4	3.0	1	0.78	20.0	N/A	N/A	22.0	25
TRE240	N	575-3-60	518/633	D, E	2	7.9	54.0	1	5.2	5.0	1	0.78	21.8	N/A	N/A	23.8	30
	H	208-3-60	197/254	A, B, C	2	30.1	225.0	1	14.1	5.0	1	4.50	78.8	5	600	86.3	110
	H	208-3-60	197/254	D, E	2	30.1	225.0	1	21.7	7.5	1	4.50	86.4	5	600	93.9	110
	F	460-3-60	414/506	A, B, C	2	16.7	114.0	1	7.0	5.0	1	2.25	42.7	N/A	N/A	46.8	60
	F	460-3-60	414/506	D, E	2	16.7	114.0	1	10.0	7.5	1	2.25	45.7	N/A	N/A	49.8	60
	N	575-3-60	518/633	A, B, C	2	12.2	80.0	1	5.2	5.0	1	1.80	31.4	N/A	N/A	34.5	45
	N	575-3-60	518/633	D, E	2	12.2	80.0	1	7.8	7.5	1	1.80	34.0	N/A	N/A	37.0	45

TRE Wiring Diagram Matrix

All current diagrams can be located online at climatemaster.com. Click 'Commercial Professional'.

1. Click 'Products' in the main navigation
2. Select 'Rooftop – Water Cooled'
3. Select the TRE product series
4. Click the Wire Diagrams tab in the middle of the page
5. Select your voltage and controls

Unit Controller	Reheat	Sizes	
		036-072	096-240
CXM2	None	96B0281N03	96B0281N04
DXM2.5	None	96B0281N07	96B0281N05
	Yes	96B0281N08	96B0281N06
Auxiliary WD for MPC Controls	N/A	96B0149N10	

Motorized valve and Internal Secondary Pump Options are included on the DXM2.5 base diagrams for non-ClimaDry® II applications.

Motorized outside air damper option is shown on the base unit diagrams.

Units with MPC, or Economizer options will have multiple diagrams.

Rooftop (TRE) Series 60Hz Engineering Specifications – Page 1

General:

Furnish and install ClimateMaster Tranquility® (TRE) Rooftop Water Source Heat Pumps, as indicated on the plans. Equipment shall be completely assembled, piped and internally wired. Capacities and characteristics as listed in the schedule and the specifications that follow.

Units shall be supplied completely factory built capable of operating over an entering water temperature range from 20° to 120°F (-6.7° to 48.9°C) as standard. All equipment listed in this section must be rated and certified in accordance with Air-Conditioning, Heating and Refrigeration Institute/International Standards Organization (AHRI/ISO 13256-1). All equipment must be tested, investigated, and determined to comply with the requirements of the standards for Heating and Cooling Equipment UL-1995 for the United States and CAN/CSA-C22.2 NO.236 for Canada, by Intertek Testing Laboratories (ETL). The units shall have AHRI/ISO and ETL-US-C labels.

All units shall pass a factory acceptance test. The quality control system shall automatically perform factory acceptance test via computer. A detailed report card from the factory acceptance test shall ship with each unit. **(Note: If unit fails the factory acceptance test, it shall not be allowed to ship. Unit serial number shall be recorded by factory acceptance test and furnished on report card for ease of unit warranty status.)**

Basic Construction:

Units shall be designed for outdoor installation and usage and shall be ETL or UL tested to withstand UL rain test standards.

All exterior and other painted surfaces shall be constructed of galvanized steel finished with both sides having powder paint coated surfaces. This corrosion protection system shall meet the stringent 1,000-hour salt spray test per ASTM B117.

Roof shall be constructed of a single piece of steel as described above (except on largest of unit sizes in which case shall be a maximum of two pieces joined by a standing seam construction). All roof edges shall overlap sides of unit and have a 45° lip extending away from unit sides so that rainwater drippage shall not fall on top of access doors.

Access to filters, indoor blower, electrical controls, compressor compartment, and damper section shall be provided by double wall construction for access doors and non-corrosive hardware.

The compressor and electrical control compartment shall be isolated from the system air streams.

Bottom base pan of entire unit shall have no penetrations by bolts or screws. All base pan edges and any openings shall contain 1 inch upturns at all edges and shall be sealed with silicone caulking to prevent water from dripping through base pan.

All interior surfaces shall be lined with 1 inch (25.4 mm) thick, 1-1/2 lb/ft³ (24 kg/m³) acoustic type glass fiber insulation. Insulation placement shall be designed in a manner that will eliminate any exposed edges to prevent the introduction of glass fibers into the air stream. All air handling compartments shall utilize foil faced insulation for ease of cleaning.

Standard cabinet panel insulation must meet NFPA 90A requirements, air erosion and mold growth limits of UL-181, stringent fungal resistance test per ASTM-C1071 and ASTM G21, and shall meet zero level bacteria growth per ASTM G22. **Unit insulation must meet these stringent requirements or unit(s) will not be accepted.**

Entire unit base shall be insulated on the underneath side to provide condensation protection and noise attenuation.

Rooftop (TRE) Series 60Hz Engineering Specifications – Page 2

The unit shall be furnished with 2 inch (50 mm) filter rails and one set 2 inch (50 mm) throwaway filters. Filter rails shall be field convertible without the need for additional parts to accept 4 inch filters.

Option: Unit shall be furnished with factory-installed 2 inch (50 mm) pleated filters.

Option: Unit shall be furnished with factory-configured 4 inch (100 mm) filter rails and 4 inch (100 mm) pleated filters.

Option: The unit shall be supplied with internally mounted secondary pump for primary/secondary applications, including one pipe systems.

Fan and Motor Assembly:

The assembly shall include a fan, housing and solid steel fan shaft encased in ball bearings. Unit shall have a belt drive fan assembly, fan pulley and adjustable motor sheave with V-belt drive. Fan shall be forward curved, low speed centrifugal that has been statically and dynamically balanced and tested in accordance with current A.M.C.A. standards bulletin 210. Fan bearings shall be permanently lubricated type and be self-aligning. The motor shall be a three-phase, high efficiency, ball bearing, open type with internal thermal overload protection. The motor shall be mounted on an adjustable base for proper belt tension. The fan and motor assembly must be capable of overcoming the external static pressures up to and including as shown in the unit submittal. Airflow/Static pressure rating of the unit shall be based on a wet coil and a clean filter in place. Fan and motor assembly will be mounted on an easily removable slide out assembly with safety stop for easy access and maintenance; motor shall be factory wired with wire of sufficient length to allow fan/motor assembly to be removed from unit and be placed on roof of unit for servicing.

Refrigerant Circuit:

Units shall use EarthPure® (HFC-410A) refrigerant only. Units shall have a sealed refrigerant circuit including a high efficiency scroll compressor (dual scroll compressors for units larger than 7 tons/ 24.6 kW) designed for heat pump operation, a dual port balanced thermostatic expansion valve for refrigerant metering, a filter dryer, an enhanced corrugated finned tube refrigerant to air heat exchanger, a reversing valve, a coaxial (tube in tube) refrigerant to water heat exchanger, and safety controls including a high pressure switch, low pressure switch (loss of charge), water coil low temperature sensor, and air coil low temperature sensor. Both high and low pressure switches shall be installed on Schrader fittings for service or replacement without having to evacuate and recharge refrigerant. Access fittings shall also be factory installed on high and low-pressure refrigerant lines to facilitate field service. Suction line shall be insulated to prevent condensation. Activation of any safety device shall prevent compressor operation via a microprocessor board lockout circuit. The lockout circuit shall be reset at the thermostat or at the disconnect switch. **Units that cannot be reset at the thermostat shall not be acceptable.**

The scroll compressor(s) will be mounted on external grommets specifically selected for maximized vibration attenuation. Compressor shall be mounted on a double isolation compressor deck, so as to further reduce vibration transmission to unit base. Compressor shall have thermal overload protection and be located in an insulated compartment away from air stream to minimize sound transmission.

Refrigerant to air heat exchangers shall utilize enhanced corrugated lanced aluminum fins and rifled copper tube construction rated to withstand 650 PSIG (4481 kPa) refrigerant working pressure. Refrigerant to water heat exchangers shall be of copper inner water tube that is deeply fluted, and steel refrigerant outer tube co-axial design, rated to withstand 650 PSIG (4481 kPa) working refrigerant pressure and 650 PSIG (4481 kPa) working water pressure. The refrigerant to water heat exchanger shall be “electro-coated” with a low cure cathodic epoxy material a minimum of 0.4 mils thick (0.4 – 1.5 mils range) on all surfaces. The black colored coating shall provide a minimum of 1,000 hours salt spray protection per ASTM B117-97 on all external steel and copper tubing. The material shall be formulated without the inclusion of any heavy metals and shall exhibit a pencil hardness of 2H (ASTM D3363-92A), crosshatch adhesion of 4B-5B (ASTM D3359-95), and impact resistance of 160 in-lbs (184 kg-cm) direct (ASTM D2794-93).

Rooftop (TRE) Series 60Hz Engineering Specifications – Page 3

Refrigerant metering shall be accomplished by thermostatic expansion valve only. Expansion valves shall be dual port balanced type with external equalizer for optimum refrigerant metering. Units shall be designed and tested for operating ranges of entering water temperatures from 20° to 120°F (-6.7° to 48.9°C). Reversing valve shall be four-way solenoid activated refrigerant valve, which shall default to heating mode should the solenoid fail to function. If the reversing valve solenoid defaults to cooling mode, an additional low temperature thermostat must be provided to prevent over-cooling an already cold room.

Option: The unit will be supplied with cupro-nickel coaxial water to refrigerant heat exchanger.

Option: The unit will be supplied with internally factory mounted two-way water valve with end switch for variable speed pumping requirements. A factory-mounted or field-installed high pressure switch shall be installed in the water piping to disable compressor operation in the event water pressures build due to water freezing in the piping system.

Option: Unit shall include ClimaDry® II reheat option. Only modulating reheat that will adjust capacity based upon supply air temperature to provide “neutral” (72°F, 22.2°C) constant air temperature will be accepted. “Neutral” supply air temperature shall be provided regardless of entering loop water temperatures or refrigerant condensing pressures. Control of reheat must be accomplished via a humidistat or dehumidistat contact closure. Refrigerant circuit must be AHRI certified. Approved equal manufacturers may provide pre-engineered integrated modulating hot gas reheat within the unit cabinet. Any design costs and costs of field installed items shall be borne by mechanical contractor. Refrigerant circuits that are not AHRI certified when the reheat option is applied will not be accepted. (See ClimaDry II submittal for application details and unit availability.)

Drain Pan:

The drain pan shall be constructed of 304 stainless steel. This corrosion protection system shall meet the stringent 1,000-hour salt spray test per ASTM B117. Drain pan shall be fully insulated. Drain outlet shall be located at pan as to allow complete and unobstructed drainage of condensate. Drain pan outlet side field selectable/convertible. Drain outlet shall be connected from pan directly to FPT fitting. No hidden internal tubing extensions from pan outlet extending to unit casing (that can create drainage problems) will be accepted. The unit as standard will be supplied with solid-state electronic condensate overflow protection. Mechanical float switches will NOT be accepted.

Electrical:

A control box shall be located within the unit compressor compartment and shall contain a 75VA transformer with load side circuit breaker protection, 24 volt activated, 3 pole compressor contactor, terminal block for thermostat wiring and solid-state controller for complete unit operation. Reversing valve and fan motor wiring shall be routed through this electronic controller. Units shall be name-plated for use with time delay fuses or HACR circuit breakers. Unit controls shall be 24 Volt and provide heating or cooling as required by the remote thermostat/sensor. Two compressor units shall have a solid-state time delay relay and random start to prevent both compressors from starting simultaneously.

Option: Disconnect Switch, Non-Fused

Option: Disconnect Switch, Non-Fused and unpowered 115 VAC GFI convenience outlet (separate 115 vac circuit required by others).

Option: Circuit Breaker

Rooftop (TRE) Series 60Hz Engineering Specifications – Page 4

Option: Circuit Breaker and unpowered 115 VAC GFI convenience outlet (separate 115 vac circuit required by others).

Outdoor Air:

The unit shall be supplied as standard with no outdoor air provisions (100% return air).

Option: Manual outside air damper with rain hood and bird screen sized for a maximum capacity of 20% of the total unit air volume for outside air volume.

Option: Two-position motorized outside air damper (opens outside air damper upon compressor contactor activation).

Option: Fully modulating enthalpy controlled economizer, supplied with large diameter ABS gear driven outdoor air and return air dampers. Solid-state economizer logic module shall be Honeywell W7220 series with Honeywell M7215 actuator. The economizer package shall also be supplied with gravity relief damper.

Option: Optional demand control ventilation when optional CO₂ sensor is added to economizer.

Enhanced Solid State Control System (CXM2):

Units shall have a solid-state control system. Units utilizing electro-mechanical control shall not be acceptable. The control system microprocessor board shall be specifically designed to protect against building electrical system noise contamination, EMI, and RFI interference. The control system shall interface with a heat pump type thermostat. The control system shall have the following features:

- a. Anti-short cycle time delay on compressor operation.
- b. Random start on power up mode.
- c. Low voltage protection.
- d. High voltage protection.
- e. Unit shutdown on high or low refrigerant pressures.
- f. Unit shutdown on low water temperature.
- g. Condensate overflow electronic protection.
- h. Option to reset unit at thermostat or disconnect.
- i. Automatic intelligent reset. Unit shall automatically reset the unit 5 minutes after trip if the fault has cleared. If a fault occurs 3 times sequentially without thermostat meeting temperature, then lockout requiring manual reset will occur.
- j. Ability to defeat time delays for servicing.
- k. The low-pressure switch shall not be monitored for the first 120 seconds after a compressor start command to prevent nuisance safety trips.
- l. 24V output to cycle a motorized water valve or other device with compressor contactor.
- m. Unit Performance Sentinel (UPS). The UPS warns when the heat pump is running inefficiently.
- n. Water coil low temperature sensing (selectable for water or anti-freeze).
- o. Air coil low temperature sensing.
- p. Minimized reversing valve operation (Unit control logic shall only switch the reversing valve when cooling is demanded for the first time. The reversing valve shall be held in this position until the first call for heating, ensuring quiet operation and increased valve life).
- q. Emergency shutdown contacts.
- r. Entering and leaving water temperature sensing.

Rooftop (TRE) Series 60Hz Engineering Specifications – Page 5

- s. Leaving air temperature sensing.
- t. Compressor discharge temperature sensing.

NOTE: Units not providing the 8 safety protections of anti-short cycle, low voltage, high voltage, high refrigerant pressure, low pressure (loss of charge), air coil low temperature cut-out, water coil low temperature cut-out, and condensate overflow protections will not be accepted.

When CXM2 is connected to AWC99U01 thermostat or handheld service tool, the installer/service technician can; check DIP switch S2 settings; run operation modes manually; check all physical inputs from thermostat and refrigerant pressure switches status, (Y1, Y2, W, O, G, H, ESD, NSB, OR, HP switch, and LOC switch); current or at time of fault the following temperatures - water coil (LT1), air coil (LT2), compressor discharge, leaving air, leaving water, entering water and control voltage; record last five faults, list possible reasons, and clear faults. When the AWC99U01 communicating thermostat is used this same functionality can be viewed and adjusted remotely in the web portal or mobile app. **Systems not providing remote access, diagnosis, and adjustment functionality will not be accepted.**

Option: Enhanced Solid State Control System (DXM2.5)

This control system is a communicating controller.

Control shall have the above-mentioned features of the CXM2 control system along with the following expanded features:

- a. Removable thermostat connector.
- b. Night setback control.
- c. Random start on return from night setback.
- d. Override temperature control with 2-hour timer for room occupant to override setback temperature at the thermostat.
- e. Dry contact night setback output for digital night setback thermostats.
- f. Ability to work with heat pump or heat/cool (Y, W) type thermostats.
- g. Ability to work with heat pump thermostats using O or B reversing valve control.
- h. Boilerless system heat control at low loop water temperature.
- i. Ability to allow up to 3 units to be controlled by one thermostat.
- j. Relay to operate an external damper.
- k. Relay to start system pump.
- l. 75 VA control transformer. Control transformer shall have load side short circuit and overload protection via a built-in circuit breaker.

NOTE: Units not providing the 8 safety protections of anti-short cycle, low voltage, high voltage, high refrigerant pressure, low pressure (loss of charge), air coil low temperature cut-out, water coil low temperature cut-out, and condensate overflow protection for both drain pans will not be accepted.

When DXM2.5 is connected to AWC99U01 communicating thermostat or handheld service tool, the installer/service technician can; check and set CFM; check DIP switch S1, S2, and S3 settings; run operation modes manually; check all physical inputs from thermostat and refrigerant pressure switches status, (Y1, Y2, W, O, G, H, ESD, NSB, OR, HP switch, and LOC switch); current or at time of fault the following temperatures - water coil (LT1), air coil (LT2), compressor discharge, leaving air, leaving water, entering water and control voltage; record last five faults, list possible reasons, and clear faults. When the AWC99U01 communicating thermostat is used this same functionality can be viewed and adjusted remotely with the only portal or mobile app. **Systems not providing remote access, diagnosis, and adjustment functionality will not be accepted.**

Digital Night Setback with Pump Restart (DXM2.5 w/ ATP32U03C/04C, AWC99U01):

The unit will be provided with a Digital Night Setback feature using an accessory relay on the DXM2.5 controller with an ATP32U03C/04C or AWC99U01 thermostat and an external, field-provided time clock. The external time clock will initiate and

ClimateMaster works continually to improve its products. As a result, the design and specifications of each product at the time of order may be changed without notice and may not be as described herein. Please contact ClimateMaster's Customer Service Department at 1-405-745-6000 for specific information on the current design and specifications. Statements and other information contained herein are not express warranties and do not form the basis of any bargain between the parties, but are merely ClimateMaster's opinion or commendation of its products. The latest version of this document is available at climatemaster.com. © ClimateMaster, Inc. All rights reserved 2010

Rooftop (TRE) Series 60Hz Engineering Specifications – Page 6

terminate the night setback period. The thermostat will have a night setback override feature with a programmable override time period. An additional accessory relay on the unit DXM2.5 controller will energize the building loop pump control for the duration of the override period. **(Note: This feature requires additional low voltage wiring. Consult Application Drawings for details.)**

Remote Service Sentinel

Solid-state control system shall communicate with thermostat to display (at a compatible thermostat) the unit status, fault status, and specific fault condition, as well as retrieve previously stored fault that caused unit shutdown. The Remote Service Sentinel allows building maintenance personnel or service personnel to diagnose unit from the wall thermostat. The control board shall provide a signal to the thermostat fault light, indicating a lockout. Upon cycling the G (fan) input 3 times within a 60 second time period, the fault light shall display the specific code as indicated by a sequence of flashes. A detailed flashing code shall be provided at the thermostat LED to display unit status and specific fault status such as over/under voltage fault, high pressure fault, low pressure fault, low water temperature fault, condensate overflow fault, etc. **Units that do not provide this remote service sentinel shall not be acceptable.**

Option: MPC (Multiple Protocol Control) Interface System

Units shall have all the features listed above and the control board will be supplied with a Multiple Protocol interface board. Available protocols are BACnet MS/TP, Modbus, or Johnson Controls N2. The choice of protocol shall be field selectable/changeable via the use of a simple selector switch. Protocol selection shall not require any additional programming or special external hardware or software tools. This will permit all units to be daisy chain connected by a 2-wire twisted pair shielded cable. The following points must be available at a central or remote computer location:

- a. Space temperature
- b. Leaving water temperature
- c. Discharge air temperature
- d. Command of space temperature setpoint
- e. Cooling status
- f. Heating status
- g. Low temperature sensor alarm
- h. Low pressure sensor alarm
- i. High pressure switch alarm
- j. Condensate overflow alarm
- k. Hi/low voltage alarm
- l. Fan "ON/AUTO" position of space thermostat as specified above
- m. Unoccupied/occupied command
- n. Cooling command
- o. Heating command
- p. Fan "ON/AUTO" command
- q. Fault reset command
- r. Itemized fault code revealing reason for specific shutdown fault (any one of 7)

This option also provides the upgraded 75VA control transformer with load side short circuit and overload protection via a built in circuit breaker.

Warranty:

ClimateMaster shall warranty equipment for a period of 12 months from start up or 18 months from shipping (which ever occurs first).

Option: Extended 4-year compressor warranty covers compressor for a total of 5 years.

Rooftop (TRE) Series 60Hz Engineering Specifications – Page 7

Option: Extended 4-year refrigeration circuit warranty covers coils, reversing valve, expansion valve and compressor for a total of 5 years.

Option: Extended 4-year control board warranty covers the DXM2.5 control board for a total of 5 years.

FIELD INSTALLED OPTIONS

Thermostats:

The thermostat shall be a ClimateMaster mechanical or electronic type thermostat as selected below with the described features:

a. Thermostat (Communicating) (AWC99U01)

An electronic communicating web-enabled touchscreen thermostat shall be provided. The thermostat shall offer three stages of heating and two stages of cooling with precise temperature control and have a four-wire connection to the unit. The thermostat shall be capable of manual or automatic change-over operation and shall operate in standard or programmable mode. An integrated humidity control feature shall be included to control a humidifier and/or a dehumidifier. The thermostat shall include a utility demand reduction feature to be initiated by an independent time program or an external input.

The thermostat shall provide access to via the web portal or mobile application to include temperature adjustment, schedule adjustment including occupied/unoccupied, entering water temperature, leaving water temperature, water coil temperature, air coil temperature, leaving air temperature, and compressor discharge temperature. A graphical system layout to be provided with real-time operating mode information of the temperature sensors for easy diagnostics.

The thermostat shall display system faults with probable cause and troubleshooting guidance. The system shall provide in clear language last five faults, time of faults, operating temps at time of fault, and possible reasons for the fault. The thermostat shall provide access for immediate manual control of all outputs via the web portal/mobile application for rapid troubleshooting.

b. Single-Stage Digital Auto or Manual Changeover (ATA11U01)

Thermostat shall be a single-stage, digital, auto or manual changeover with HEAT-OFF-COOL-AUTO system switch and fan ON-AUTO switch. Thermostat shall have an LCD display with temperature and setpoint(s) in °F or °C. The Thermostat shall provide permanent memory of setpoint(s) without batteries. A fault LED shall be provided to display specific fault condition. Thermostat shall provide temperature display offset for custom applications.

c. Multi-stage Manual Changeover Programmable 5/2 Day (ATP21W02)

Thermostat shall be 5 day/2 day programmable (with up to 4 setpoints per day), multi-stage (2H/1C), manual changeover with HEAT-OFF-COOL-EM HEAT system settings and fan ON-AUTO settings. Thermostat shall have an LCD display with temperature, setpoint(s), mode, and status indication. The temperature indication shall be selectable for °F or °C. The thermostat shall provide permanent memory of setpoint(s) without batteries. Thermostat shall provide convenient override feature to temporarily change setpoint.

d. Multi-stage Automatic or Manual Changeover Programmable 7 Day (ATP32U03C)

Thermostat shall be 7 day programmable (with up to 4 setpoints per day), multi-stage (3H/2C), automatic or manual changeover with HEAT-OFF-COOL-AUTO-EM HEAT system settings and fan ON-AUTO settings. Thermostat shall have a blue backlit dot matrix LCD display with temperature, setpoints, mode, and status indication. The temperature indication shall be selectable for °F or °C. Time display shall be selectable for 12 or 24 hour clock. Fault identification shall be provided (when used with ClimateMaster CXM2 or DXM2.5 controls) to simplify troubleshooting by providing specific unit fault at the thermostat with red backlit LCD during unit lockout. The thermostat shall provide permanent memory of setpoints without batteries. Thermostat shall provide heating setpoint range limit, cooling setpoint range limit, temperature display offset, keypad lockout, dead-band

ClimateMaster works continually to improve its products. As a result, the design and specifications of each product at the time of order may be changed without notice and may not be as described herein. Please contact ClimateMaster's Customer Service Department at 1-405-745-6000 for specific information on the current design and specifications. Statements and other information contained herein are not express warranties and do not form the basis of any bargain between the parties, but are merely ClimateMaster's opinion or commendation of its products. The latest version of this document is available at climatemaster.com. © ClimateMaster, Inc. All rights reserved 2010

Rooftop (TRE) Series 60Hz Engineering Specifications – Page 8

range setting, and inter-stage differential settings. Thermostat shall provide progressive recovery to anticipate time required to bring space temperature to the next programmed event. Thermostat shall provide an installer setup for configuring options and for setup of servicing contractor name and contact information. Thermostat shall allow the use of an accessory remote and/or outdoor temperature sensor (AST008). Thermostat navigation shall be accomplished via five buttons (up/down/right/left/select) with menu-driven selections for ease of use and programming.

e. Multistage Automatic or Manual Changeover Programmable 7 Day with Humidity Control (ATP32U04C)

Thermostat shall be 7 day programmable (with up to 4 setpoints per day), multi-stage (3H/2C), automatic or manual changeover with HEAT-OFF-COOL-AUTO-EM HEAT system settings and fan ON-AUTO settings. Separate dehumidification and humidification setpoints shall be configurable for discreet outputs to a dehumidification option and/or an external humidifier. Installer configuration mode shall allow thermostat dehumidification mode to operate with ClimaDry® II reheat or with ECM fan dehumidification mode via settings changes. Thermostat shall have a blue backlit dot matrix LCD display with temperature, relative humidity, setpoints, mode, and status indication. The temperature indication shall be selectable for °F or °C. Time display shall be selectable for 12 or 24 hour clock. Fault identification shall be provided (when used with ClimateMaster CXM2 or DXM2.5 controls) to simplify troubleshooting by providing specific unit fault at the thermostat with red backlit LCD during unit lockout. The thermostat shall provide permanent memory of setpoints without batteries. Thermostat shall provide heating setpoint range limit, cooling setpoint range limit, temperature display offset, keypad lockout, dead-band range setting, and inter-stage differential settings. Thermostat shall provide progressive recovery to anticipate time required to bring space temperature to the next programmed event. Thermostat shall provide an installer setup for configuring options and for setup of servicing contractor name and contact information. Thermostat shall allow the use of an accessory remote and/or outdoor temperature sensor (AST008). Thermostat navigation shall be accomplished via five buttons (up/down/right/left/select) with menu-driven selections for ease of use and programming.

f. CM100 - Multi-stage Automatic or Manual Changeover digital thermostat (ATA32V01)

Multi-stage (3H/2C), automatic or manual changeover with HEAT-OFF-COOL-AUTO-EM HEAT system settings and fan ON-AUTO settings. Thermostat shall have a green backlit LED display with temperature, setpoints, mode, and status indication via a green (cooling) or red(heating) LED. The temperature indication shall be selectable for °F or °C. Time display shall be selectable for 12 or 24 hour clock. The thermostat shall provide permanent memory of setpoints without batteries. Thermostat shall provide heating setpoint range limit, cooling setpoint range limit, temperature display offset, keypad lockout, dead-band range setting, and inter-stage differential settings. Thermostat shall provide progressive recovery to anticipate time required to bring space temperature to the next programmed event. Thermostat shall provide an installer setup for configuring. Thermostat navigation shall be accomplished via four buttons (Mode/fan/down/up) with menu-driven selections for ease of use and programming.

g. CM300 – Multi-stage, Automatic or Manual Changeover, 7-day Programmable with Wi-Fi and Humidity Control (AVB32V02C)

Residential version shall be 7 day programmable with up to 4 setpoints per day. Commercial version shall be 7 day programmable with 4 occupied/unoccupied periods per day with up to 4-hour override. Multi-stage (3H/2C), automatic or manual changeover with HEAT-OFF-COOL-AUTO-EM HEAT system settings and fan ON-AUTO settings, Wi-Fi, pre-occupancy purge fan option, night time control of display backlight, bi-color LED indicates a heating or cooling demand, keypad lock, title 24 compliant, openADR2.0b certified with Skyport web portal. Compatible with condensate overflow warning systems – lockout compressor with message on.

h. CM500 – Color Touchscreen Display, Multi-stage, Automatic or Manual Changeover, 7-day Programmable with Wi-Fi and Humidity Control (AVB32V03C)

Thermostat shall have color resistive touchscreen display with space temperature, relative humidity, setpoints, mode, status indication and local weather (if connected to Wi-Fi). Residential version shall be 7 day programmable with up to 4 setpoints per day. Commercial version shall be 7 day programmable with 4 occupied/unoccupied periods per day with up to 4-hour override. Multi-stage (3H/2C), automatic or manual changeover with HEAT-OFF-COOL-AUTO-EM HEAT system settings and fan ON-

Rooftop (TRE) Series 60Hz Engineering Specifications – Page 9

AUTO settings, Wi-Fi, pre-occupancy purge fan option, customizable screen saver and background displays, indicator on display indicates a heating or cooling demand, set-point lock, title 24 compliant, openADR2.0b certified with Skyport web portal. Compatible with condensate overflow warning systems – lockout compressor with message on the display. Capable of being monitored by 3rd party software. Compatible with AST014 Wi-Fi remote sensor. Configurator mobile app or web portal for easy setup. Separate dehumidification and humidification setpoints shall be configurable for discreet outputs to a dehumidification option and/or an external humidifier. The temperature indication shall be selectable for °F or °C. Time display shall be selectable for 12- or 24-hour clock. The thermostat shall provide permanent memory of setpoints without batteries. Thermostat shall provide heating setpoint range limit, cooling setpoint range limit, temperature display offset, dead-band range setting, and inter-stage differential settings. Thermostat shall provide progressive recovery to anticipate time required to bring space temperature to the next programmed event. Thermostat shall provide access to a web portal and mobile app for installer setup for configuring options. Thermostat shall have menu-driven selections for ease of use and programming.

DDC Sensors:

ClimateMaster wall mounted DDC sensor to monitor room temperature and interfaces with optional interface system described above. Several types as described below:

- a. Sensor only with no display (MPC).
- b. Sensor with setpoint adjustment and override (MPC only).
- c. Sensor with setpoint adjustment and override, LCD display, status/fault indication (MPC).

Roof Curbs:

A 14 inch (356 mm) high knockdown roof curb for flat roofs is available as standard in down discharge configuration. Other curbs are available by special request.

Option: A 24" high knockdown roof curb for flat roofs with downward discharge configuration.

NOTICE! This product specification document is furnished as a means to copy and paste ClimateMaster product information into project specification. It is not intended to be a complete list of product requirements. This document is an excerpt from the product submittal and must not be used without consulting the complete product submittal. For complete product installation and application requirements, please consult the complete product submittal. ClimateMaster is not responsible for misuse of this document or a failure to adequately review specific requirements in the product submittal.

Performance Sheet

SUBMITTAL DATA - I-P UNITS

Unit Designation: _____

Job Name: _____

Architect: _____

Engineer: _____

Contractor: _____

PERFORMANCE DATA

Cooling Capacity: _____ Btuh

EER: _____

Heating Capacity: _____ Btuh

COP: _____

Ambient Air Temp: _____ °F

Entering Water Temp (Clg): _____ °F

Entering Air Temp (Clg): _____ °F

Entering Water Temp (Htg): _____ °F

Entering Air Temp (Htg): _____ °F

Airflow: _____ CFM

Fan Speed or Motor/RPM/Turns: _____

Operating Weight: _____ (lb)

ELECTRICAL DATA

Power Supply: _____ Volts

_____ Phase _____ Hz

Minimum Circuit Ampacity: _____

Maximum Overcurrent Protection: _____

SUBMITTAL DATA - S-I UNITS

Unit Designation: _____

Job Name: _____

Architect: _____

Engineer: _____

Contractor: _____

PERFORMANCE DATA

Cooling Capacity: _____ kW

EER: _____

Heating Capacity: _____ kW

COP: _____

Ambient Air Temp: _____ °C

Entering Water Temp (Clg): _____ °C

Entering Air Temp (Clg): _____ °C

Entering Water Temp (Htg): _____ °C

Entering Air Temp (Htg): _____ °C

Airflow: _____ l/s

Fan Speed or Motor/RPM/Turns: _____

Operating Weight: _____ (kg)

ELECTRICAL DATA

Power Supply: _____ Volts

_____ Phase _____ Hz

Minimum Circuit Ampacity: _____

Maximum Overcurrent Protection: _____

Notes:

Revision History

Date:	Item:	Action:
02/28/23	All	Transitioned from CXM to CXM2 and DXM2 to DXM2.5 unit controls. Introduced AWC Wi-Fi cloud connected color touch screen thermostat
10/26/22	Dimensions	Updated TRE096 water connection sizes
11/02/21	All	Removed LON controller options
09/24/21	Decoder	Updated curb decoder
08/04/21	Decoders and Engineering Specs	Updated decoder pg 8 and engineering specs verbiage pg 71
10/12/20	Edits to specification verbiage	Updated pages 62, 64 and 70
9/14/20	Wire diagram matrix and AHRI ratings table	Added new wire diagram part numbers and adjusted the rated cooling capacity of TRE120 at ground water conditions
7/02/20	Decoder and Engineering Specs	Updated Pg 7 and added Options to Roof Curbs in Eng. Specs
5/29/20	All	Updated font design and Antifreeze Correction Table
03/17/20	TRE Decoder	Updated pg 7
09/12/19	Engineering Specifications	Updated
	Wiring Diagrams	Updated pgs 54-58
	Changed all DXM to DXM2	All Updated
	TRE Series Nomenclature - Decoder	Update pg 7-8
11/15/16	Document Design Update	Updated
04/12/16	Text Edit	Updated page 38
03/28/16	Pipe chase detail and page 59	Deleted page and updated run test engineering specs
07/31/15	WPD Table MWV - Page 19	Updated
07/31/15	Page 60	Updated Door Hinge Text
05/21/15	All	Updated Curb Decoder and Details
05/13/15	All	Updated to Revision D
02/18/15	Pipe Chase Dimensions	Updated



A NIBE GROUP MEMBER

7300 S.W. 44th Street
 Oklahoma City, OK 73179
 Phone: 405-745-6000
 climatemaster.com