

## T8411R Electronic Heat Pump Thermostat

### INSTALLATION INSTRUCTIONS

The T8411R Heat Pump Thermostat provides 24V control of two-stage heating and one-stage cooling heat pump system with manual changeover from heat to cool. First stage heating and cooling cycle rates are fixed at 3 cph. Second stage heating cycle rate is selectable at 3, 4, 5, 6, 9 or 12 cph. Temperature indication can be set for °F or °C.

The T8411R Heat Pump Thermostat is powered directly from the system transformer. Batteries are not required because setpoints are held permanently by non-volatile memory.

The T8411R includes a thermostat, wallplate (for wiring and mounting thermostat), and owner's guide. A 7 3/8 in. x 5 3/4 in. (188mm x146 mm) decorator cover plate (for covering wall marks) is available separately. Order Honeywell part no. 209649A (taupe color).



### MERCURY NOTICE

If this control is replacing a control that contains mercury in a sealed tube, do not place your old control in the trash.

Contact your local waste management authority for instructions regarding recycling and the proper disposal of an old control containing mercury in a sealed tube.

## INSTALLATION

### When Installing this Product...

1. Read these instructions carefully. Failure to follow them could damage the product or cause a hazardous condition.
2. Check the ratings given in the instructions and on the product to make sure the product is suitable for your application.
3. Installer must be a trained, experienced service technician.
4. After installation is complete, check out product operation as provided in these instructions.



### CAUTION

**Electrical Shock or Equipment Damage Hazard.**

**Can shock individuals or short equipment circuitry.**

Disconnect power supply before installation.

### Location

Install the thermostat about 5 ft (1.5m) above the floor in an area with good air circulation at average temperature. See Fig. 1. Do not install the thermostat where it can be affected by:

- drafts or dead spots behind doors and in corners.
- hot or cold air from ducts.
- radiant heat from the sun or appliances.
- concealed pipes and chimneys.
- unheated (uncooled) areas such as an outside wall behind the thermostat.

This thermostat is a precision instrument and was carefully adjusted at the factory. Handle it carefully.

### Mounting Wallplate to Wall

#### IMPORTANT

*Level only for appearance. The thermostat functions normally even when not level.*

Mount wallplate, T8411R and the screws provided (see Fig. 2) as follows:

1. Place the wallplate at the desired location on the wall.
2. Use a pencil to mark the mounting holes.
3. Remove the wallplate from the wall and drill two 3/16 in. holes in the wall (if drywall) or two 7/32 in. holes for firmer material such as plaster or wood.
4. Gently tap the anchors (provided) into the holes until flush with the wall.
5. Position the wallplate over the holes.
6. Pull the thermostat wire through the wallplate entrance hole.
7. Fasten the wallplate to the wall using the anchors and screws provided.



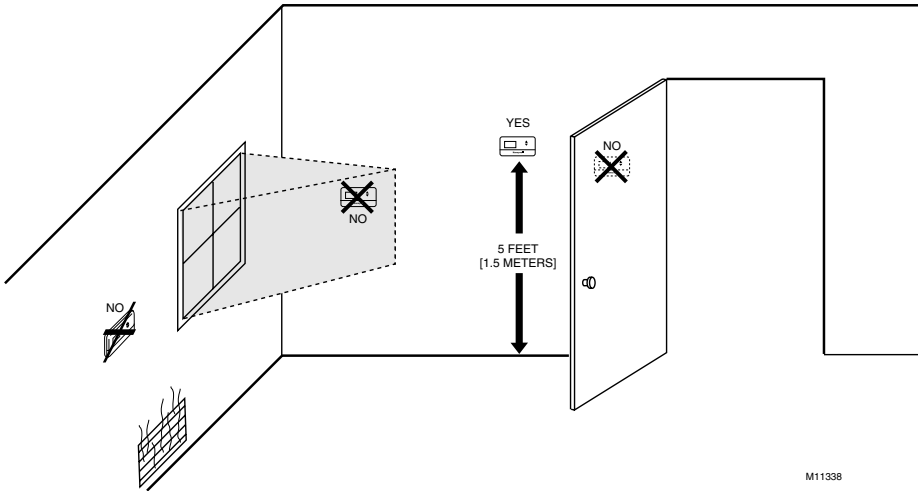

M11338

Fig. 1. Typical location of thermostat.

The shape of the terminals permits insertion of straight or wraparound wiring connections; either method is acceptable. See Fig. 3.

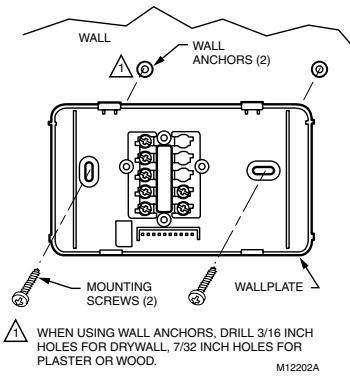

Fig. 2. Mounting wallplate to wall.

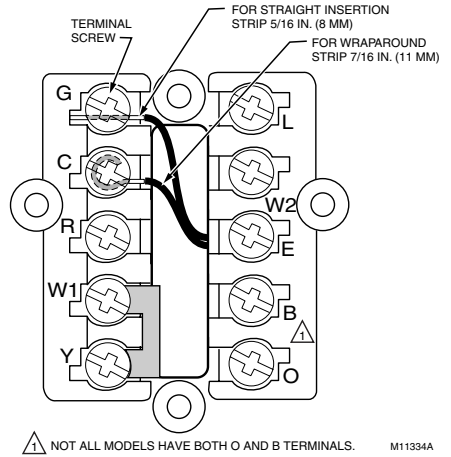

Fig. 3. Wiring connections.

NOTE: To ensure proper mounting of thermostat, restrict all wiring to the shaded area. See Fig. 4.

Wiring

**IMPORTANT**

Use an 18-gauge maximum wire for wiring the T8411R Thermostat.

All wiring must comply with local electrical codes and ordinances.

**CAUTION**

Electrical Shock or Equipment Damage Hazard.  
 Can shock individuals or short equipment circuitry.  
 Disconnect power supply before installation.

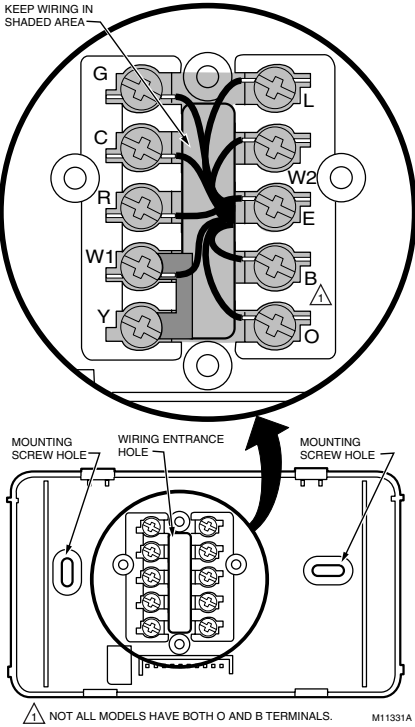

Fig. 4. RestRICT wiring to shaded area.

Refer to Fig. 5 for typical wiring hookups. A letter code is located near each terminal for identification.

1. Loosen the terminal screws on the wallplate and connect the system wires. See Fig. 5.
2. Securely tighten each terminal screw.
3. Push the excess wire back into the hole.
4. Plug the hole with nonflammable insulation to prevent drafts from affecting the thermostat.

### Mounting Thermostat to Wallplate

1. Engage the tabs at the top of the thermostat and wallplate.
2. Swing down the thermostat and press the lower edge of the thermostat onto the wallplate to latch. See Fig. 6.

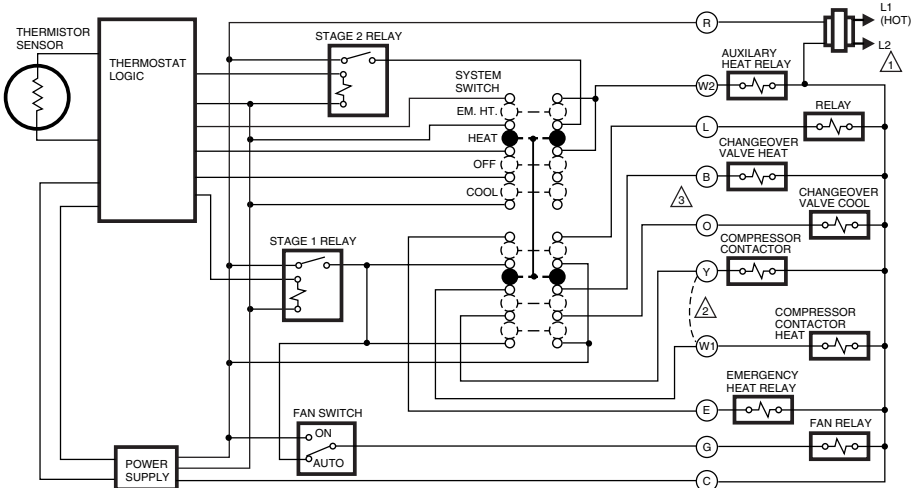

⚠ POWER SUPPLY. PROVIDE DISCONNECT MEANS AND OVERLOAD PROTECTION AS REQUIRED.

⚠ REMOVE JUMPER, WHEN SUPPLIED, FOR SYSTEMS WITH SEPARATE HEATING COMPRESSOR CONTACTOR (W1 SEPARATE FROM Y).

⚠ NOT ALL MODELS HAVE BOTH O AND B TERMINALS.

M11333A

Fig. 5. T8411R two-stage heat and one-stage cool wiring diagram with manual changeover.

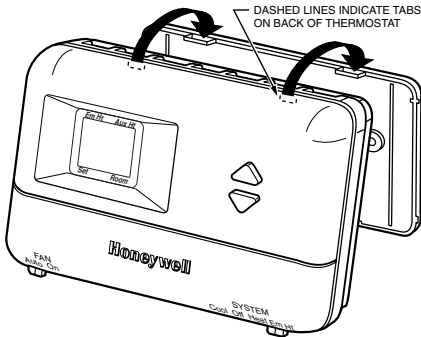

**A** ENGAGE TABS AT TOP OF THERMOSTAT WITH SLOTS ON MOUNTING PLATE.

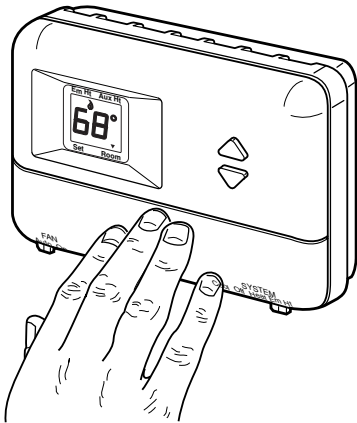

**B** PRESS LOWER EDGE OF CASE TO LATCH.

M18541

Fig. 6. Mounting thermostat wallplate.

**FAN Switch**

Fan switch settings are:

- On: The fan runs continuously. Use for improved air circulation and air quality.
- Auto: Normal setting for most homes. The fan starts and stops with the equipment.

Slide the FAN switch in the bottom left corner of the thermostat to select the desired fan setting.

**SYSTEM Switch**

System switch settings control thermostat operation as follows:

- Cool: The thermostat controls the cooling system.
- Off: Both heating and cooling are off.
- Heat: The thermostat controls the heating system.
- Em Ht: Thermostat cycles auxiliary heat (W2) and emergency heat relay (E) as needed to maintain setpoint. Terminal L is energized continuously. Fault heat relay is on continuously. Cooling system is off. Compressor is de-energized.

Slide the SYSTEM switch in the bottom right corner of the thermostat to select the desired system setting.

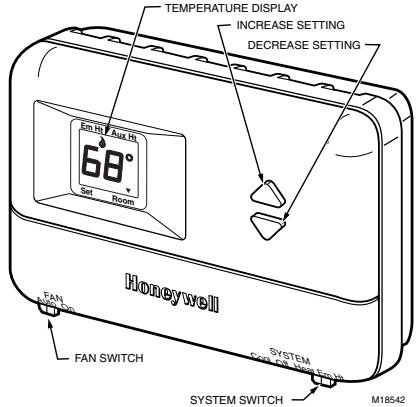

Fig. 7. Digital display and system switches (FAN and SYSTEM).

**OPERATION**

**Setting FAN and SYSTEM Switches**

Fan and system settings are controlled manually by using the switches located at the bottom of the thermostat case. See Fig. 7.

**Em Ht and Aux Ht Indications**

The ▲ indicator points to either Emergency Heat (Em Ht) or Auxiliary Heat (Aux Ht) when these modes are active.

Em Ht: The ▲ indicator points to Em Ht when the SYSTEM switch is set at Em Ht.

Aux Ht: The ▲ indicator points to Aux Ht when the auxiliary backup heat is needed to help handle the heating load.

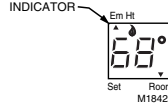

## Set Temperature Setpoint

NOTE: Temperature setpoint range is 40° to 99°F (4° to 39°C).

The temperature setpoint and the room temperature are shown separately on the digital display. The ▼ indicator points to **Set** when the temperature setpoint is displayed and to **Room** when the room temperature is displayed

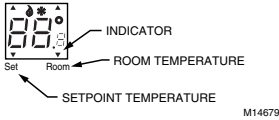

To set temperature setpoint:

1. Select Heat or Cool by sliding the SYSTEM switch in the lower right corner of the thermostat to the desired mode. See Fig. 7.
2. To display the temperature setpoint on the digital display, press either the ▲ or ▼ key once. The temperature setpoint is displayed for approximately five seconds as the indicator points to **Set** and flashes.



3. To increase the temperature setpoint press the ▲ key. Each press changes the setpoint one degree; press and hold to change the setpoint several degrees.



4. To decrease the temperature setpoint press the ▼ key. Each press changes the setpoint one degree; press and hold to change the setpoint several degrees.



## Setting °F/°C Indication and Heat Cycle Rate

NOTE: To save changes to the °F/°C indication and the heat cycle rate, all seven steps must be completed.

In installer setup mode, steps 2 through 5, each press of the ▲ key momentarily displays 01 and each press of the ▼ key momentarily displays 02. When the keys are released, these two-digit codes are no longer displayed.

To set the °F/°C indication and heat cycle rate:

1. If the temperature is displayed in °F, set the temperature setpoint to 52°F. If the room temperature is displayed in °C, set the temperature setpoint to 11°C.

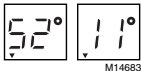

2. Press the ▲▼ keys simultaneously for more than one second to light all segments on display and to enter installer setup mode. When the keys are released, a two-digit software revision code is displayed.

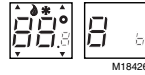

### OPTIONAL SYSTEM CHECKOUT

When the heat or cool outputs are turned on, the five-minute off-timer safety feature is bypassed.

When in steps 2 and 3 only, the ▼ key can be used to turn heat or cool outputs on and off. Change the SYSTEM switch setting to test heat or cool outputs. No action takes place if the system switch is in the Off position.

The following examples of system settings show a two digit software code on the display. The code shown is only an example; codes may vary.

System setting at Heat:

To turn heat on, press the ▼ key.



To turn auxiliary heat on, press the ▼ key.



To turn auxiliary heat off, press the ▼ key a third time.



To turn heat off, press the ▼ key a fourth time.



System setting at Cool:

To turn cool on, press the ▼ key.



To turn cool off, press the ▼ key.



3. Press the ▲ key. Factory information is displayed. A typical example is shown, but information displayed varies by model. This information is for factory use only.
4. Press the ▲ key again to display °C or °F.



- 5. Press the ▼ key to change the °C or °F indication.



M114689

NOTE: Stage-one heat and cool cycle rates are fixed at 3 cph. Only stage-two heat cycle rates are selectable.

- 6. Press the ▲ key to display the heat cycle rate of 3, 4, 5, 6, 9 or 12. If the desired cycle is displayed, see Table 1, press the ▲ key to exit the installer setup mode. To change the heat cycle rate, press the ▼ key to scroll between 3, 4, 5, 6, 9 and 12. Stop scrolling when the desired rate is displayed.



M114690

Table 1. Heat Cycle Rates.

System	Cycle Per Hour
Hydronic heat, condensing gas furnace <sup>a</sup>	3
Gas or oil forced air	6
Electric heat	9
Special applications <sup>b</sup>	4, 5, 12

<sup>a</sup>High efficiency furnace.

<sup>b</sup>Refer to equipment manufacturer's instructions.

- 7. Press the ▲ key to display cooling algorithm configuration default.

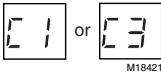

M118421

- 8. Press the ▲ key again to change cooling algorithm to C1 or C3.
  - C1 = Standard cooling algorithm.
  - C3 = Aggressive cooling algorithm (can cause overshooting).
- 9. Press the ▲ key again. Current configuration (CC) is displayed. A typical example is shown, but CC varies by model. (This information is for factory use only.)



M118420

- 10. Press the ▲ key to save all changes, exit installer setup mode and return to normal operation.

NOTE: After exiting installer setup mode, change the setpoint to the desired room temperature.

## CHECKOUT

### Heating

1. Slide the SYSTEM switch to Heat and the FAN switch to Auto.
2. Press and hold the ▲ key to raise the temperature setting several degrees above the room temperature. After approximately five minutes, the heating equipment should start.
3. Press the ▼ key to lower the temperature setting below the room temperature. Heating equipment should stop.

### Cooling



## CAUTION

**Equipment Damage Hazard.**  
Operating at too low of an outdoor temperature may cause compressor damage.

Do not operate cooling if outdoor temperature is below 50°F (10°C). Refer to manufacturer's recommendations.

- For compressor protection, allow the compressor to remain off for five minutes before restarting.
1. Slide the SYSTEM switch to Cool and the FAN switch to Auto.
  2. Press the ▼ key to lower the temperature setting several degrees below the room temperature. After approximately five minutes, the cooling equipment and fan should start.
  3. Press the ▲ key to raise the temperature setting above the room temperature. Cooling system should shut down.

### Fan

1. Slide the SYSTEM switch to Off and the FAN switch to On. The fan should run continuously.
2. Slide the FAN switch to Auto. The system turns the fan on and off with the equipment.

Make certain all equipment responds properly to the thermostat.

**Honeywell**

#### Automation and Control Solutions

Honeywell  
1985 Douglas Drive North  
Golden Valley, MN 55422

Honeywell Limited-Honeywell Limitée  
35 Dynamic Drive  
Scarborough, Ontario  
M1V 4Z9